



TAPES AND ADHESIVES

WE
DEVELOP
ROOFING
IDEAS

Tapes and adhesives



Self-adhesive tapes and adhesives for gluing as well as sealing roof membranes, vapour-barrier foils and building materials based on plastics, too.

› Application of Eurovent® DUO

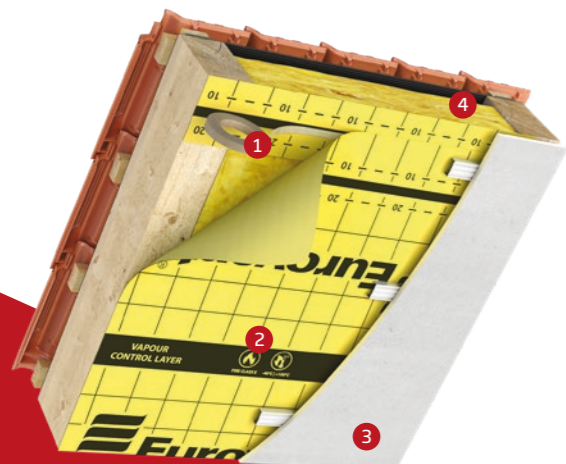
- 1 Eurovent® DUO
- 2 Eurovent® AKTIV
- 3 Plasterboard
- 4 Thermal insulation





- ### DUO
- Double-sided tape made of polyester mesh, coated on both sides with special adhesive based on acrylic dispersion
 - Used for joining vapour-barrier foils, roof membranes and other construction products based on plastics.

 > 5°C	 20 mm x 25 m 50 mm x 25 m	 14 rolls 12 rolls
---	--	--



- ### COMPRE X
- Single-sided expandable tape made of flexible polyurethane foam soaked in modified acrylic.
 - For sealing slots and joints in roof and general construction works.
 - Recommended for application in the areas of ridge, valley and roof windows.
 - Effectively seals slots along roof valleys to protect the roof against penetration of moisture, wind, rain and cold.
 - Binds with wood, brick, metal and smooth concrete.

 15/30 x 6 m; 15/40 x 4,3 m 15/50 x 4,3 m	 32 rolls 32 rolls 24 rolls
 > 5°C	



› Application of Eurovent® UNO COLD UV

- 1 Eurovent® UNO COLD UV
- 2 Eurovent® FASSADE
- 3 Eurovent® XSTRONG
- 4 Eurovent® FLEXOS X



UNO COLD UV

- Single-sided, tape made of PE mesh, reinforced with polyester fiber and special acrylic dispersion adhesive, additionally UV-stabilised.
- Used for sealing and repairing foils and membranes, also for insulation of technical passage.
- For sealing plastic materials based on polypropylene and polyethylene.
- Dedicated especially for application in minus temperatures and for use in areas exposed to UV rays.

 - 10°C	 24 months	 50 mm x 25 m	 12 rolls
--	---	--	--

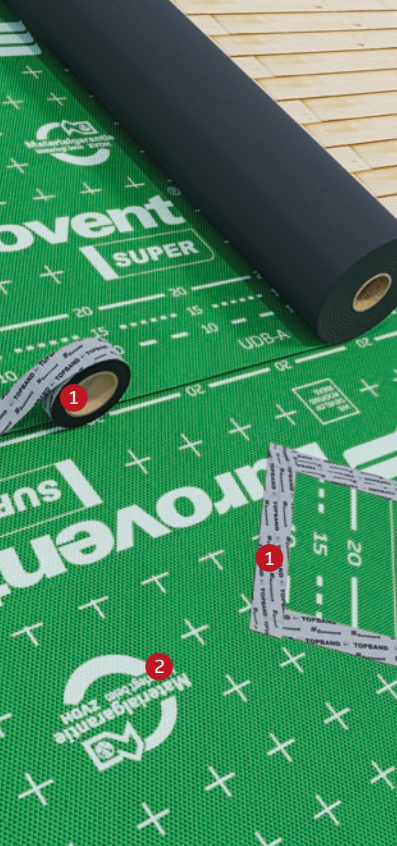

› Application of Eurovent® TOPBAND



› Application of Eurovent® UNO

- 1 Eurovent® TOPBAND
- 2 Eurovent® SUPER

- 1 Eurovent® UNO
- 2 Eurovent® AKTIV
- 3 Construction



- Universal, single-sided tape made of PE foil, reinforced with polyester fiber and special acrylic dispersion adhesive.
- Used for sealing and repairing foils and membranes made of plastic as well as for joining them with wood and metallized elements.

 > 5°C | 50 mm x 25 mm | 12 rolls

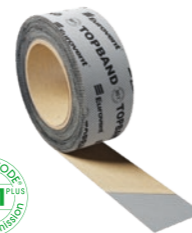

TOPBAND

- One-sided sealing tape made of polypropylene nonwoven and acrylic dispersion adhesive.
- Used for sealing and repairing roof membranes, wind insulation and other polypropylene based products.





 > 5°C | 50 mm x 25 mm | 12 rolls

UNO



BUTYL

- Double-sided, solvent-free tape, made on the basis of butyl, with a separating silicon paper layer.
- Used for joining and sealing vapour-barrier, roof and foundation foils and other construction products based on plastics.





 > 5°C | 15 mm x 25 mm | 16 rolls

BUTYL PRO

- Double-sided, solvent-free tape.
- Used as sealing tape under battens as well as for joining and sealing vapour-barrier foils, roof membranes and wind-barrier membranes in frame construction.





 > 5°C | 45 mm x 25 mm | 8 rolls



› Application of Eurovent® BUTYL PRO

- 1 Eurovent® BUTYL PRO
- 2 Eurovent® SUPER
- 3 Counter batten





› Application of Eurovent® BUTYL

- 1 Eurovent® BUTYL
- 2 Eurovent® MAXI
- 3 Chimney

UNISAN

- Universal, single-sided tape made of PE mesh, reinforced with polyester fiber and special acrylic dispersion adhesive.
- Used in construction, for bonding and repairing vapour-barrier foils as well as roofing membranes, for fixing installation damages.

		
> 5°C	60 mm x 25 rm 120 mm x 25 rm	10 rolls 4 rolls

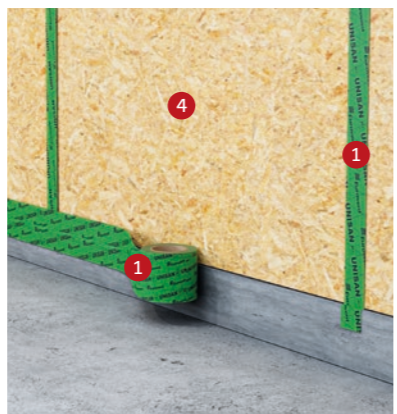
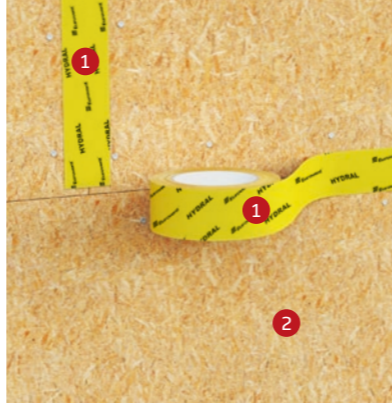
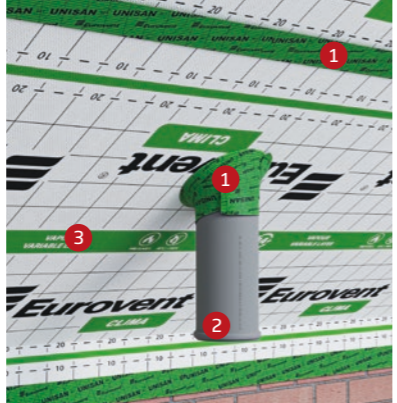

› Application of Eurovent® UNISAN

- 1 Eurovent® UNISAN
- 2 Eurovent® CLIMA
- 3 Venting pipe
- 4 OSB board

› Application of Eurovent® UNISAN

- 1 Eurovent® UNISAN
- 2 OSB board
- 3 Wall

HYDRAL

- Single-sided assembly tape made of waterproof paper and a special glue based on acrylic dispersion, solvent-free and chlorine - free.
- Used for gluing and repairing foils and vapour-barrier membranes as well as for sealing joints of wood-based materials and plaster boards.

		
> 5°C	50 mm x 25 rm	12 rolls



PUR

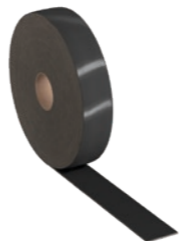

- One-sided sealing tape, made of polyethylene foam with closed cells structure and coated on one side with adhesive based on acrylic dispersion.
- Recommended for sealing and isolation of roof and building constructions.

		
> 5°C	40 mm x 25 rm	24 rolls



ALUFIX

- Single-sided metallized tape made of PE foil and special adhesive based on acrylic dispersion.
- Used for sealing and repairing foils and vapour-barrier membranes on the basis of aluminum and metallized surfaces.

		
> 5°C	50 mm x 25 rm 75 mm x 25 rm	36 rolls 24 rolls

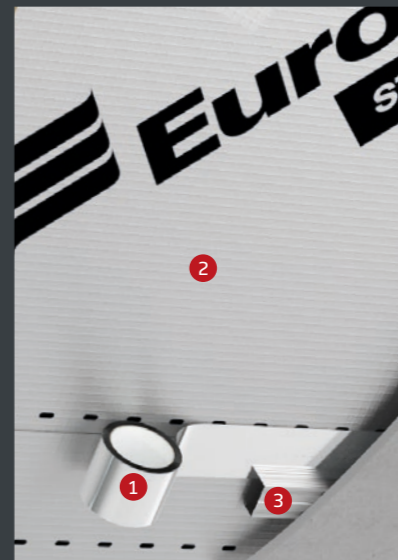
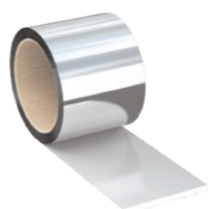

› Application of Eurovent® PUR

- 1 Eurovent® PUR
- 2 Eurovent® MAXI
- 3 Counter batten

› Application of Eurovent® ALUFIX

- 1 Eurovent® ALUFIX
- 2 Eurovent® STANDARD ALU
- 3 Construction

MULTI



- Highly adhesive, solvent-free and odourless general purpose adhesive, ideal for sealing vapour-barrier and buildings interiors. Strongly resistant to aging.
- Flexible and stretchable, susceptible to building movements - dilatation sealing. Suitable for plastering.



FLEXBIT

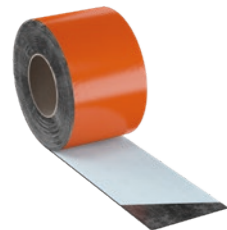

- Roofing tape made of aluminum foil and a bituminous glue.
- Used for repair and adhesion works in roofs in the chimney areas, roof windows, firewalls, roof valleys and ventilation elements.

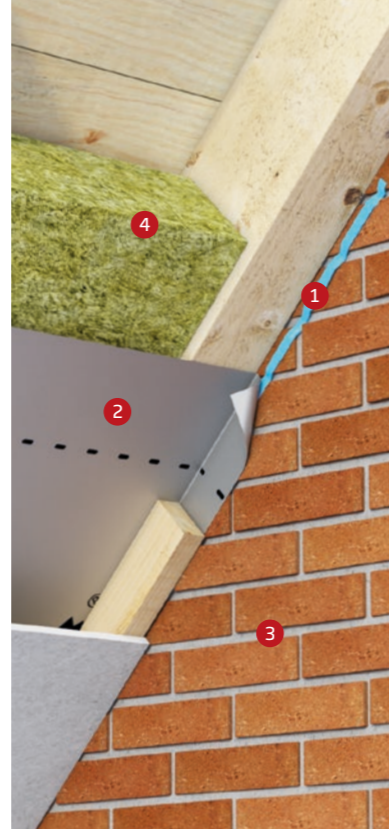
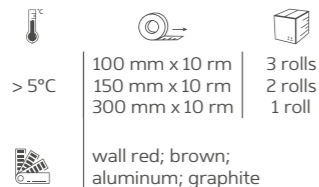

› Application of Eurovent® MULTI

- 1 Eurovent® MULTI
- 2 Eurovent® STANDARD ALU
- 3 Wall
- 4 Thermal insulation

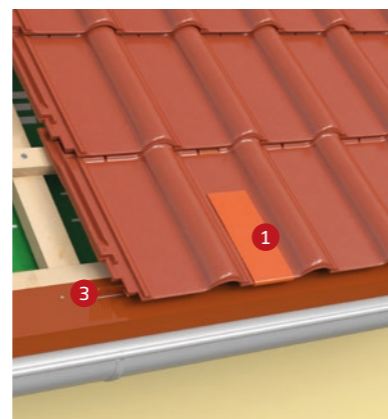
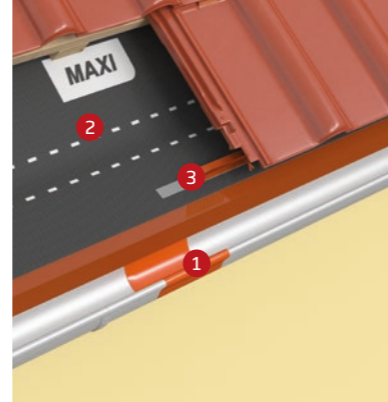

› Application of Eurovent® FLEXBIT

- 1 Eurovent® FLEXBIT
- 2 Eurovent® MAXI
- 3 Eurovent® COMB VENTI



Eurovent® THERMO 3

It is an efficient system of tapes and sealings suitable for the installation of window and doors in the so called "Warm Installation" technology.

Eurovent® Thermo 3

Reduces the costs of energy consumption, prevents cold bridges development, dedicated for window joinery in modern, passive, frame construction as well as in case of modernisation of the buildings already existing.



Elimination of mold and fungi.



Acoustic insulation.



Elimination of thermal bridges.



Protection against water and moisture.



ASSEMBLY - THERMO 3

SINGLE-LAYER WALL.

- 1 Eurovent® AKTIVBAND SK2
- 2 Montage foam or Eurovent® COMPRE 600
- 3 Eurovent® COMPRE 600
- 4 Wall
- 5 Jamb
- 6 Plaster
- 7 Window

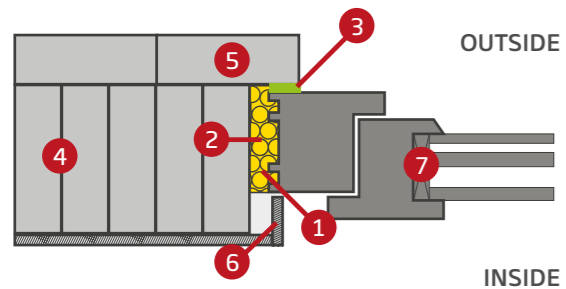

DOUBLE-LAYER WALL.

- 1 Eurovent® AKTIVBAND SK2
- 2 Montage foam or Eurovent® COMPRE 600
- 3 Eurovent® DIFFUBAND SK2
- 4 Eurovent® COMPRE 600
- 5 Wall
- 6 Thermal insulation
- 7 Plaster, facade
- 8 Window

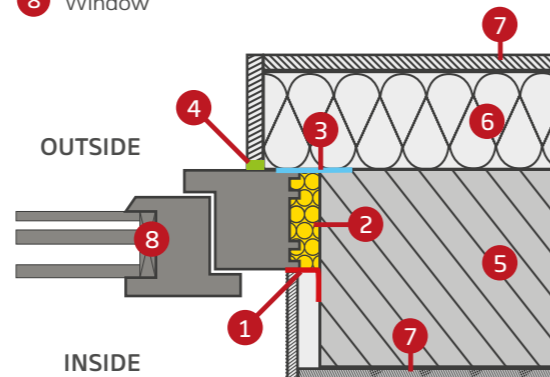

TIMBER FRAME WALL.

- 1 Eurovent® COMPRE 600
- 2 Eurovent® AKTIVBAND SK
- 3 Timber frame
- 4 Thermal insulation
- 5 Facade
- 6 Plasterboard
- 7 Window

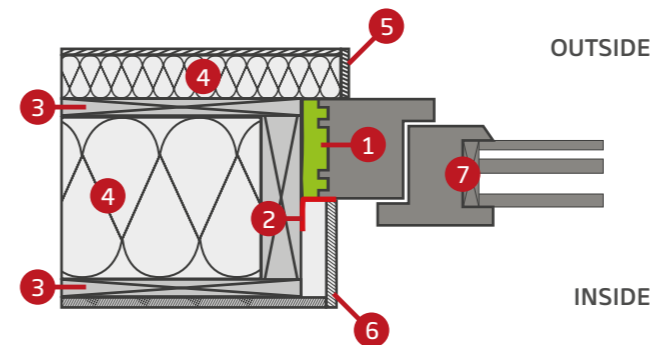

MULTI-LAYER WALL.

- 1 Eurovent® COMPRE 3W
- 2 Thermal insulation
- 3 Plaster
- 4 Clinker brick
- 5 Window
- 6 Wall

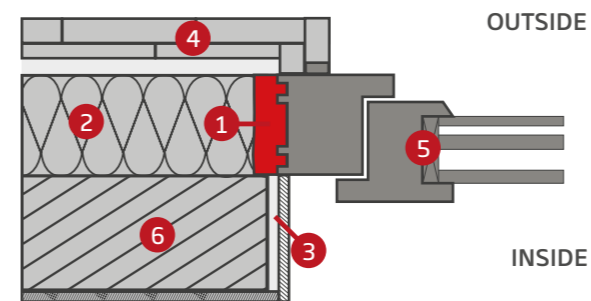

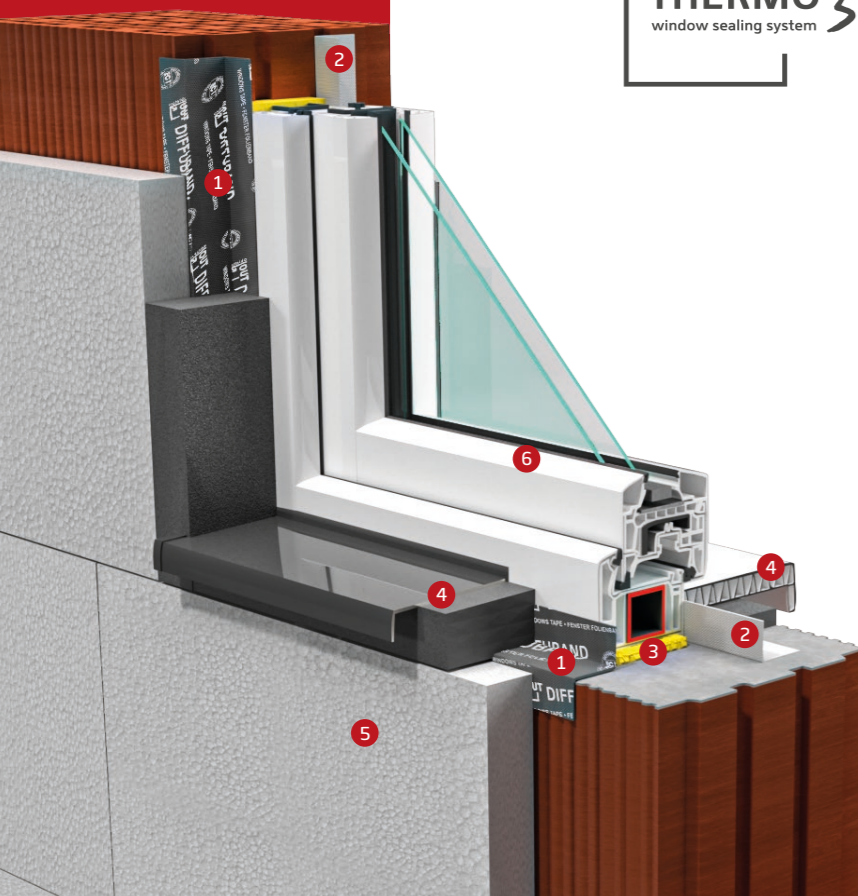

Window tapes

Airtight window tapes and expanding tapes for the installation of windows, doors and gates in layered technique "Warm Installation"

› Application of window tapes

- 1 Eurovent® AKTIVBAND SK
- 2 Eurovent® DIFFUBAND SK
- 3 Montage foam
- 4 Window
- 5 Thermal insulation
- 6 Window

AKTIVBAND SK



- Interior vapour-barrier window tape AKTIVBAND SK suitable for the insulation of window mounting holes, blinds and doors in the so called "Warm Installation" technology.
- Made from special nonwoven fabric as well as vapour-barrier film, coated on one side with a layer of adhesive on the whole surface which facilitates its application to the window frame and to the wall.
- Does not require extra adhesive or preparation for grounds priming.

 > 5°C	 70 mm x 25 rm 100 mm x 25 rm 150 mm x 25 rm	 1 roll 4 rolls
-----------	---	-----------------------

AKTIVBAND SK2



- Interior vapour-barrier window tape AKTIVBAND SK2 suitable for the insulation of window mounting holes, blinds and doors in the so called "Warm Installation" technology.
- Made from special nonwoven fabric as well as vapour-barrier film, coated on one side with a layer of adhesive on the whole surface.
- Equipped with an adhesive stripe 20 mm (SK2) on the other side which facilitates its application to the window frame and to the wall.
- Does not require extra adhesive or preparation for grounds priming.

 > 5°C	 70 mm x 25 rm 100 mm x 25 rm 150 mm x 25 rm	 1 roll 4 rolls
-----------	---	-----------------------



› Composition of Eurovent® AKTIVBAND SK & AKTIVBAND SK2

- 1 Silicon paper layer
- 2 Special acrylic adhesive layer - SK
- 3 Nonwoven fabric with vapour-barrier film
- 4 Additional adhesive strip - SK2





DIFFUBAND SK

- Exterior vapour-permeable window tape DIFFUBAND SK suitable for the insulation of window mounting holes, blinds and doors in the so called "Warm Installation" technology.
- Made from special nonwoven fabric, coated on one side with a layer of adhesive on the whole surface which facilitates its application to the window frame and to the wall.
- Does not require extra adhesive or preparation for grounds priming.

 > 5°C	 70 mm x 25 rm	 1 roll
	100 mm x 25 rm	4 rolls
	150 mm x 25 rm	

DIFFUBAND SK2

- Exterior vapour-permeable window tape DIFFUBAND SK2 suitable for the insulation of window mounting holes, blinds and doors in the so called "Warm Installation" technology.
- Made from special nonwoven fabric, coated on one side with a layer of adhesive on the whole surface.
- Equipped with an adhesive stripe 20 mm (SK2) on the other side which facilitates its application to the window frame and to the wall.
- Does not require extra adhesive or preparation for grounds priming.

 > 5°C	 70 mm x 25 rm	 1 roll
	100 mm x 25 rm	4 rolls
	150 mm x 25 rm	

› Composition of Eurovent® DIFFUBAND SK & DIFFUBAND SK2

- 1 Silicon paper layer
- 2 Special acrylic adhesive layer - SK
- 3 Vapour-permeable nonwoven fabric
- 4 Additional adhesive strip - SK2

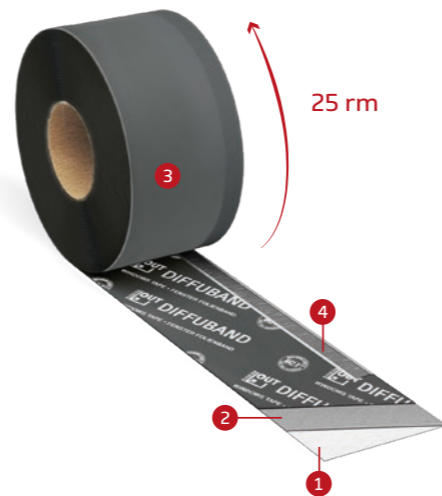

EMICODE®

It is a system of quality control and classification of building materials according to the level of emission of dangerous substances.

Materials classified as „very low emission“ have the **GEV EMICODE® EC1 PLUS** label, which offers the highest level of safety for healthy indoor air.



MPA

Expanding tapes Eurovent® received technical approval issued by the Research Institute of building materials and production technology (Materialprüfanstalt für das Bauwesen und Produktionstechnik Hannover/ MPA Hannover).

Tapes are classified as flame retardant materials in accordance with the standard **DIN 4102-1: 1998-05**.



DIN 4108/7

This is a standard that defines the airtightness of a building material or part of a building, which means that air does not pass through the element or to a limited extent.

These materials prevent the ventilation of the structure and ensure the tightness of the connection.





DIN 18542
According to



COMPRE 300

- Expanding tape made of flexible polyurethane foam soaked with modified acrylic.
- Flammability class B2.
- Sealing class ≥ 300 hPa.
- Suitable for the installation of windows, doors and garage doors. Moreover, for sealing holes, cracks and grouts in roofs, windows and elevations.
- It is recommended to protect it against long lasting activity of atmospheric factors.
- Especially recommended for the insulation of grouts in constructions with a jamb.
- Insulates against moisture, wind, rain, cold and acoustically.



> 5°C



> 300 hPa



black
grey*

*on order

› Technical data COMPRE 300

Tape	Width [mm]	Slit size [mm]	Roll length [m]	Box
10/2-3	10	2-3	12,5	48
15/2-3	15	2-3	12,5	32
20/2-3	20	2-3	12,5	24
15/3-6	15	3-6	10	32
20/3-6	20	3-6	10	24
15/4-8	15	4-8	8	32
20/4-8	20	4-8	8	24
15/5-10	15	5-10	8	32
20/5-10	20	5-10	8	24
15/7-12	15	7-12	6	32
20/7-12	20	7-12	6	24
25/7-12	25	7-12	6	19
30/7-12	30	7-12	6	16
20/9-15	20	9-15	4,3	19
25/9-15	25	9-15	4,3	19
30/9-15	30	9-15	4,3	16
40/10-18	40	10-18	4	18
30/14-24	30	14-24	4	16
40/14-24	40	14-24	4	12



DIN 18542
According to



COMPRE 600

- Expanding tape made of flexible polyurethane foam soaked with modified acrylic.
- Flammability class B1.
- Sealing class ≥ 600 hPa.
- Suitable for the installation of windows, doors and garage doors as well as for technical sealings in elevations, windows, doors and roofs.
- Resistant to heavy rains as well as to UV radiation, does not require protection against the activity of atmospheric factors.
- Insulates against moisture, wind, rain, cold and acoustically.
- Especially recommended for frame construction, passive houses and for constructions with a jamb.



> 5°C



> 600 hPa



black

› Technical data COMPRE 600

Tape	Width [mm]	Slit size [mm]	Roll length [m]	Box
15/7-12	15	7-12	8	32
20/7-12	20	7-12	8	24
30/7-12	30	7-12	8	16
20/9-15	20	9-15	4,3	24
25/9-15	25	9-15	4,3	19
30/9-15	30	9-15	4,3	16
35/18-32	35	18-32	2	14
40/24-40	40	24-40	2	12
50/24-40	50	24-40	2	9

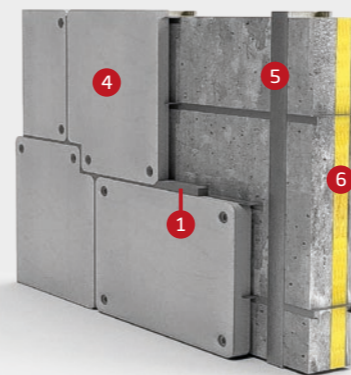

Eurovent® COMPRE 600

Used as waterproof and windproof sealings in prefabricated elements built from concrete, metal and wood, clinker facades, as a joining of shutterings, or a sealing of outer joints. It is also suitable as an insulation of slits by window, door joinery, as well as in constructions with jamb. The tape in class > 600 hPa does not require to be covered after its installation, as it is completely resistant to long-lasting UV radiation.

› Application of Eurovent® COMPRE 600

- 1 Eurovent® COMPRE 600
- 2 Eurovent® WALL PROTECT
- 3 Wood log
- 4 Facade
- 5 Wall
- 6 Thermal insulation

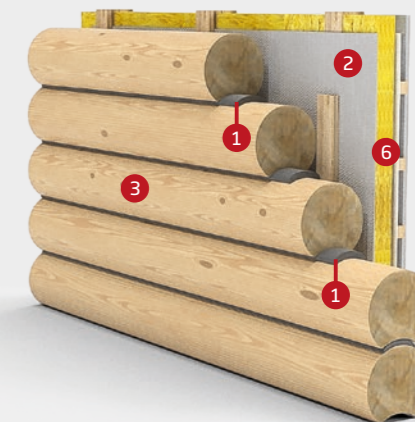



DIN 18542
According to



COMPRE 3W

- Multifunctional expanding tape made of flexible polyurethane foam soaked with synthetic resin.
- Flammability class B1.
- Sealing class ≥ 600 hPa.
- Resistant to atmospheric factors and UV radiation.
- Dedicated for the installation of windows, doors and garage doors as well as for sealings of grouts and installation cracks.
- Ensures thermal and acoustic insulation, insulates against moisture, wind and rain.
- Replaces installation foam and window tapes when installing windows, doors and garage doors too.



$> 5^{\circ}\text{C}$



> 600 hPa

Tape	Window frame [mm]	Width [mm]	Slit size [mm]	Roll length [m]	Box
64/5-10	70	64	5-10	8	7
74/5-10	80	74	5-10	8	6
84/5-10	90	84	5-10	8	5
64/10-20	70	64	10-20	6	7
74/10-20	80	74	10-20	6	6
84/10-20	90	84	10-20	6	5

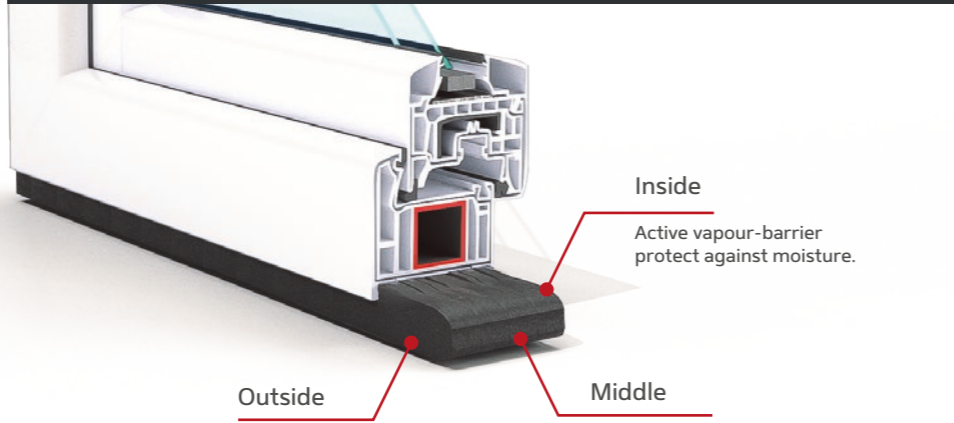

Outside
Wind and rain insulation,
sealing ≥ 600 hPa.

Middle

Thermal and acoustic insulation up to 59 db. Filling of joints, elimination of thermal bridges.

Inside

Active vapour-barrier
protect against moisture.

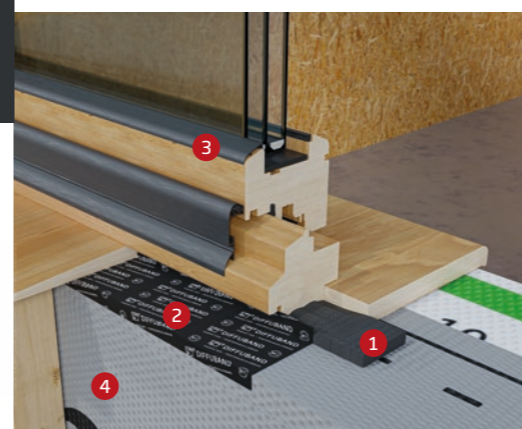
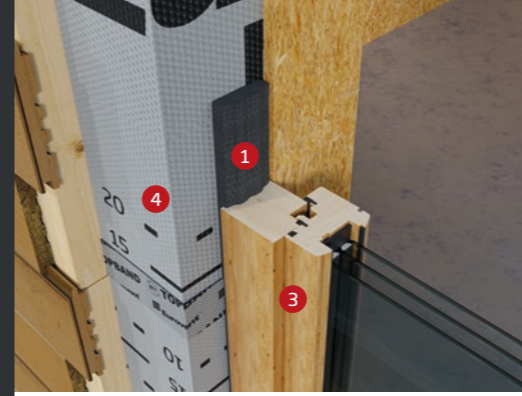

> Application of Eurovent® COMPRE 3W

- 1 Eurovent® COMPRE 3W
- 2 Eurovent® DIFFUBAND
- 3 Window
- 4 Eurovent® WALL PROTECT 3



> Application Eurovent® CORNER PRO

- 1 Eurovent® CORNER PRO
- 2 Eurovent® WALL PROTECT 3
- 3 Eurovent® TOPBAND
- 4 Facade



CORNER PRO

- Sealing coin is used as a sealing element of a membrane and foil joinings in doors and windows coignes.
- Recommended for frame and module constructions, as a complementary element of insulating systems.



- 30°C do
+100°C



100 mm x 120 mm
160 mm x 120 mm



50 pcs.

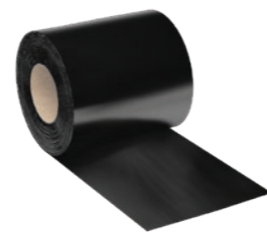

EPDM PRO

- External sealing tape from synthetic rubber of a structure increasing adhesiveness.
- Used for outside vertical and horizontal damp proof insulation as well as for sealing connections between doors, windows, windowsills, elevation and a building construction.
- Recommended for insulation of terraces and balconies areas.
- Irreplaceable by warm installation of window and aluminium joinery especially in the places exposed to increased moisture activity.
- The tape of gauge 1,1 mm may be applied in places of direct contact with base surface



0,75 mm
1,1 mm



50 mm; 60 mm;
100 mm; 110 mm;
130 mm; 150 mm;
200 mm; 250 mm;
300 mm; 400 mm;
500 mm x 25 mm



60 mm: 5 rolls
50; 100; 150;
200 mm: 4 rolls
others: 2 rolls

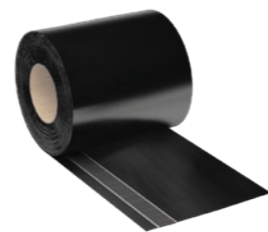

EPDM PRO SK

- External sealing tape from synthetic rubber of a structure increasing adhesiveness.
- Integrated with a self-adhesive butyl strip.
- Used for outside vertical and horizontal damp proof insulation as well as for sealing connections between doors, windows, windowsills, elevation and a building construction.
- Recommended for insulation of terraces and balconies areas.
- Irreplaceable by warm installation of window and aluminium joinery especially in the places exposed to increased moisture activity.
- The tape of gauge 1,1 mm may be applied in places of direct contact with base surface.



0,75 mm
1,1 mm



100 mm; 150 mm;
200 mm; 250 mm;
300 mm; 400 mm;
500 mm x 25 mm



100-200 mm: 4 rolls
others: 2 rolls

› Application of Eurovent® EPDM PRO

- 1 Eurovent® EPDM PRO
- 2 Eurovent® AKTIVBAND SK
- 3 Montage foam
- 4 Terrace
- 5 Terrace window
- 6 Floor inside

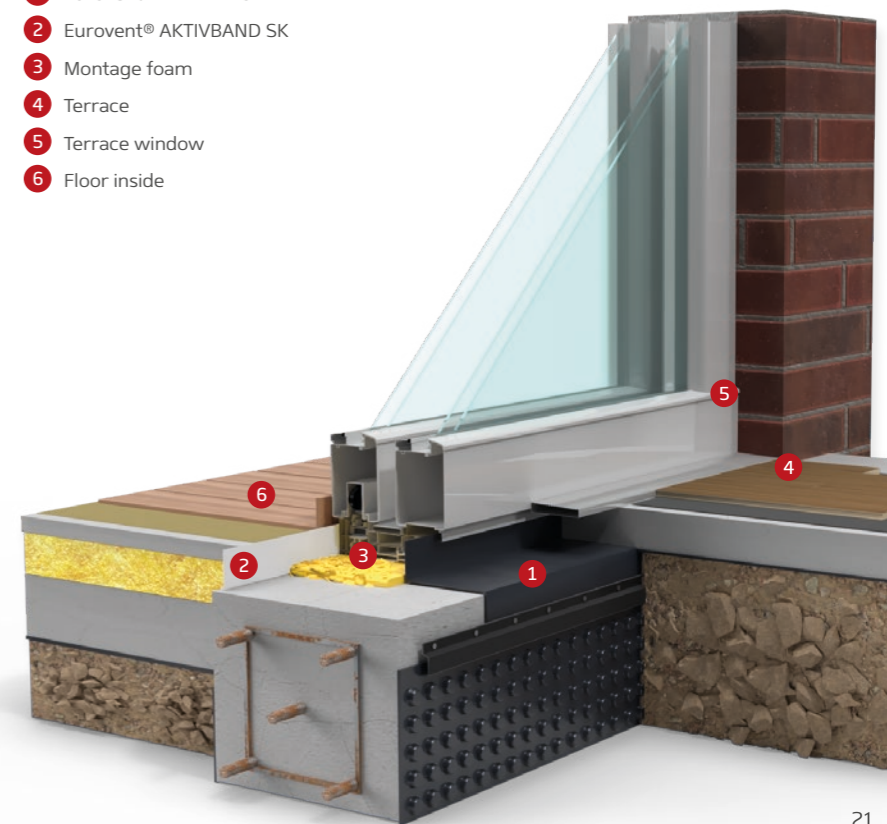

Sealing collar

Sealing collar, called as sealing sleeves in other words, serve for durable sealing of cable, solar passages and pipes.



SEAL

- Sealing collar used for solar connections and different pipe systems, e.g. for sealing heating, sewage, ventilation pipes that drain rainwater, etc.

	Ø		
R1	15-22 mm	150 x 150 mm	10 pcs.
R2	25-32 mm	150 x 150 mm	10 pcs.
R3	40-55 mm	230 x 230 mm	10 pcs.
R4	50-72 mm	230 x 230 mm	4 pcs.
R5	72-90 mm	230 x 230 mm	4 pcs.
R6	100-110 mm	320 x 320 mm	4 pcs.
R7	100-125 mm	350 x 350 mm	4 pcs.
R8	125-135 mm	320 x 320 mm	4 pcs.



MINI SEAL

- Sealing collar used for cable connections of diameters 4-8 mm and 8-12 mm

	Ø		
K1	4 - 8 mm	150 x 150 mm	10 pcs.
K2	8 - 12 mm	150 x 150 mm	10 pcs.



MULTI SEAL

- Six-ducts sealing collar designed for quick cable connections sealing. Used for cables of diameter 4-11 mm and pipes of 8-12 mm diameter

	Ø		
KM1	6 x 4 - 11 mm	230 x 230 mm	10 pcs.
RM2	6 x 16 - 25 mm	320 x 320 mm	10 pcs.

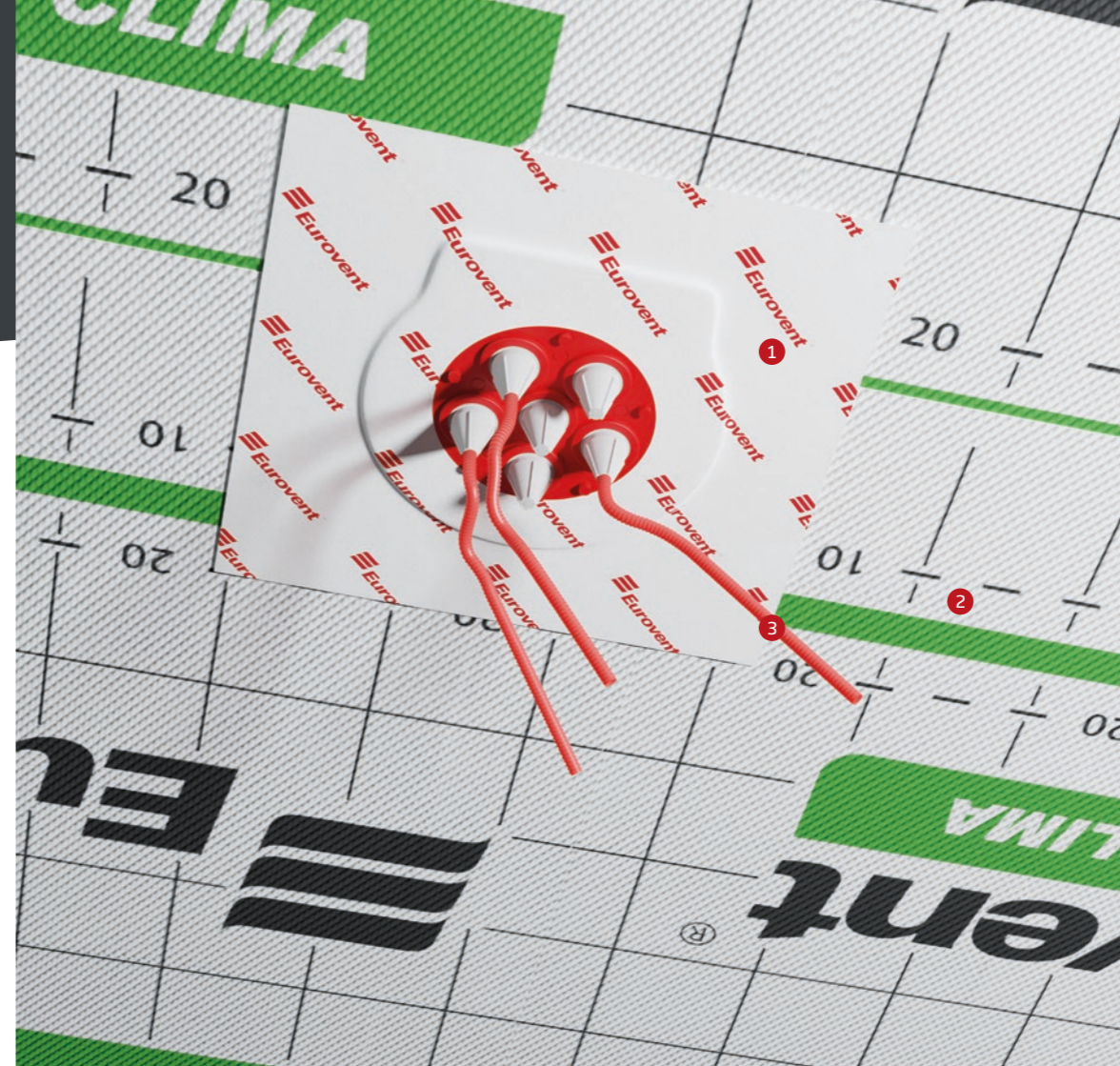

› Application of Eurovent® MULTI SEAL

- 1 Eurovent® MULTI SEAL
- 2 Eurovent® CLIMA
- 3 Cable bundles sheath

› Durable sealing

- cable connections
- solar connections
- pipes connections

www.eurovent.de

All the information has been advertised in good faith, on the basis of our best knowledge, research and a whole range of experiences. The information does not constitute any sales proposal within the meaning of Civil Code. We reserve the right of possible technical changes as well as certain mistakes and errors in the print.

The reprint edition, also in the form of extracts, only with the Eurosystem Polska Sp. z o.o. Sp. K consent.