



**WE  
DEVELOP  
ROOFING  
IDEAS**



is a long time experience in designing, manufacturing and marketing products dedicated to the insulation and ventilation of the pitched roof and facades. In our products range there are over 350 products mainly roofing membranes, house wraps, vapour barriers and roofing accessories. Our products offer is additionally equipped with the foundation and drainage membranes for vertical and horizontal waterproofing of the residential and commercial buildings.



German Quality and Technology

# INDEX

Technology

6/11

SYSTEM SK2

24

Wind zones

86

Sealing tapes

110/111

Snow zones

150/152

Marketing, POS

186/189

Yourbrand®

211

Iconography

215

ROOF  
MEMBRANES

14/29

VAPOUR BARRIER  
MEMBRANES

33/45

WIND BARRIER  
MEMBRANES

47/53

INSULATING  
FOILS

56/64

ROOF  
ACCESSORIES

67/173

FOUNDATIONS  
FOILS

174/185

TECHNICAL  
DATA

190/208



# › Roof system Eurovent®

roof membranes and accessories

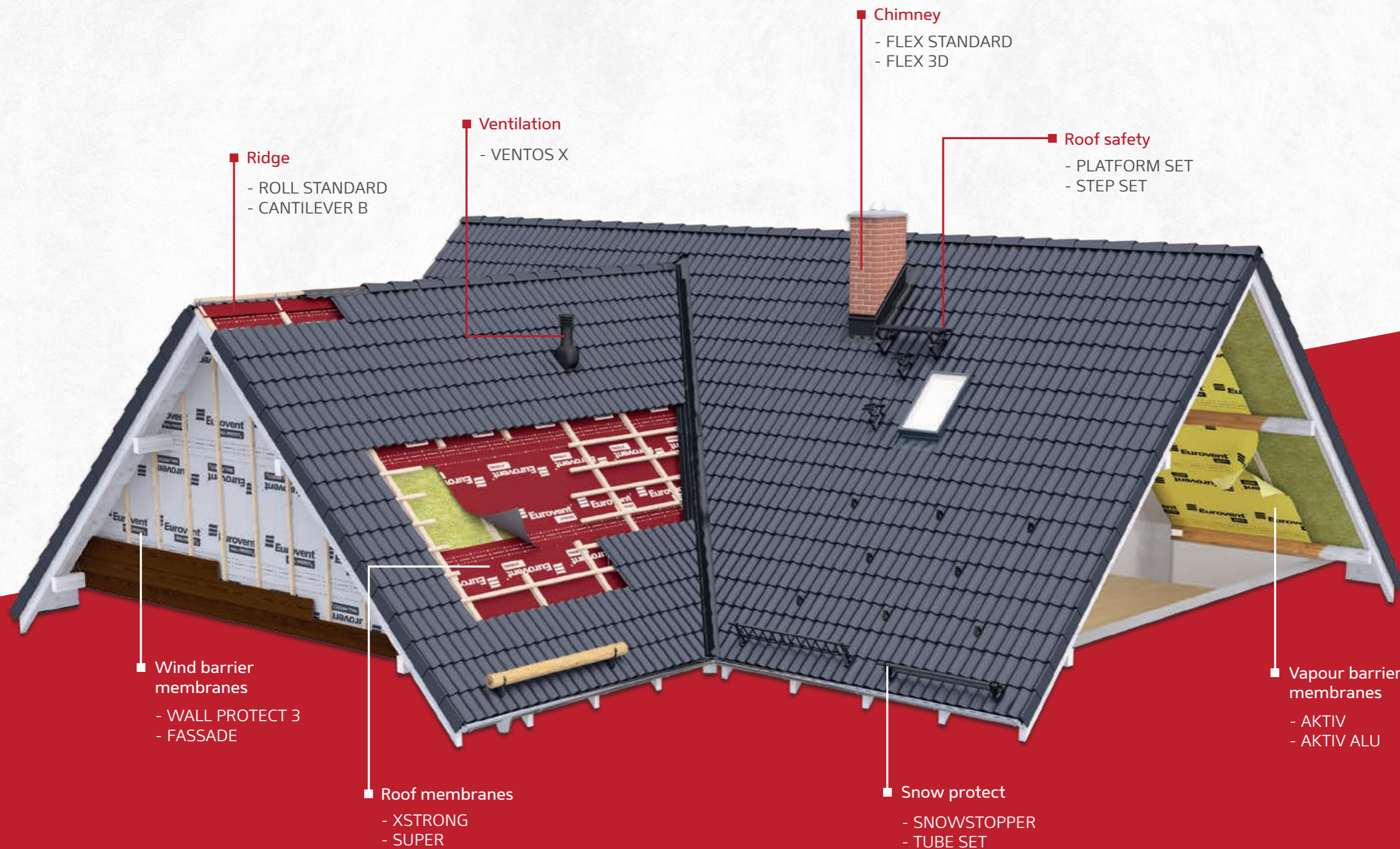





## Eurovent® Roof Membranes

Both continuous construction technology development, as well as constant appearance of various purposes the high vapour permeable membranes are used for, contribute to the generation of a need to use plenty of complicated technologies for their production. Here, we would like to make you more familiar with them. The Eurovent® roof membranes are characterised by great durability and resistance to atmospheric factors. The high quality polypropylene nonwovens we use are equipped with a high density, uniform distribution of very thin fibres, due to which - they achieve perfect mechanical parameters, what has a crucial meaning in case of roof products.

## Eurovent® FUNCTIONAL FILM

The core of Eurovent® Roofing Membranes that are manufactured in THERMOBONDING and HOTMELT technology is microporous functional film. It is extremely thin film made of polymer and chalk  $\text{CaCO}_3$  which consists over 1 mld micropores per  $\text{cm}^2$ . The presence of micropores provides the film with unusual qualities in the forms of watertightness, vapour permeability and air tightness (wind resistance). Additionally, the functional film is stabilised against the UV. Due to the fact, the whole laminate has an increased resistance to UV radiation.

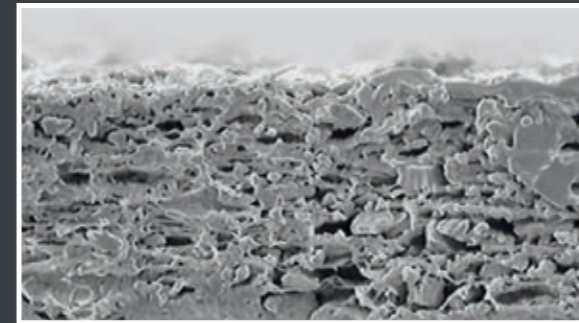

Functional film – the side view of 2000x zoom

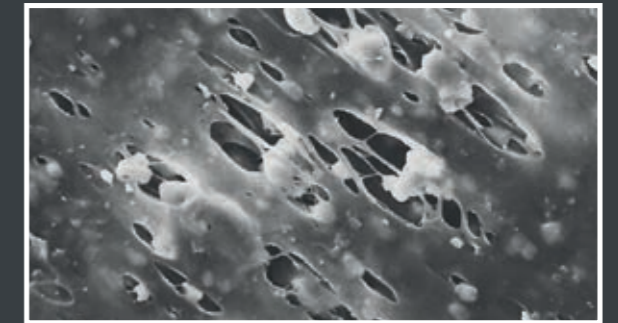

Functional film – the plan view of 10 000x zoom

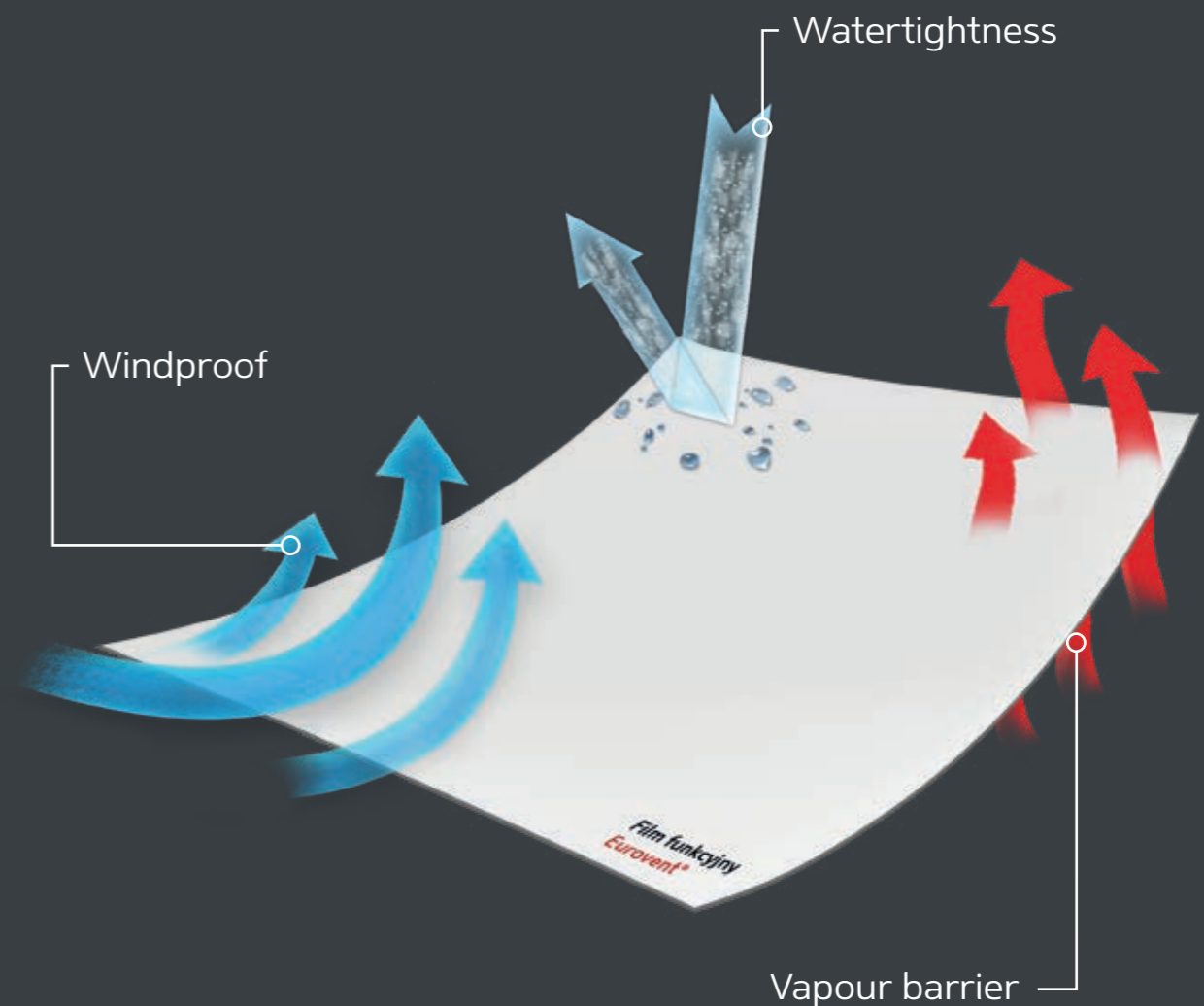



## THERMOBONDING

Thermal laminating technology is one of the best and most experienced technologies used worldwide for production of the three-layers roof membranes of chemically uniform fibre composition. Thermobonding is a type of thermal process of bonding several layers of plastic included in the laminate composition, with the use of high temperature and laminating calenders impacting on the laminated layers with high pressure. No additional substances are used in this technology, apart from high temperature, what makes the new laminates, produced in this way, very strong and durable. What is even more, thanks to the high temperature applied in the production process, they perform well in extreme temperatures, that occur in the roof and attic areas.

Membranes products in the THERMOBONDING technology:

BASIC  
CLASSIC  
HOME PRO  
MAXI  
MAXI PLUS  
SUPER  
COMFORT  
WALL PROTECT 3  
AKTIV ALU  
AKTIV 3

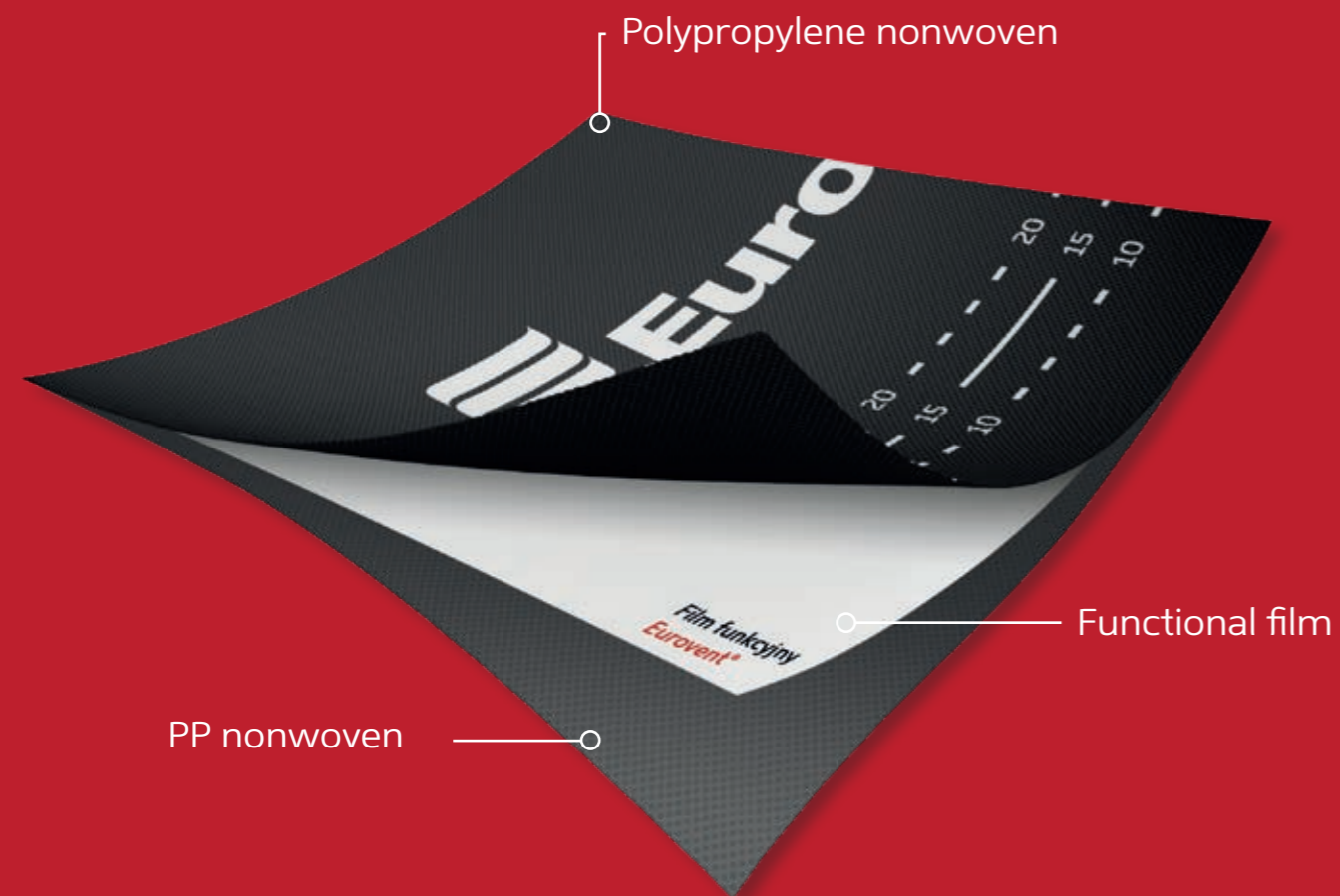

## HOTMELT

The gluing technology is less popular in the construction branch than the thermobonding, however indispensable as far as the production of different chemical composition and different qualities products are concerned. HOTMELT is about joining laminate layers with hot melted adhesive, that is evenly put on particular layers and then pressed by laminating calenders. The technology is most often used in the production of four-layers roof membranes, where the joined polypropylene nonwovens, functional film and polyethylene reinforcing mesh that provides the membrane with mechanical resistance.

Membranes products in the HOTMELT technology:

STRONG  
VSTRONG  
XSTRONG  
CLIMA X

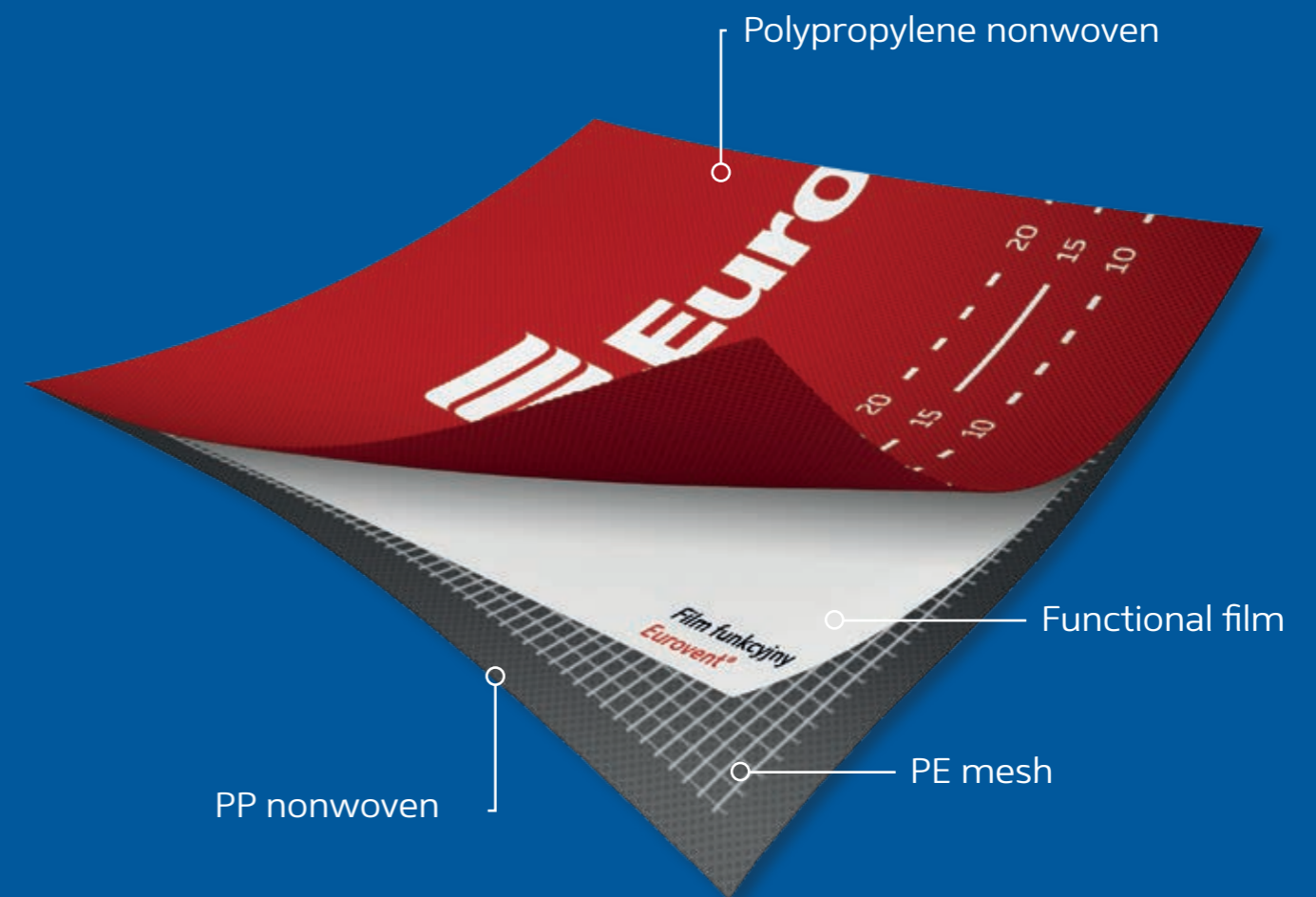



## COATING

The COATING technology has been widely used in the construction sector for many years and is constantly developed. As far as this technology is concerned, there are a few variations to be listed.

The first one is FOAM COATING, a technology of applying foamed polyacrylic onto the fabric or applying polyurethane onto the fabric where firstly polyurethane is submitted to special thermal processing that makes it porous. In this way we are able to achieve the vapour permeability function keeping the watertightness at the same time. With the use of this technology, typical products for sloping roofs are produced. The second variation of the coating technology is EXTRUSION COATING, the technology of applying liquid polymer onto the fabrics and bonding them with each other, allows creating multi-layered products, also the reinforced ones.

The COATING technology enables the production of a wide range of products such as: reinforced, vapour-permeable, vapour-barrier, metallized foils as well as facade products, which are highly required to be highly resistant to UV radiation.

Membranes products in the Foam Coating technology:

MAGNUM

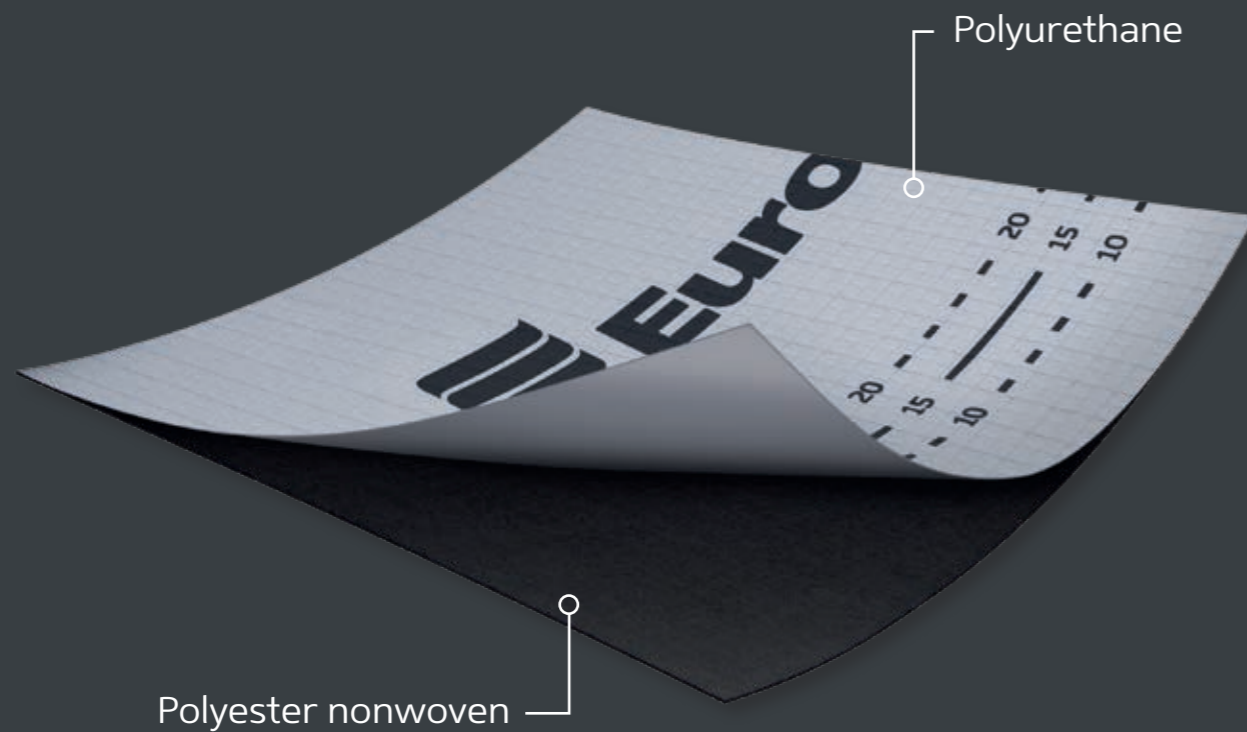

Membranes products in the EXTRUSION COATING technology:

- Two-layered products

FASSADE  
STRATOS  
CLIMA  
AKTIV FR  
WALL PROTECT FR

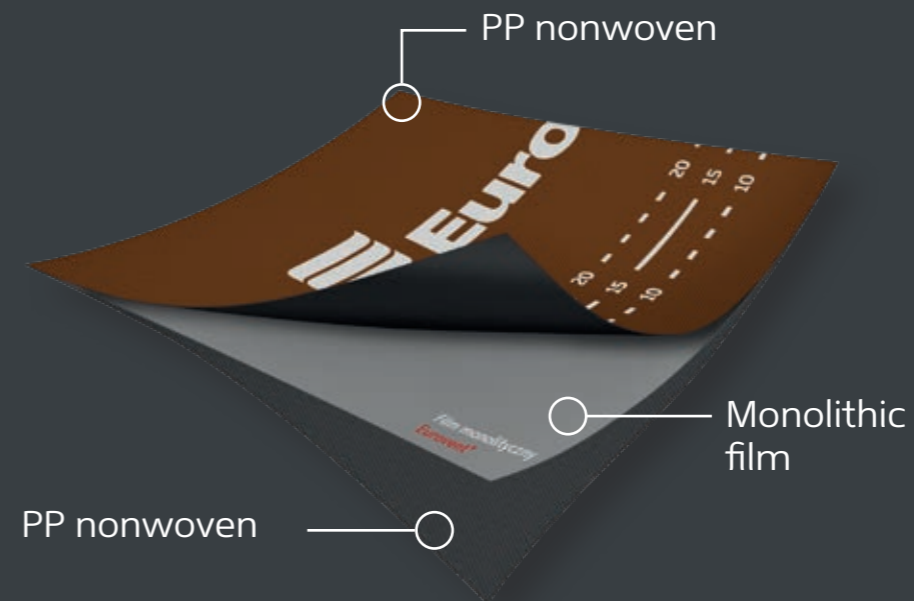

Membranes products in the EXTRUSION COATING technology:

- Three-layered products

MONO

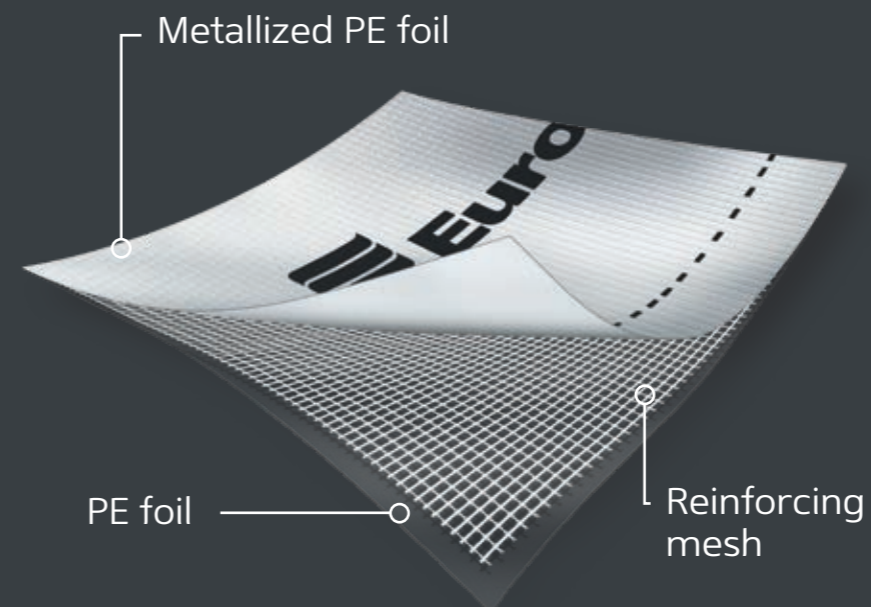

Foil products in the EXTRUSION COATING technology:



- Three-layered products

STANDARD  
STANDARD N  
SPECIAL  
SPECIAL FR<sub>5000</sub>  
SPECIAL N  
SPECIAL N FR<sub>5000</sub>  
STANDARD ALU  
ALUFLOOR



# Eurovent Worldwide



-  Company
-  Sales Partners



25 YEARS OF  
EXPERIENCE



48 COUNTRIES



250 STRATEGY  
CLIENTS



350 PRODUCTS  
IN OFFER

- |  |            |             |            |                        |                   |
|--|------------|-------------|------------|------------------------|-------------------|
|  |            |             | Denmark    | Poland                 | Slovakia          |
|  |            |             | Austria    | Hungary                | Greece            |
|  |            | Switzerland | Italy      | Netherlands            | Morocco           |
|  |            | France      | Albania    | Serbia                 | Spain             |
|  | Ukraine    | Moldova     | Latvia     | Czech Republic         | Romania           |
|  | USA        | Belarus     | Lithuania  | Norway                 | Russia            |
|  | Belgium    | Estonia     | Croatia    | Slovenia               | United Kingdom    |
|  | Bulgaria   | Finland     | Malaysia   | Azerbaijan             |                   |
|  | Macedonia  | Turkey      | Uzbekistan | Sweden                 | Ireland           |
|  | Germany    | Japan       | Georgia    | Taiwan                 | Republic of Korea |
|  | Kyrgyzstan | India       | Canada     | Bosnia and Herzegovina |                   |





## › Roof membranes

Highly vapour-permeable roof membranes are used as an insulating layer for ceramic, concrete roof tiles, steel roof tiles, flat sheet metals and bituminous shingle.



ORANGE

BLACK

### BASIC

- Three-layer, highly vapour-permeable roof membrane.
- For insulated and ventilated pitched roofs.
- Recommended for roofs without full sarking.
- Available in the SYSTEM SK2.



ca. 100 g/m<sup>2</sup>



ca. 0,02 m



1,5 m x 50 rm



50 Rolls

### CLASSIC

- Three-layer, highly vapour-permeable roof membrane.
- For insulated and ventilated pitched roofs.
- Used also for fully sarked roofs.
- Available in the SYSTEM SK2.



ca. 120 g/m<sup>2</sup>



ca. 0,02 m



1,5 m x 50 rm



50 Rolls

› Application roof membranes in the rafter non-sarked technique

- |                      |                  |
|----------------------|------------------|
| 1 Eurovent® BASIC    | 6 Counter batten |
| 2 Eurovent® PUR      | 7 Batten         |
| 3 Thermal insulation |                  |
| 4 Rafter             |                  |
| 5 Vapour barrier     |                  |

Recommended membranes:

- |             |           |
|-------------|-----------|
| • BASIC     | • STRONG  |
| • CLASSIC   | • SUPER   |
| • HOME PRO  | • VSTRONG |
| • MAXI      | • XSTRONG |
| • MAXI PLUS | • MONO    |

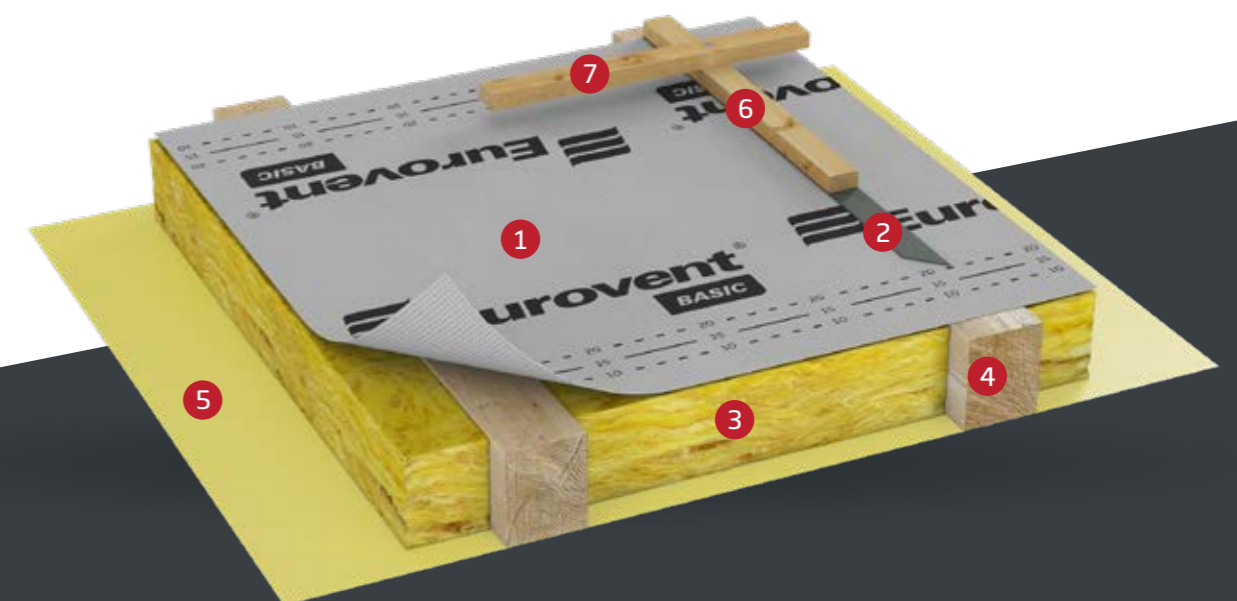









## HOME PRO





- Three layer water vapour highly permeable airtight premium housewrap and roofing underlay.
- Used as the underlay on the slope roof and as the housewrap on the facade, in the timber, brick, concrete and prefabricated construction, timber framing, CLT, passive houses and full sheathing.
- Available in the SYSTEM SK2.

 ca. 135 g/m<sup>2</sup> | 
  ca. 0,02 m | 
  1,5 m x 50 rm | 
  3,0 m x 50 rm\* | 
 50 Rolls



## MAXI





- Three-layer, highly vapour-permeable roof membrane.
- Resistant to tearing.
- For insulated and ventilated pitched roofs.
- Used also for fully sarked roofs and frame houses.
- Available in the SYSTEM SK2.

 ca. 140 g/m<sup>2</sup> | 
  ca. 0,02 m | 
  1,5 m x 50 rm | 
  50 Rolls



## MAXI PLUS





- Three-layer, highly vapour-permeable roof membrane.
- Resistant to tearing.
- For insulated and ventilated pitched roofs.
- Used also for fully sarked roofs and frame houses.
- Available in the SYSTEM SK2.

 ca. 150 g/m<sup>2</sup> | 
  ca. 0,02 m | 
  1,5 m x 50 rm | 
  50 Rolls



## STRONG

- Four-layer, highly vapour-permeable roof membrane, reinforced with PE mesh.
- Available in three different colours.
- Extremely resistance to tearing.
- For insulated and ventilated pitched roofs.
- Used also for fully sarked roofs and frame houses.
- Available in the SYSTEM SK2.

 ca. 160 g/m<sup>2</sup> | 
  ca. 0,02 m | 
  1,5 m x 50 rm | 
  40 Rolls

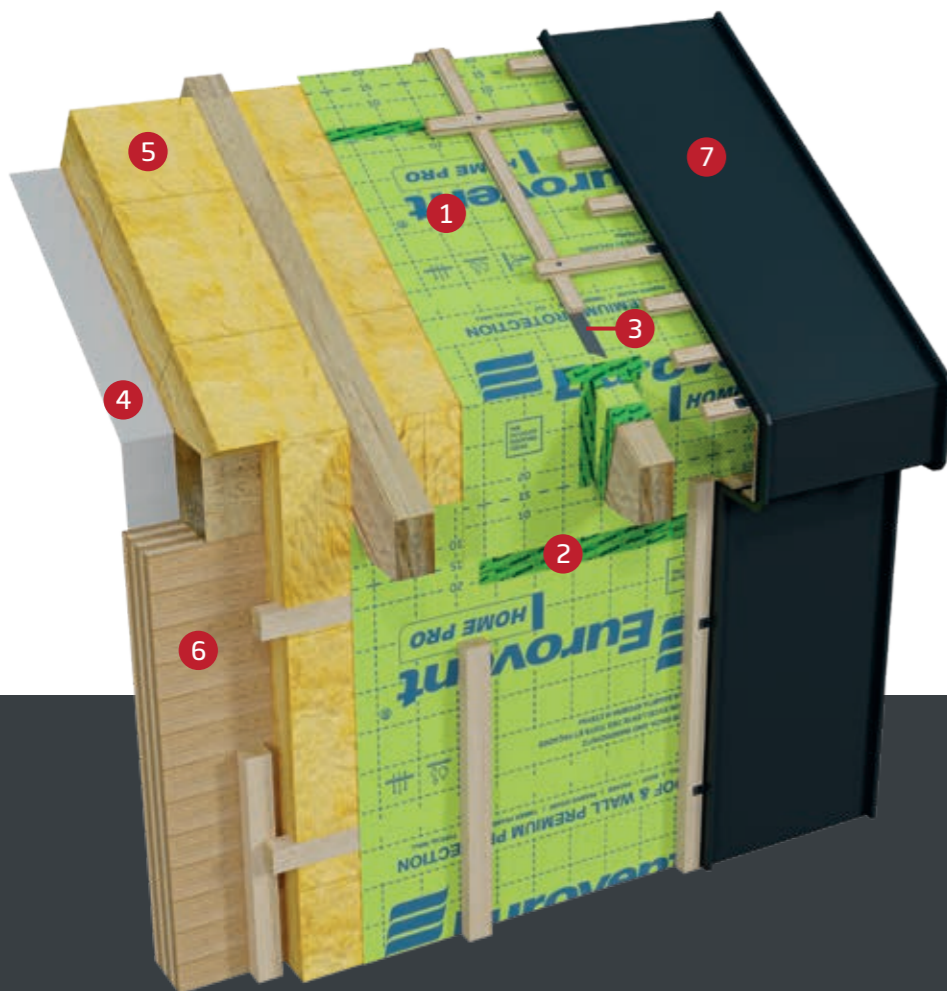

### › Eurovent® HOME PRO

- 1 Eurovent® HOME PRO
- 2 Eurovent® UNISAN
- 3 Eurovent® PUR
- 4 Eurovent® CLIMA
- 5 Thermal insulation
- 6 CLT
- 7 Metal panels

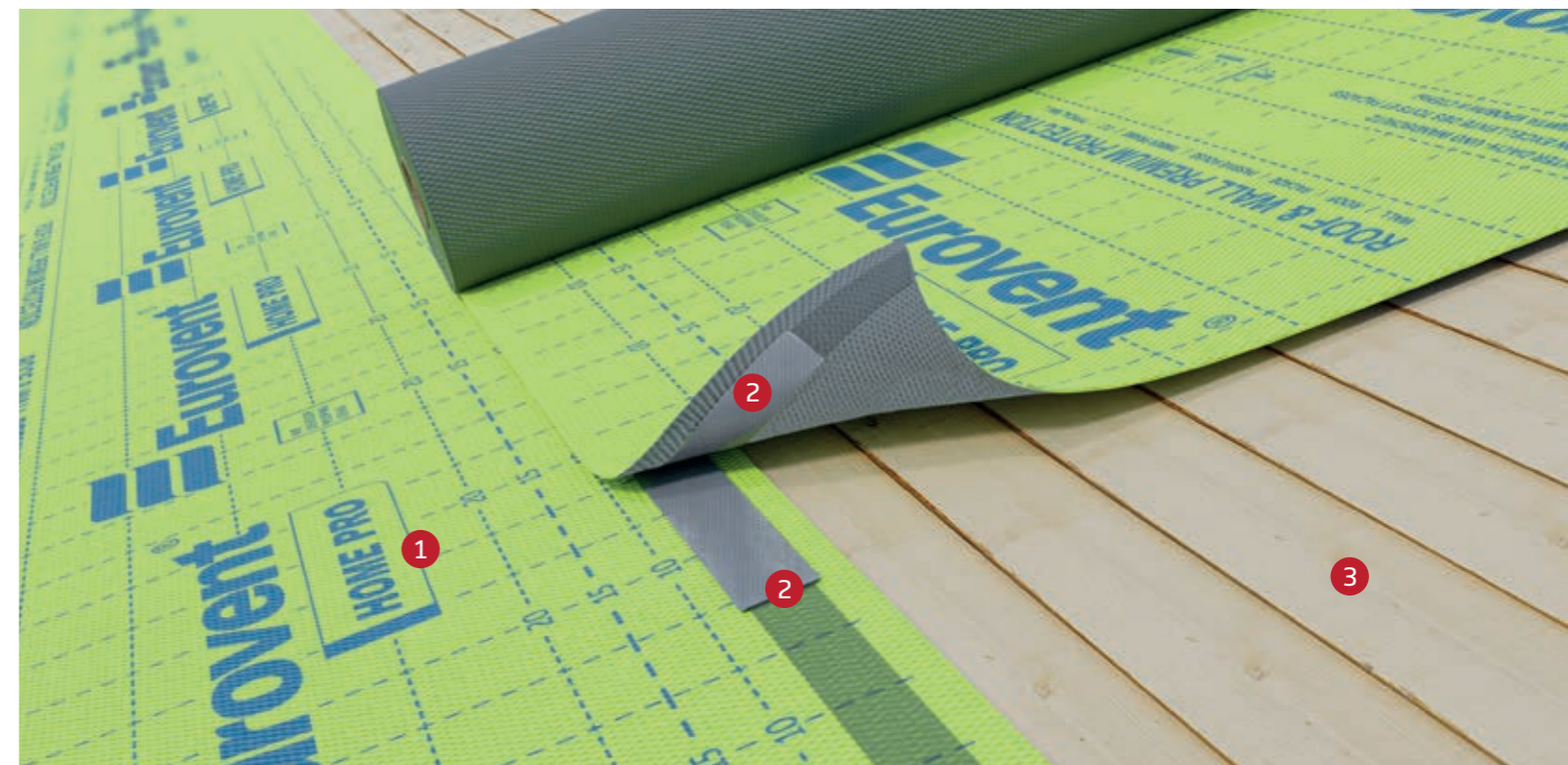

### › Eurovent® HOME PRO & SYSTEM SK2

- 1 Eurovent® HOME PRO
- 2 Eurovent® SYSTEM SK2
- 3 Full sheathing

\* on order.





# VAPOUR-PERMEABILITY (WDD)

Vapour-permeability is the ability for permeating water vapour that penetrates through particular material. The parameter is formulated in  $\text{g/m}^2/24\text{h}$ , which stands for the quantity of the water vapour that goes through the material and is given in grams per square meter per 24h. As far as our products are concerned that means the quantity of the water vapour that goes through a square meter of the roof membrane through 24 hours. A high vapour-permeability prevents against moisture and condensation generated in the building and protects the roof against changes responsible for lowering its parameters, what could cause permanent defects.

Moreover due to the use of vapour-permeable roofing membranes there is no need for keeping any venting slot between a roof membrane and thermal insulation. In addition, it counteracts its excessive cooling down, what in turn has a positive influence on the reduction of the energy costs, improving the energy effectiveness used for heating a building.

### ATTENTION:

- The WDD is given in  $[\text{g/m}^2/24\text{h}]$ .
- WDD is a relative unit.
- WDD is dependable from the temperature, humidity and the atmospheric pressure.

Division of membranes and vapour-permeable foils according to the  $S_d$  value:

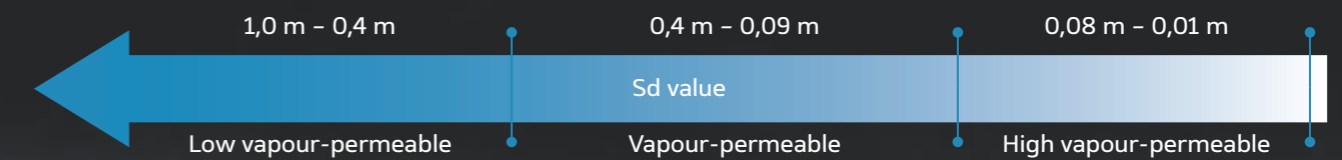

Division of membranes and vapour-permeable foils according to the WDD value:

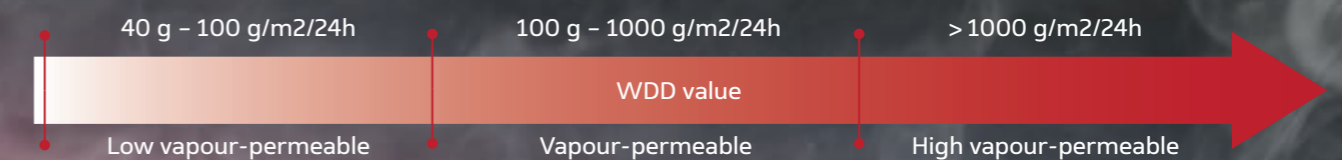





## SUPER

- RED
- GREEN
- BLACK

- Three-layer, highly vapour-permeable roof membrane, available in three different colours.
- Resistant to tearing.
- Used for insulated and ventilated pitched roofs, also with full sarking as well as for frame houses.
- Available in the SYSTEM SK2.

ca. 170 g/m<sup>2</sup> | ca. 0,02 m | 1,5 m x 50 rm | 40 Rolls



## RFLEX

- Four-layer, highly vapour-permeable, metallized roof membrane.
- Highly reflective – reflects heat rays.
- Used for fasades as well as for insulated and ventilated pitched roofs, also with full sarking.
- Available in the SYSTEM SK2.

ca. 160 g/m<sup>2</sup> | ca. 0,02 m | 1,5 m x 50 rm | 40 Rolls



## VSTRONG

- Four-layer, highly vapour-permeable, reinforced with PE mesh.
- Extremely resistant to tearing.
- Used for insulated and ventilated pitched roofs, also with full sarking as well as for frame houses.
- Available in the SYSTEM SK2.

ca. 200 g/m<sup>2</sup> | ca. 0,02 m | 1,5 m x 50 rm | 40 Rolls



## XSTRONG

- Four-layer, highly vapour-permeable, watertight roof membrane.
- Extremely resistant to tearing.
- For insulated and ventilated pitched roofs.
- Suitable also for fully sarked roofs with a low slope.
- Recommended for frame houses too.
- Available in the SYSTEM SK2.

ca. 250 g/m<sup>2</sup> | ca. 0,04 m | 1,5 m x 30 rm | 40 Rolls

### › Construction of roof membranes

Eurovent® STRONG; Eurovent® VSTRONG; Eurovent® XSTRONG

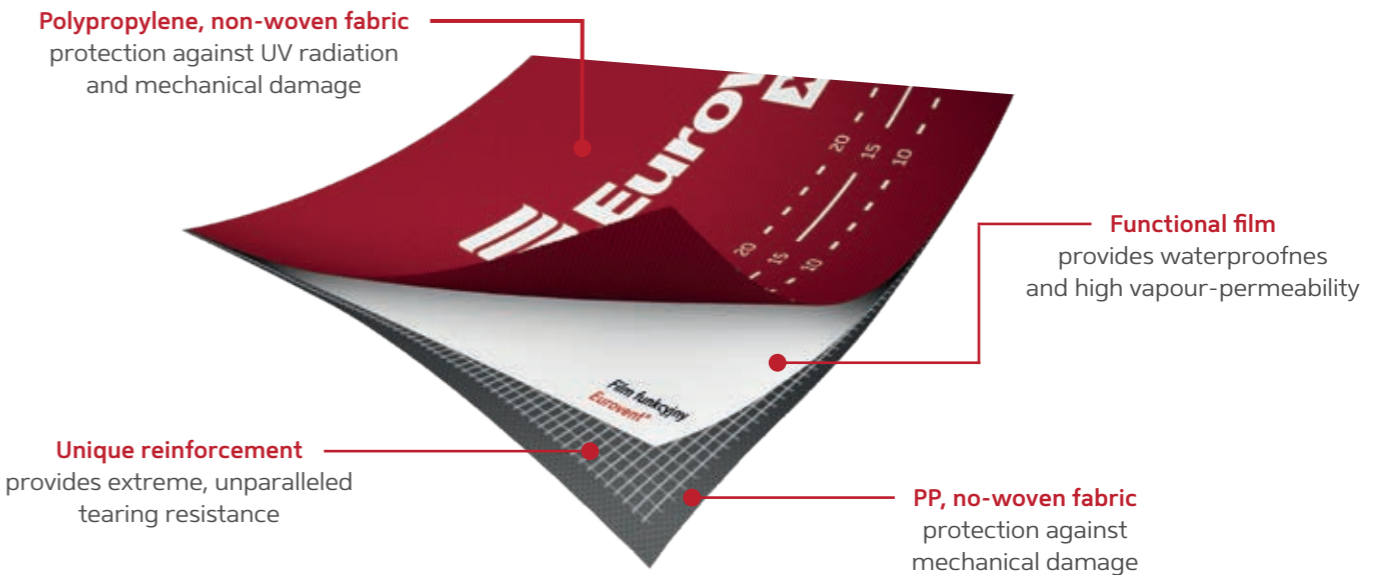

### › Application of roof membranes in the rafter sarked technique

- 1 Eurovent® XSTRONG
- 2 Eurovent® PUR
- 3 Sarking
- 4 Thermal insulation
- 5 Vapour barrier
- 6 Rafter
- 7 Batten & counter batten
- 8 Metal roof cover

### Recomended membranes:

- |             |           |            |
|-------------|-----------|------------|
| • CLASSIC   | • RFLEX   | • MAGNUM   |
| • MAXI      | • VSTRONG | • STRATOS  |
| • MAXI PLUS | • COMFORT | • BITUMI   |
| • STRONG    | • XSTRONG | • METALLIC |
| • SUPER     | • MONO    |            |

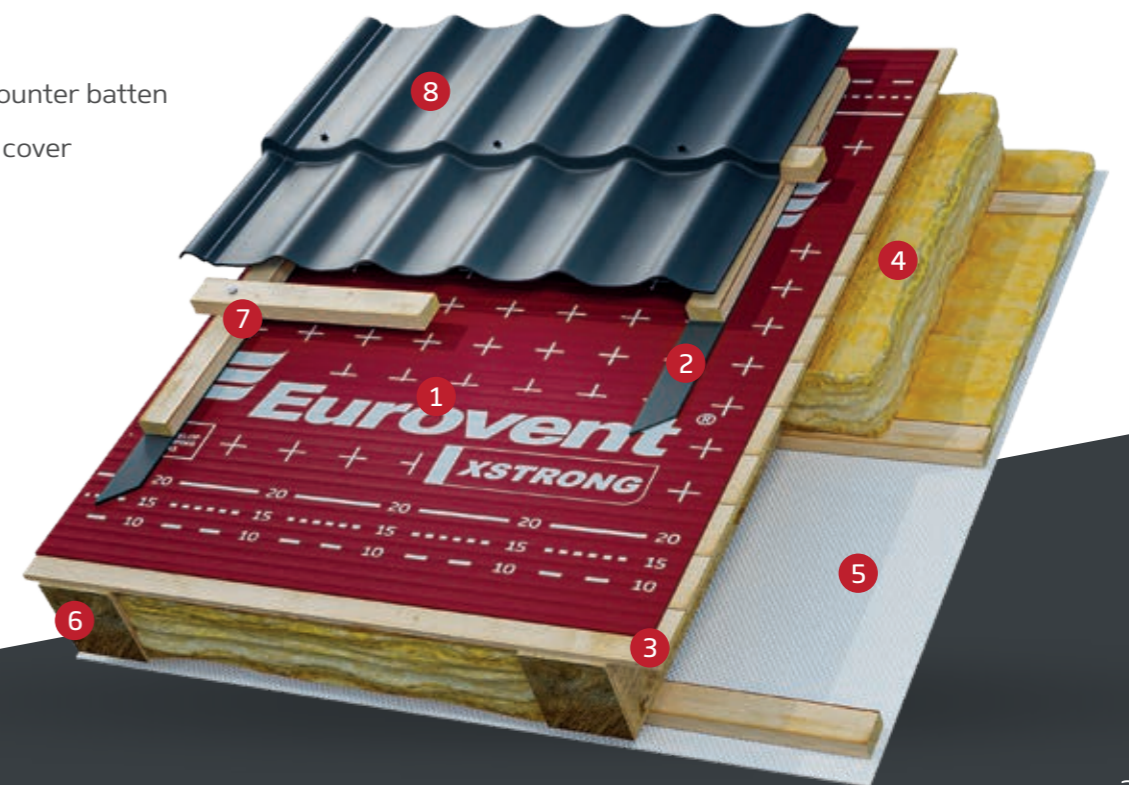





GREEN  
BLACK

## SUPER SA

- Three layer self-adhesive airtight and waether resistant housewrap and roof membrane.
- It is intended for use as a pitched roof underlay and housewrap in facade timbre frame, CLT, concrete and prefabricated constructions.
- For temporary protection for intermediate ceilings and floors on multi-storey CLT or timber-frame buildings during the construction period.



ca. 230 g/m<sup>2</sup>  
ca. 270 g/m<sup>2</sup>



ca. 0,17 m  
ca. 0,19 m



1,5 m x 30 rm



40 rolls

## SYSTEM SA

membrane with self adhering layer

The SA system is a self-adhering glue coating applied on the entire membrane surface. The membrane is specifically designed for self-adhering to a prepared substrate and provides a high-performance watertight and airtight barrier.

### Advantages:

- High wind and moisture protection.
- Perfect adhesion to walls and big surfaces.
- Fast and easy installation.
- Tear resistant.

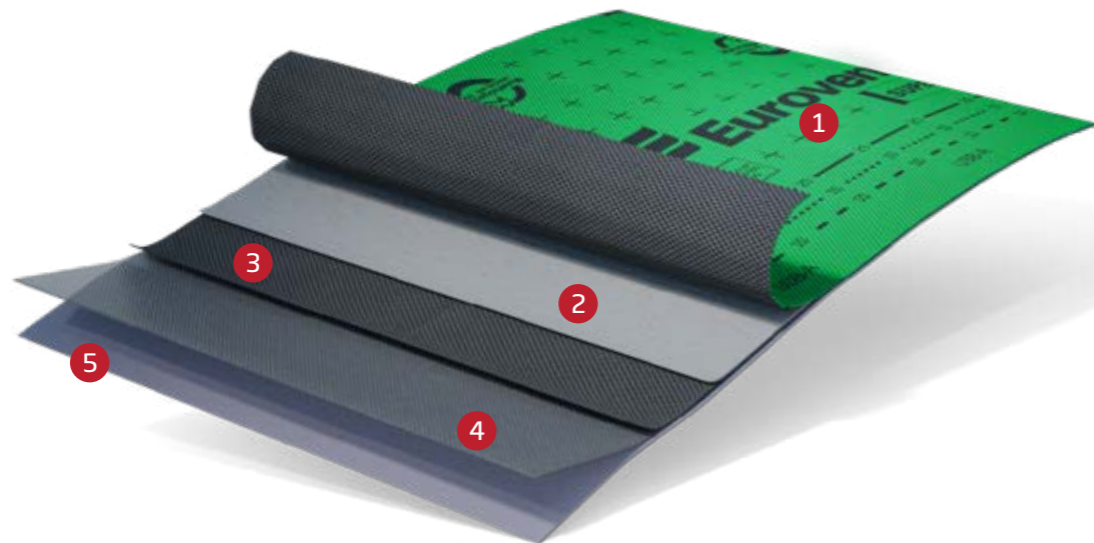

### › Eurovent® SUPER SA - composition

- 1 PP non-woven fabric
- 2 Functional film
- 3 PP non-woven fabric
- 4 Acrylic adhesive layer
- 5 Protective layer

### › Eurovent® SUPER SA - roof insulation

- 1 Eurovent® SUPER SA
- 2 Eurovent® CLIMA
- 3 Plasterboard
- 4 Batten
- 5 Roof tile
- 6 Thermal insulation
- 7 Rafter
- 8 OSB board



### › Eurovent® SUPER SA - timber frame wall insulation

- 1 Eurovent® SUPER SA
- 2 Eurovent® EPDM PRO
- 3 Eurovent® AKTIV FR
- 4 Plasterboard
- 5 Thermal insulation
- 6 OSB board
- 7 Cladding





# SYSTEM SK2

## Membrane with two self-adhesive tapes.

The SK2 system is an innovative system of joining the laps by the use of two self-adhesive tapes.

The SK2 system enables easier installation as well as guarantees proper overlaps adhesion. Effective membranes joining is possible only in case of using two overlapping tapes, which join membranes durably in all atmospheric conditions, e.g. at the time of high humidity, rain, windy weather, low temperatures and by extremely dirty membrane surface.

The SK2 system prevents against rain blown beneath the membrane, as well as thermal insulation rising damp and heat loss as a result of cooling the thermal insulation by cold air.

### Products available in the SYSTEM SK2:

#### Roof membranes:

BASIC  
CLASSIC  
HOME PRO  
MAXI  
MAXI PLUS  
STRONG  
SUPER  
RFLEX  
VSTRONG  
XSTRONG  
COMFORT  
STRATOS  
MONO  
MAGNUM  
BITUMI

#### Wind barrier membranes:

WALL PROTECT  
WALL PROTECT 3  
WALL PROTECT FR  
FASSADE

#### Vapour barrier membranes:

CLIMA  
CLIMA X  
AKTIV  
AKTIV 3  
AKTIV ALU  
AKTIV FR

### Advantages of the SYSTEM SK2:

- Adhesion possible at all atmospheric conditions
- Effective roof insulation
- Protection against wind and moisture
- Thermal energy saving



### › Eurovent® SYSTEM SK2

- 1 Eurovent® SUPER
- 2 Eurovent® Fassade
- 3 Eurovent® SYSTEM SK2
- 4 Full sheathing
- 5 Facade
- 7 Thermal insulation



## COMFORT

- Three-layer, highly vapour-permeable, watertight roof membrane.
- Extremely resistant to tearing.
- For insulated and ventilated pitched roofs.
- Suitable also for fully sarked roofs with a low slope.
- Available in the SYSTEM SK2.

ca. 220 g/m<sup>2</sup> | 
 ca. 0,03 m | 
 1,5 m x 50 rm | 
 40 Rolls



## STRATOS

- Vapour-permeable roof membrane of an increased UV resistance.
- Suitable also for roofs with a low slope.
- Also for fully sarked roofs.
- Increased flammability class - B-s1, d0.
- Available in the SYSTEM SK2.

ca. 210 g/m<sup>2</sup> | 
 ca. 0,02 m | 
 1,5 m x 50 rm | 
 40 Rolls



## MONO

- Three-layer, highly vapour-permeable, roof membrane, equipped with a special monolithic film.
- Used for sloping, insulated and ventilated roofs.
- Suitable also for roofs with a low slope.
- Also for fully sarked roofs..
- Available in the SYSTEM SK2.

ca. 260 g/m<sup>2</sup> | 
 < 0,3 m | 
 1,5 m x 50 rm | 
 25 Rolls



## MAGNUM

- Anti-condensation, vapour-permeable roof membrane.
- Resistant to tearing and watertight.
- For fully sarked roofs with a low slope.
- Suitable for being used in the construction of frame houses.
- Available in the SYSTEM SK2.



ca. 210 g/m<sup>2</sup> | 
 ca. 0,15 m | 
 1,5 m x 50 rm | 
 40 Rolls





## BITUMI



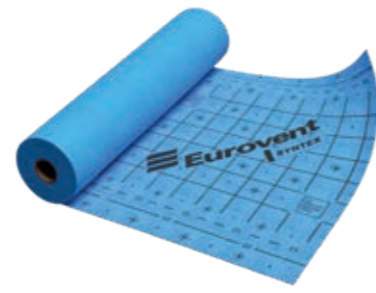

- Three-layer, bitumen roof membrane.
- Used for sloping, insulated and ventilated roofs, covered with bituminous shingle and slate.
- Suitable for fully sarked roofs and for frame houses too.
- Available in the SYSTEM SK2.

 ca. 450 g/m<sup>2</sup> | 
  ca. 50 m | 
  1 m x 30 rm | 
  24 Rolls



## SYNTEX



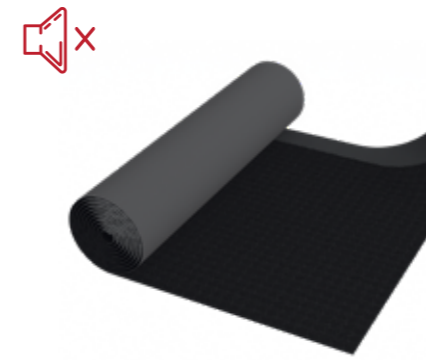

- Four-layer synthetic roof underlay.
- Designed for ventilated sloping roofs with full sheathing only.
- Recommended for application with shingles as well as slates.
- Available in the SYSTEM SK2.

 ca. 170 g/m<sup>2</sup> | 
  ca. 40 m | 
  1,1 m x 50 rm | 
  40 Rolls



## METALLIC



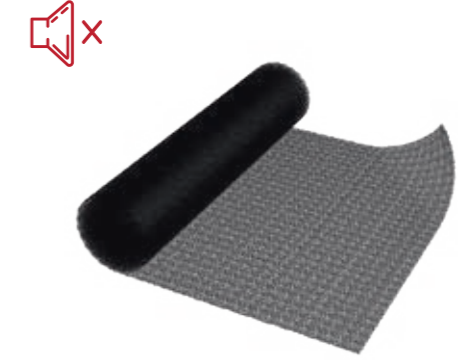

- Three-layer roof membrane with multifilament.
- Used for sloping roofs, elevations and frame constructions.
- Recommended under metal coverings and elevations.
- Drains condensate.
- Available in the SYSTEM SK.
- Acoustic isolation, reduces noise to about 25 dB.

 ca. 450 g/m<sup>2</sup> | 
  ca. 0,02 m | 
  1,5 m x 25 rm | 
  8 Rolls



## MATT

- Single-layer separation mat.
- Used for sloping, insulated and ventilated roofs.
- Recommended under metal coverings and elevations.
- Drains condensate.
- Acoustic isolation, reduces noise to about 25 dB.

 ca. 300 g/m<sup>2</sup> | 
  ≥ 7,5 mm | 
  1,4 m x 25 rm | 
  9 Rolls

### › Eurovent® SYNTEX

- 1 Eurovent® SYNTEX
- 2 Eurovent® HOME PRO
- 3 Eurovent® PUR
- 4 Thermal insulation
- 5 Rafter
- 6 OSB board
- 7 Bituminous shingle



### › Eurovent® METALLIC

- 1 Eurovent® METALLIC
- 2 Full sarking
- 3 Thermal insulation
- 4 Rafter
- 5 Flat sheet metal

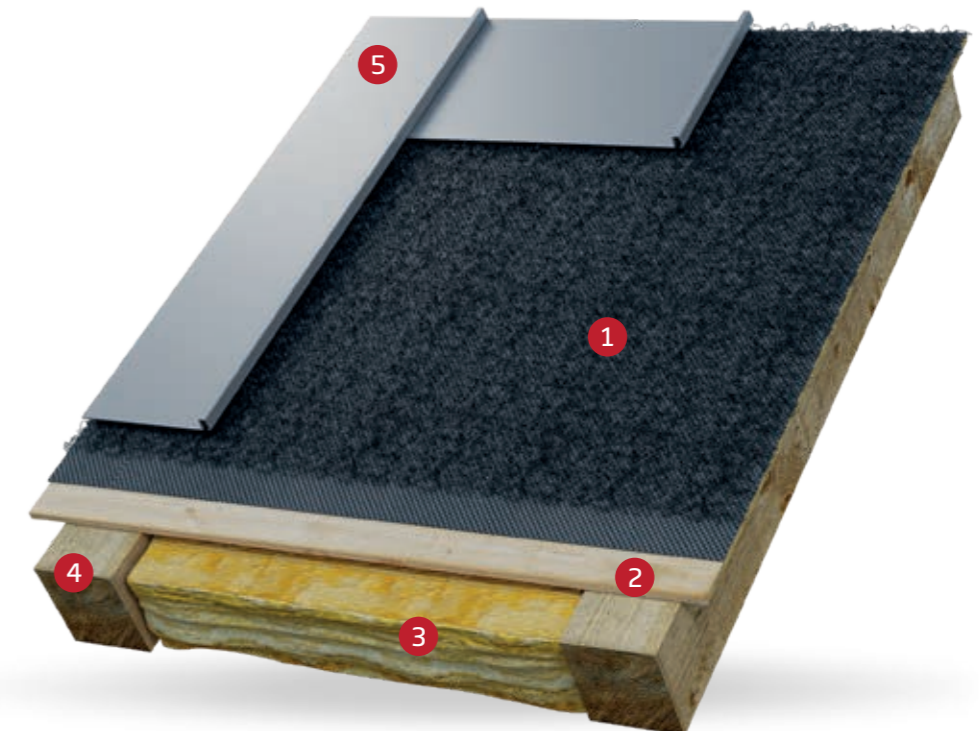





› Application roof membranes under roofs covered with roof slate, bituminous or wooden shingle

- 1 Eurovent® BITUMI
- 2 Eurovent® SYSTEM SK2
- 3 Bituminous shingle
- 4 Rafter
- 5 OSB board

Recomended membranes:

- BITUMI
- MAGNUM

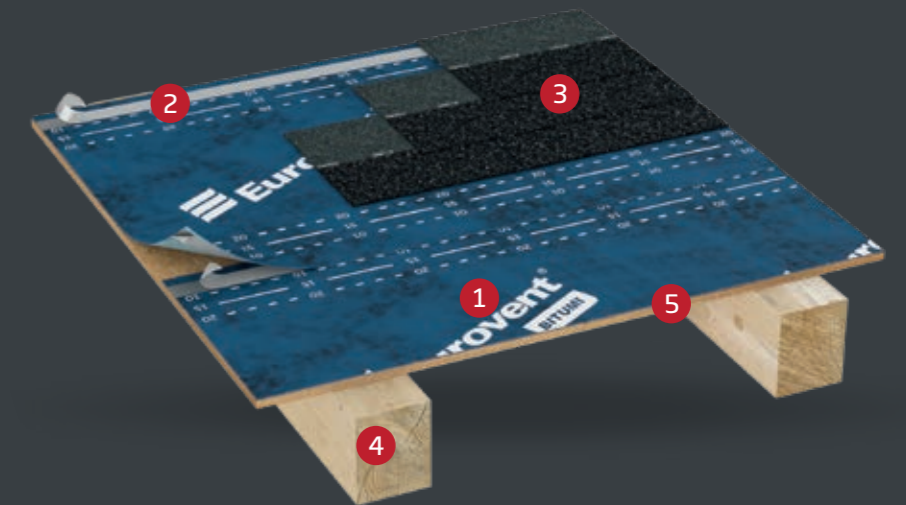

› Application roof membranes under roofs covered with flat sheet metal finished on a standing seam

- 1 Eurovent® METALLIC
- 2 Sarking
- 3 Rafter
- 4 Thermal insulation
- 5 Vapour barrier

Recomended membranes:

- METALLIC
- MATT

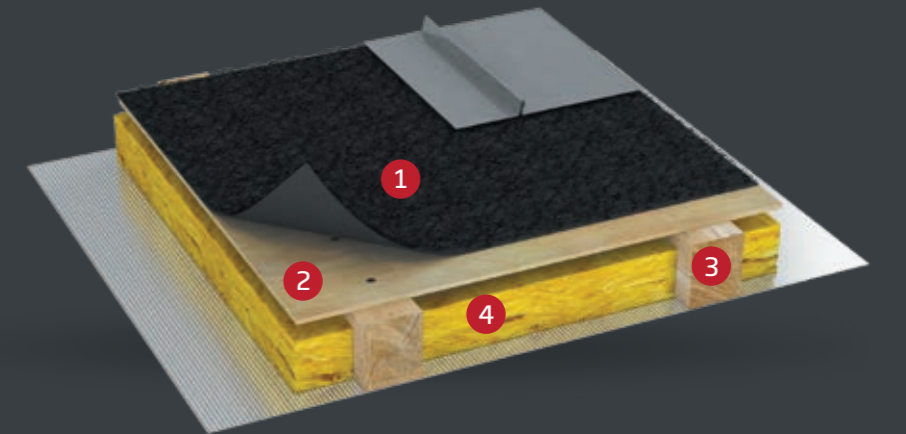

› Application roof membranes on roofs with a low angle

- 1 Eurovent® STRATOS
- 2 Sarking
- 3 Thermal insulation
- 4 Rafter
- 5 Vapour barrier
- 6 Batten

Recomended membranes:

- STRATOS
- XSTRONG

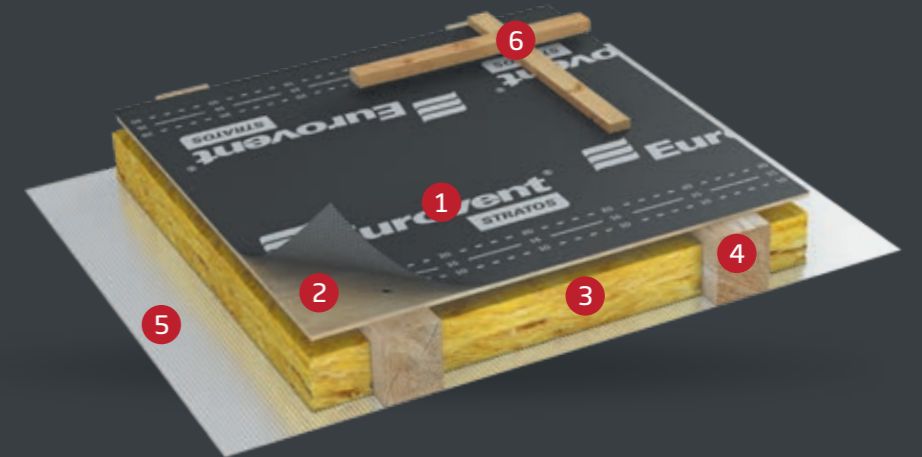





## Eurovent<sup>®</sup> System Guarantee

The Eurovent system has been covered by the products durability and functionality guarantee from 10 to 15 years, in dependence on the use range. Due to the high quality of production, we are ready to offer you a system of products that takes care of a positive climate and ensures energy saving in your house.

# 10 YEARS WARRANTY

### 10-YEARS SYSTEM GUARANTEE

is valid in case of the following products use:

- The Eurovent<sup>®</sup> roof membranes
- The Eurovent<sup>®</sup> adhesive tapes or the SYSTEM SK2

# 15 YEARS WARRANTY

### 15-YEARS SYSTEM GUARANTEE

is valid in case of the following products use:

- The Eurovent<sup>®</sup> Roof membrane
- The Eurovent<sup>®</sup> Adhesive tapes or the SYSTEM SK2
- The Eurovent<sup>®</sup> Ridge tape
- The Eurovent<sup>®</sup> Chimney tape
- The Eurovent<sup>®</sup> Venting COMB
- The Eurovent<sup>®</sup> Eaves grate
- The Eurovent<sup>®</sup> Roof safety



# WATERTIGHTNESS

Watertightness is a material's ability to keep a water pressure affecting its surface. This is one of the most essential parameters that describes roof membrane's performance. The watertightness is achieved by the use of a special functional film that is built in the membrane as a middle most important membrane's layer.

Watertightness is important both at the time of constructing the roof as well as later on during the regular use of the building, as it protects the house and the thermal insulation against harmful water effect especially during the seasons of autumn and spring, when big quantities of condensed water vapour appear under roof covering most often, then it drops down on a roof membrane's surface.

In case of any roof covering damages, watertightness ensures temporary protection for the thermal insulation as well as the protection of the roof construction against rising damp. It is highly important of a membrane to ensure constantly high resistance to a water pressure despite the aging process.

The DIN Standard states that a roof membrane is considered to be watertight if the parameter is on the 1,5 m level of water column [H<sub>2</sub>O]. Therefore, it is significant that the initial watertightness value on a roof membrane is on the level bigger than 2-3 m of a water column, as the value constitutes a kind of protection against the progressive aging process. In the conditions of a very intensive and long-time aging, the decrease of a roof membrane parameters by half will result in keeping the watertightness level in accordance with its norm.

## ATTENTION:

- Meter is a unit H<sub>2</sub>O [m].
- Watertightness according to the DIN Standard is min. 1,5 m H<sub>2</sub>O.



## › Vapour barrier membranes

Active membranes are used as a vapour barrier layer for roofs and walls in case of residential, commercial construction as well as specialized, innovative architectural projects.





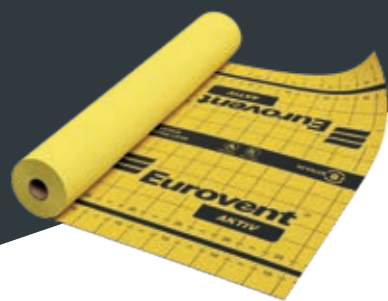

## AKTIV

- Two-layer, active vapour control membrane.
- Prevents vapour condensation.
- For pitched roofs and wall constructions.
- Available in the SYSTEM SK2.

ca. 90 g/m <sup>2</sup>	ca. 8 m	1,5 m x 50 rm 3,0 m x 50 rm*	50 Rolls

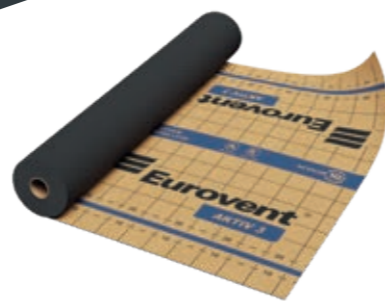

## AKTIV 3

- Three-layer active vapour control membrane.
- Prevents vapour condensation.
- For pitched roofs, wall constructions and framed houses.
- Available in the SYSTEM SK2.

ca. 140 g/m <sup>2</sup> ca. 160 g/m <sup>2</sup>	ca. 10 m	1,5 m x 50 rm	50 Rolls



## CLIMA

- Active vapour control membrane, resistant to tearing.
- Prevents vapour condensation.
- For pitched roofs, wall constructions and framed houses.
- Available in the SYSTEM SK2.

ca. 85 g/m <sup>2</sup>	ca. 2-16 m	1,5 m x 50 rm 3,0 m x 50 rm*	50 Rolls



## CLIMA X

- Active vapour control membrane, reinforced with PE mesh.
- Highly resistant to tearing.
- Prevents vapour condensation.
- For pitched roofs and wall constructions.
- Available in the SYSTEM SK2.

ca. 115 g/m <sup>2</sup>	ca. 2-16 m	1,5 m x 50 rm	50 Rolls



### › Eurovent® AKTIV 3 in attic insulation

- 1 Eurovent® AKTIV 3
- 2 Eurovent® UNISAN
- 3 Thermal insulation
- 4 Plasterboard
- 5 Rafter
- 6 Roof tiles

### › Eurovent® CLIMA X on timber frame wall

- 1 Eurovent® CLIMA X
- 2 Eurovent® UNISAN
- 3 Cellulose insulation
- 4 Plasterboard
- 5 Construction
- 6 OSB board
- 7 Eurovent® WALL PROTECT 3

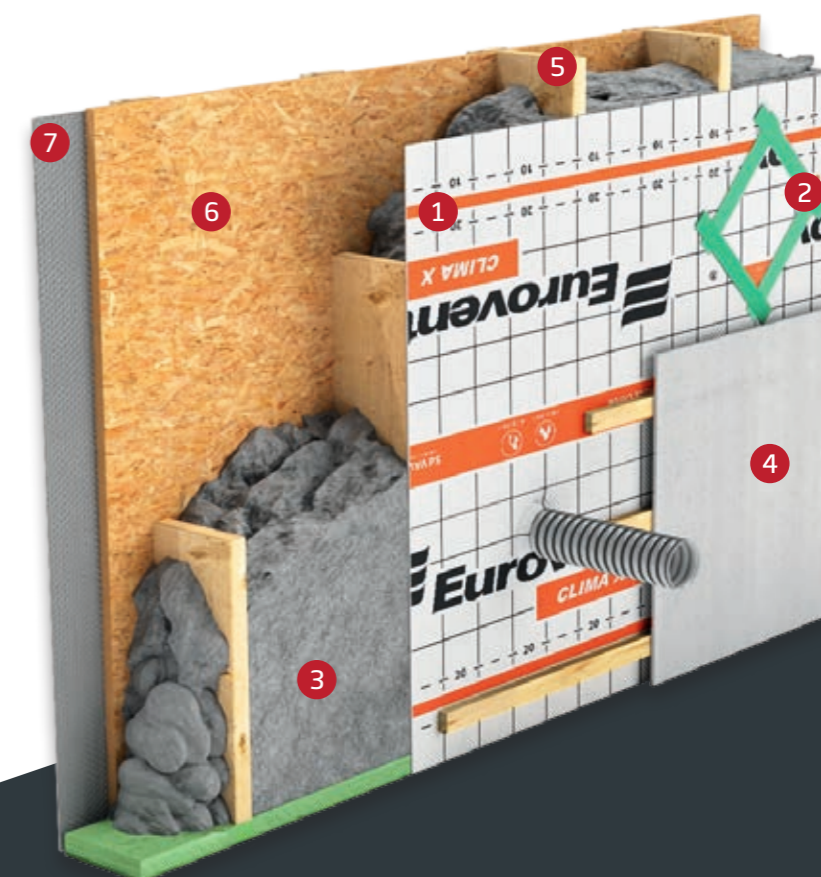





## AKTIV FR

- Three-layer aluminum active vapour control membrane. Reflects of heat rays.
- Prevents vapour condensation.
- Suitable for sloping roofs, frame houses and specialized wall constructions
- Increased flammability class - B-s1, d0\*\*.
- Available in the SYSTEM SK2.



ca. 150 g/m<sup>2</sup> | ca. 150 m | 1,5 m x 50 cm | 40 Rolls



## AKTIV ALU

- Three-layer metallized active vapour control membrane. Reflects of heat rays.
- Prevents vapour condensation.
- For sloping roofs and wall constructions.
- Available in the SYSTEM SK2.



ca. 110 g/m<sup>2</sup> | ca. 40 m | 1,5 m x 50 cm | 50 Rolls

### › Eurovent® AKTIV FR in the open elevation system

- 1 Eurovent® AKTIV FR
- 2 Eurovent® FASSADE
- 3 Facade panels
- 4 Thermal insulation
- 5 Wall
- 6 Construction

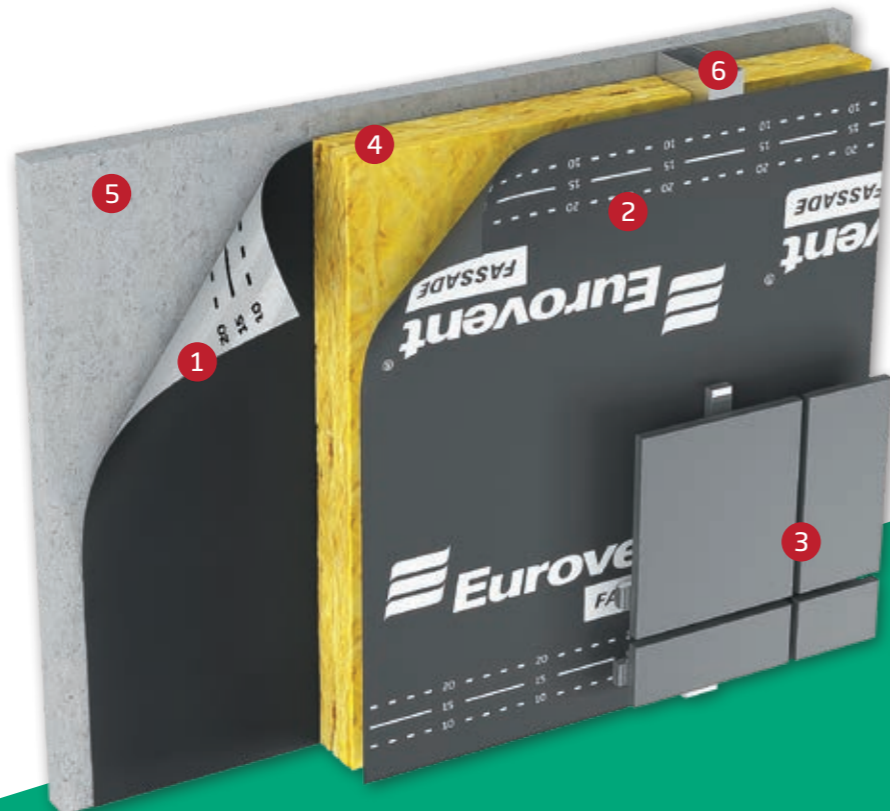

### Eurovent® AKTIV FR

It is used as a vapour-barrier layer in new buildings, especially in modern facade systems. Suitable also for sloping roofs, frame houses and specialised wall constructions. The product fulfils high legitimate regulations concerning flammability in facade constructions.

### › Eurovent® AKTIV FR in frame construction

- 1 Eurovent® AKTIV FR
- 2 Eurovent® WALL PROTECT 3
- 3 Eurovent® TOPBAND
- 4 Eurovent® MAUER PVC
- 5 Eurovent® BAU
- 6 Eurovent® DB
- 7 Floor panel
- 8 Concrete floor
- 9 Thermal insulation
- 10 Gravel
- 11 Foundation

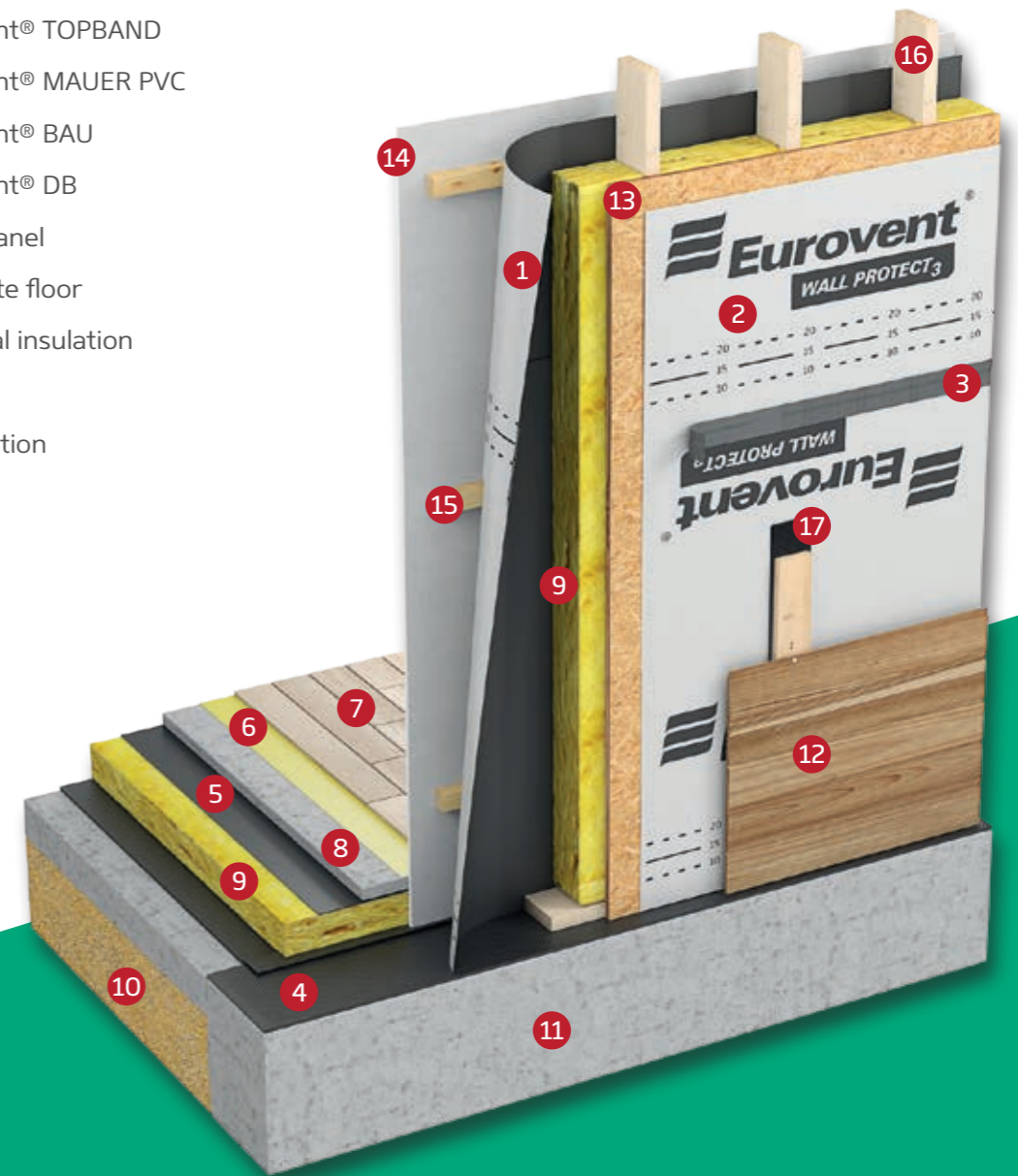

- 12 Elevation
- 13 OSB board
- 14 Plasterboard
- 15 GK board construction
- 16 Wall construction
- 17 Eurovent® EPDM PRO

\*\* Supported with substrate.





# VAPOUR DIFUSIONAL RESISTANCE

Water vapour diffusion resistance factor ( $S_d$ ) is a diffusional equivalent of the air layer thickness that creates a barrier for the water vapour diffusion.  $S_d$  is given in meters. The bigger  $S_d$  is the bigger diffusional resistance is and vice versa.  $S_d$  40 m means that particular material creates a barrier for the diffusion of the water vapour comparable to the 40m thick air layer.  $S_d$  is a nonrelative value, not dependable from temperature, pressure, or humidity.

That means that the  $S_d$  value for particular material is constant and this enables to verify its water vapour permeability or its vapour barrier performance.

**ATTENTION:**

- Metr [m] is the  $S_d$  unit.
- $S_d$  is an absolute value.

Division of membranes and vapour-barrier foils according to the  $S_d$  factor:

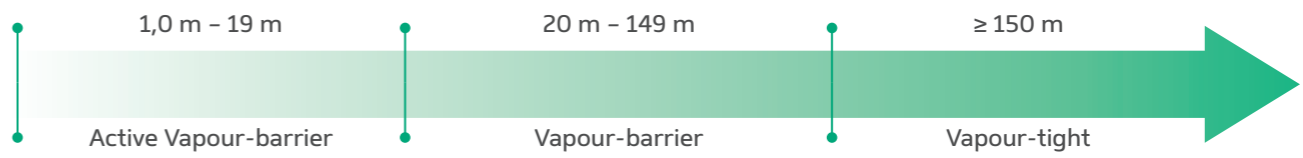



## Eurovent® CLIMA

It is used as vapour control layer protecting an attic – regulation of an attic moisture level. Moreover, it is suitable in renovation of attic thermomodernisation from the outer side on sarked and non-sarked roofs, as well as in case of roofs which require renovation or additional insulation and such a renovation is not possible to carry out from the inside of a building.

### › Regulation of an attic moisture level

- 1 Eurovent® CLIMA
- 2 Eurovent® UNISAN
- 3 Plasterboard
- 4 Thermal insulation
- 5 Rafter
- 6 Roof tiles



### › Renovation of sarked roof

- 1 Eurovent® SUPER
- 2 Eurovent® CLIMA
- 3 Eurovent® PUR
- 4 Eurovent® UNISAN
- 5 Batten & counter batten
- 6 Thermal insulation
- 7 Full sarking
- 8 Additional rafter
- 9 Rafter



### › Renovation of old roof

- 1 Eurovent® SUPER
- 2 Eurovent® CLIMA
- 3 Eurovent® PUR
- 4 Batten
- 5 Thermal insulation
- 6 Full sarking
- 7 Rafter

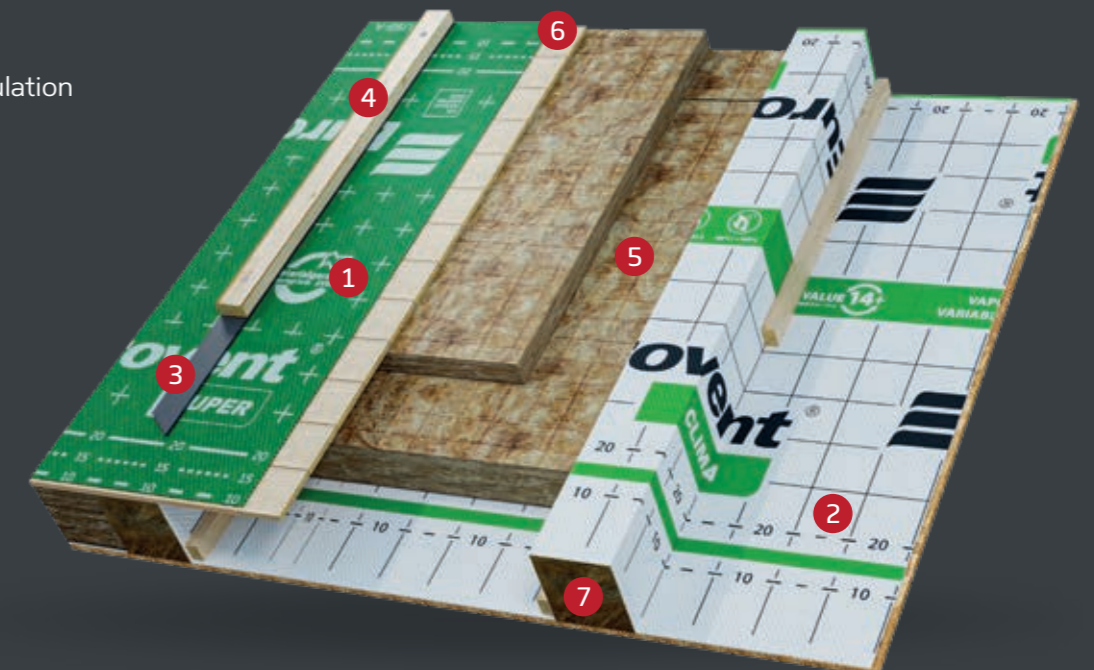



# FIRE RESISTANCE

The harmonized European Fire Standards are a set of test standards that have been accepted by all countries within the European Economic Community. This allows manufacturers to produce or import products that have been tested to a common standard without the need to test in each member state. Testing to these standards is now accepted in all EEC countries.

## Reaction to fire

If a fire is able to find sufficient flammable materials it will quickly spread through an area. It is therefore crucial to use materials of limited combustibility on key surfaces within a room, such as ceilings and walls.

The use of such materials can dramatically reduce the speed flames spread through an area as well as minimize their contribution to the fire.

The European standard EN 13501-1: Reaction to Fire provides a number of performance criteria to measure the fire characteristics of building products. These cover spread of flame and contribution to fire as well the generation of smoke and the production of burning droplets. The table below provides an overview of the available classifications.

## The Declaration of Performance

„DoP“ is the main document that will normally be required by local authority officers to show that the intended ceiling/ wall system will meet the specified performance level.

## Table legend:

- Not applicable
- Smoke and burning droplets
- No smoke and no burning droplets
- Smoke and no burning droplets
- Burning droplets without smoke

European class according to EN 13501-1

Additional requirements	A1	A2	B	C	D	E	F
-	○	-	-	-	-	○	○
s1 d0	-	●	●	●	●	-	-
s1 d1	-	●	●	●	-	-	-
s1 d2	-	●	●	●	●	-	-
s2 d0	-	●	●	●	●	-	-
s2 d2	-	-	-	-	●	-	-
s3 d0	-	●	-	●	●	-	-
s3,d2	-	●	●	●	●	-	-
d2	-	-	-	-	-	●	-

## The additional designations are:

### • Smoke

- s1 – little or no smoke generation;
- s2 – medium smoke generation;
- s3 – heavy smoke generation.

### • Burning droplets

- d0 – no droplets within 600 seconds;
- d1 – droplet form within 600 s but do not burn for more than 10 seconds;
- d2 – not as d0 or d1.

Country	Test standard	Classification
EC member states	EN 13501-1	A2 s1 d0; B s1 d0
Switzerland	Guide to fire regulations 1976	VI q.3 virtually non-combustible, smoke level low
USA	ASTM E 84-97 a	Class I





## AKTIV PRO

- Reflective vapour barrier made of pure aluminum foil on the top and bottom and high density layer with E glass filaments.
- Thanks to its high density fiber-glass layer the product assures both: effectiveness on heat transfers by conduction as well as thermal and acoustic comfort during summer and winter.
- Allows to efficiently insulate all walls with a maximum space saving -46% on the additional insulation thickness.
- The product possesses high reflectivity (95%).
- Non-combustible product Class A1 - according to the EN 13501. The product ensures security for assets and people during rescue teams operations.
- High insulating properties ( $\lambda = 0,028 \text{ W/mK}$ )
- Available in the SYSTEM SK



\* Information on indoor air emission levels of volatile substances, with a risk of toxicity by inhalation, on a class scale ranging from A+ (very low emissions) to C (high emissions).

### › Eurovent® AKTIV PRO Ceiling/Floor insulation

- 1 Eurovent® AKTIV PRO
- 2 Eurovent® SPECIAL N FR<sub>5000</sub>
- 3 Eurovent® FASSADE
- 4 Thermal insulation

- 5 Window
- 6 Floor
- 7 Ceiling
- 8 Ceiling construction
- 9 Ceiling tiles

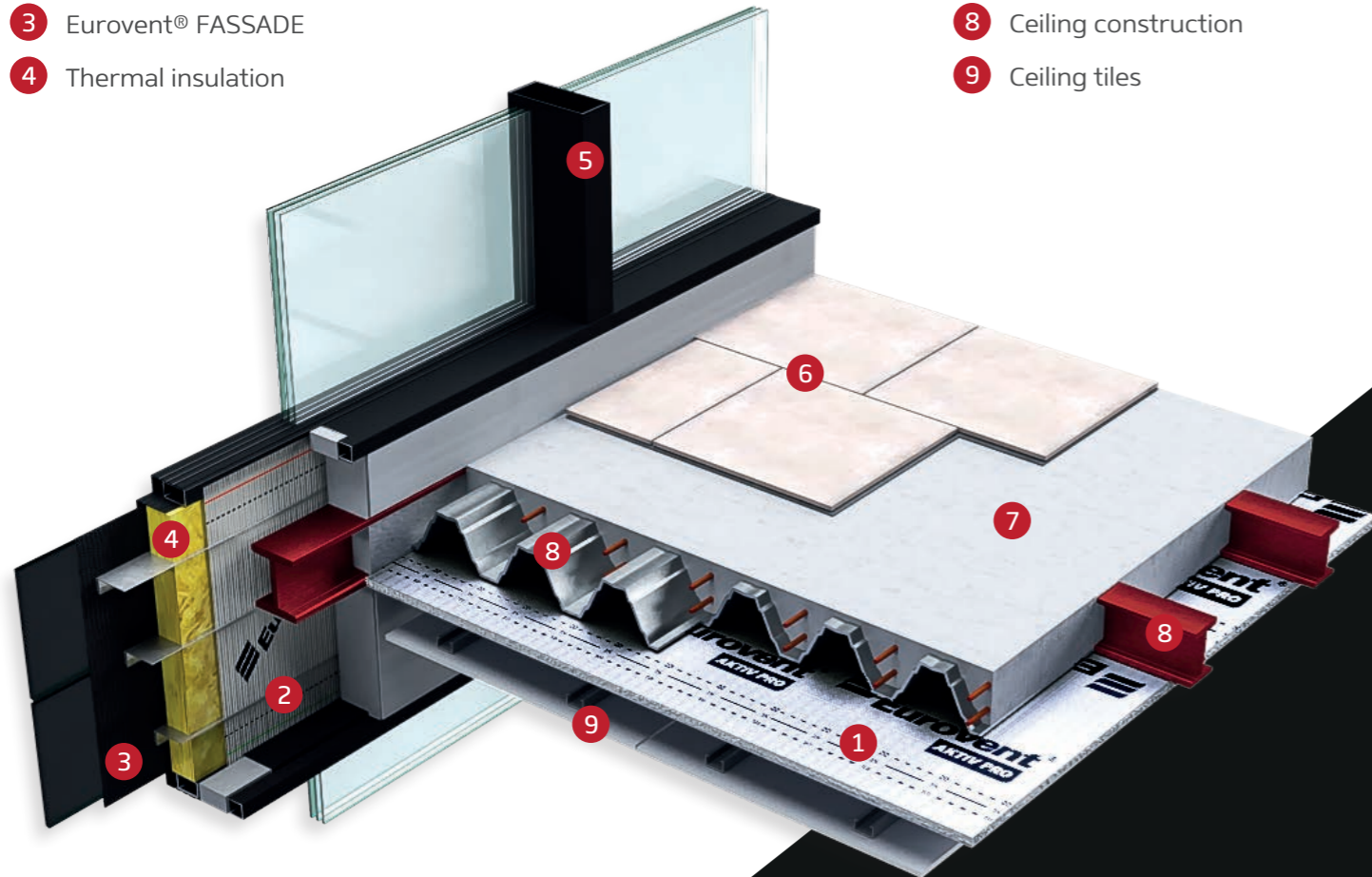

## Technical Data AKTIV PRO

Roll size	Mass per unit	Sd value	Sound reduction	Thermal resistance	Reaction to fire	Rolls per pallet
1,0 m x 25 rm 1,93 m x 15 rm	ca. 830 g/m <sup>2</sup>	ca. 4000 m	-13 dB (product alone)	1,55 m <sup>2</sup> .K/W	A1 non - combustible	12 rolls

PARAMETER	NORM	VALUE	UNIT
Vapour-permeability	-	ca. 20000	MNs/g
Thermal conductivity ( $\lambda$ )	-	0,028	W/mK
Water-tightness	EN 1928	W1	-
Thickness	-	6	mm
Emissivity/ Reflectivity	EN 15976	5/95	%

\* UV stabilization even up to 4 months according to artificial ageing performed in the laboratory related to the conditions of average sun exposure for the climate in Central Europe.





# WATER VAPOUR CONDENSATION

Condensation is a process where the physical state of the water vapour contained in the air changes from the gas into drops of water appearing on the surfaces that are in touch with the air. Normally the air has particular humidity which means it includes some quantities of the water vapour. When the conditions change - either the temperature goes down or the humidity goes up or both of the conditions change - this leads into the condensation.

The drops appear. In the buildings there is a matter of where the dew point is located - the point in which the temperature, air humidity and its pressure enable water vapour condensation. In order to dislocate the dew point out of the building area it is highly recommended to lift up the temperature in the building or/ and to prevent the increase of the humidity by sufficient ventilation. It is very essential especially in the new buildings that have been closed (doors & windows) but where still finishing works are being performed (wet technology like concrete, mortar, paint etc).

Seasons such as autumn, winter, spring decrease a building air temperature in a natural way, what enhances the risk of condensation appearance. In critical situations it is highly recommended not only to increase the temperature of an inside but also to intensify the ventilation through open windows and doors, what unfortunately generates significant heating costs.

Therefore, it is recommended to conduct finishing works in closed buildings during warm seasons, when air temperature counteracts the condensation in a natural way. In such conditions opening windows and doors in a building increases air ventilation, continues evaporation of humidity contained in construction substrates while drying them with out the need of artificial temperature rising of an inside.

Moreover, in case of a roof and an attic, independently on the above mentioned factors, proper choice and installation of waterproofing and ventilating materials has to be assured in order to ensure right tightness and ventilation in the building as well as good and effective functionality, far from condensation problem. Membranes and roof foils, ventilating and protecting elements of a ridge, eaves can be applied here and various, professional sealing tapes for each of the areas.

## ATTENTION:

- Avoid carrying out wet works in a building in the winter season
- Pay attention at proper ventilation performance in a building, especially in case of renovated and converted rooms.



## › Wind barrier membranes





Wind barrier membranes are used for the protection of facades against wind, rain and moisture. They are applied in case of facade insulation systems, metal facades, frame construction as well as in case of log houses too.





## WALL PROTECT





- One-layer, highly vapour-permeable windproof membrane.
- Used for closed elevations.
- Available in the SYSTEM SK2.
- Available also without prints\*.

 ca. 100 g/m<sup>2</sup> | 
  ca. 0,02 m | 
  1,5 m x 50 rm | 
  3,0 m x 50 rm | 50 Rolls



## WALL PROTECT 3





- Three-layer, watertight, highly vapour-permeable windproof membrane.
- UV resistant.
- Used for closed elevations.
- Available in the SYSTEM SK2.
- Available also without prints\*.

 ca. 90 g/m<sup>2</sup> | 
  ca. 0,02 m | 
  1,5 m x 50 rm | 
  3,0 m x 50 rm | 50 Rolls



## WALL PROTECT FR





- Three-layer, metalized, highly vapour-permeable windproof membrane. Reflects of heat rays.
- Extremely UV resistant.
- Used for closed and open facades.
- Available in the SYSTEM SK2.
- Available also without prints\*.
- Increased flammability class - B-s1, d0\*\*.

 ca. 150 g/m<sup>2</sup> | 
  ca. 0,02 m | 
  1,5 m x 50 rm | 
  3,0 m x 50 rm | 50 Rolls



## FASSADE





- Two-layer, watertight, highly vapour-permeable windproof membrane.
- Extremely UV resistant
- Used for closed and open facades.
- Available in the SYSTEM SK2.
- Available also without prints\*.
- Increased flammability class - B-s1, d0.

 ca. 210 g/m<sup>2</sup> | 
  ca. 0,02 m | 
  1,5 m x 50 rm | 
  40 Rolls



## HOME PRO

- Three layer airtight, water vapour gihly permeable premium housewrap an roofing underlay.
- Used as the underlay on the slope roof and as the house wrap on the facade, in the umber, brick, concrete and prefabricated construction, timber framing, CLT, passive houses and fully sheating.
- Available in the SYSTEM SK2.

 ca. 135 g/m<sup>2</sup> | 
  ca. 0,02 m | 
  1,5 m x 50 rm | 
  3,0 m x 50 rm\* | 50 Rolls

### › Eurovent® WALL PROTECT FR in the closed elevation

- 1 Eurovent® WALL PROTECT FR
- 2 Eurovent® AKTIV FR
- 3 Thermal insulation
- 4 Facade construction
- 5 Facade
- 6 Wall







## FIBER PRO

- Vapour-permeable wind barrier.
- Made of pure aluminum foil reinforced with glass fibers, waterproof film, high density layer with E glass filaments and breather pure aluminum foil.
- Product provides both weather barrier and insulation functions. Ideal for refurbishment or new build projects.
- Non combustible Class A2 - s1, d0 - according to the EN 13501
- Tear resistant, airtight ideal for building envelope, eliminates thermal bridges.
- High insulating properties ( $\lambda = 0,029$  W/mK)
- Thermal comfort during summer and winter (reflective insulation) - 95% reflectivity
- Available in the SYSTEM SK.



\* Information on indoor air emission levels of volatile substances, with a risk of toxicity by inhalation, on a class scale ranging from A+ (very low emissions) to C (high emissions).



**Non  
combustible**



**Thermal resistance**  
1,7 m<sup>2</sup>.K/W (U=0,59 W/m<sup>2</sup>.K)



**Sound reduction**  
-16 dB (product alone)



### › Composition of FIBER PRO

- 1 Aluminum reflective
- 2 Functional film
- 3 Fiberglass
- 4 Aluminum

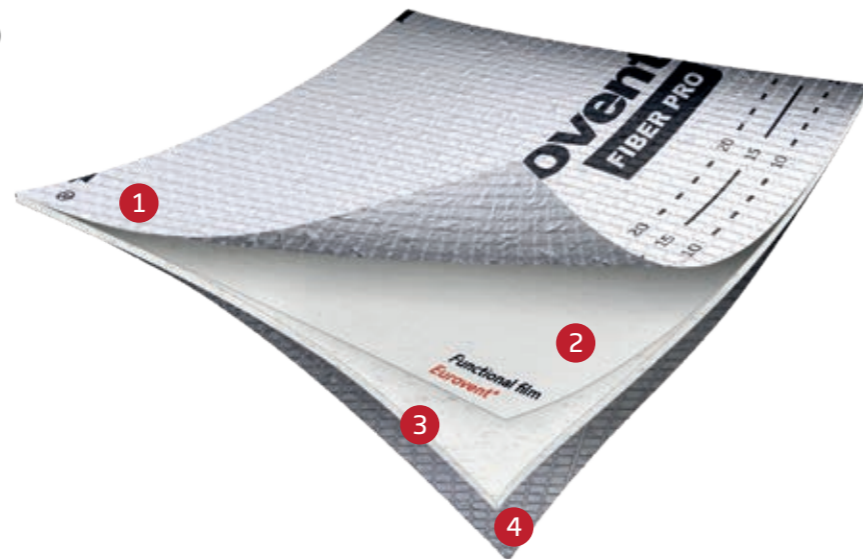

### Technical Data FIBER PRO

Roll size	Mass per unit	Sd value	Sound reduction	Thermal resistance	Reaction to fire	Rolls per pallet
1,12 m x 18 rm	ca. 1388 g/m <sup>2</sup>	ca. 0,05 m	-16 dB (product alone)	1,7 m <sup>2</sup> .K/W	A2-s1, d0 non-combustible	12 rolls

PARAMETER	NORM	VALUE	UNIT
Vapour-permeability	-	ca. 0,25	MNs/g
Thermal conductivity ( $\lambda$ )	-	0,029	W/mK
Water-tightness	EN 1928	W1	-
Thickness		8	mm
Emissivity/ Reflectivity	EN 15976	5/95	%
Elongation MD/CD	EN 12311-1	$\geq 6 (+/-2) / \geq 4 (+/-2)$	%
Tensile strength MD	EN 12311-1	630 (+/-70)	N/50 mm
Tensile strength CD	EN 12311-1	630 (+/-70)	N/50 mm
Tearing resistance MD	EN 12310-1	275 (+/-50)	N
Tearing resistance CD	EN 12310-1	280 (+/-50)	N

\* UV stabilization even up to 4 months according to artificial ageing performed in the laboratory related to the conditions of average sun exposure for the climate in Central Europe.

### › Eurovent® FIBER PRO facade cladding system

- 1 Eurovent® FIBER PRO
- 2 Eurovent® SPECIAL N FR<sub>5000</sub>
- 3 Plasterboard
- 4 Wall construction
- 5 Thermal insulation
- 6 Facade construction
- 7 Facade cladding





## Wind barrier membranes Eurovent®

They are used as walls insulation against wind, rain and moisture in the ventilated and non-ventilated elevation systems. Moreover, they are suitable as well in frame constructions, log houses, in residential buildings and industrial halls construction.

### › Eurovent® FASSADE in open joint facade

- |                      |                     |
|----------------------|---------------------|
| 1 Eurovent® FASSADE  | 5 OSB board         |
| 2 Eurovent® EPDM PRO | 6 Construction      |
| 3 Facade             | 7 Eurovent® AKTIV 3 |
| 4 Thermal insulation | 8 Plasterboard      |

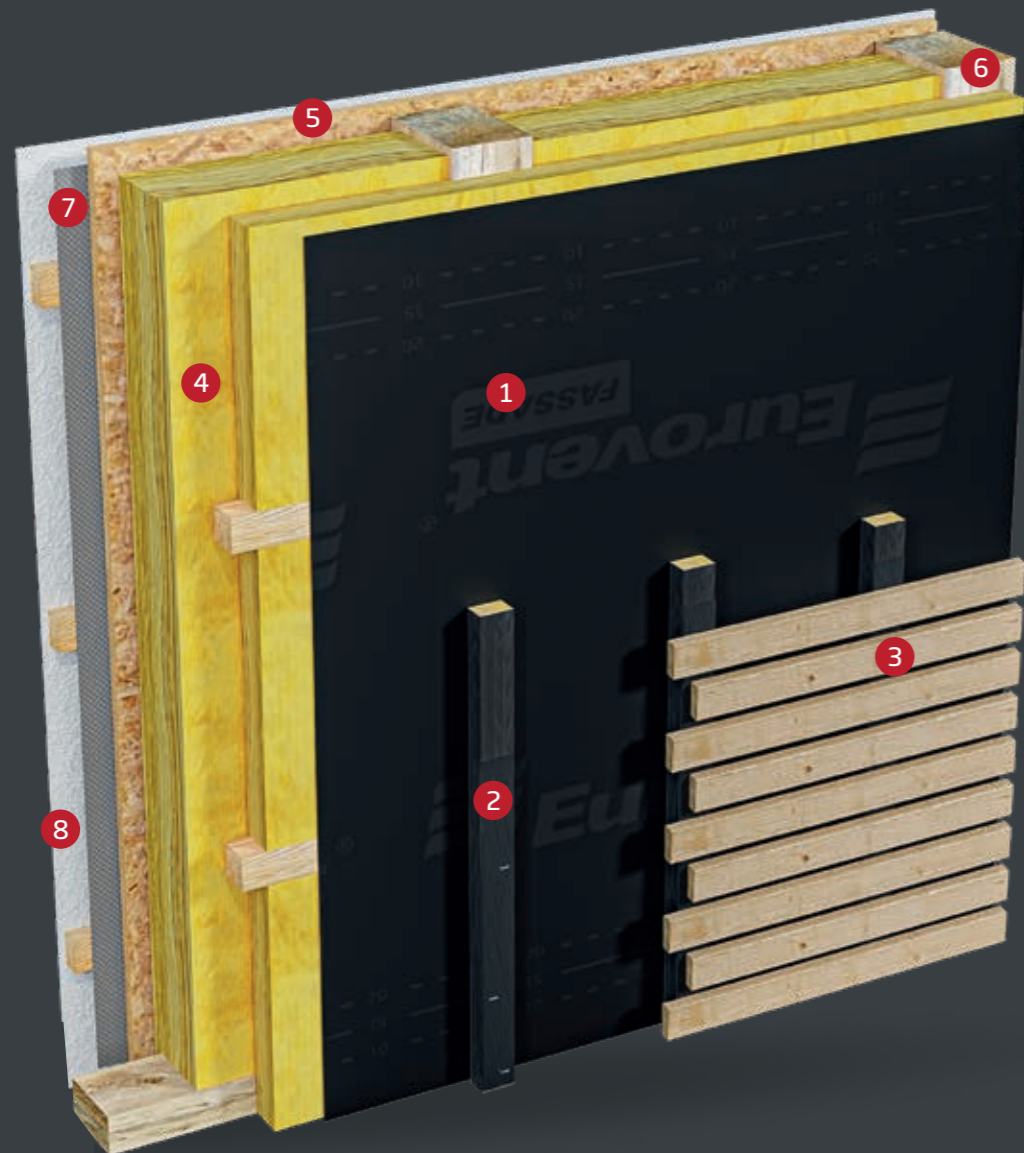

### › Eurovent® WALL PROTECT 3 in the closed facade

- |                            |
|----------------------------|
| 1 Eurovent® WALL PROTECT 3 |
| 2 Facade panels            |
| 3 Thermal insulation       |
| 4 OSB board                |
| 5 Construction             |
| 6 Eurovent® EPDM PRO       |

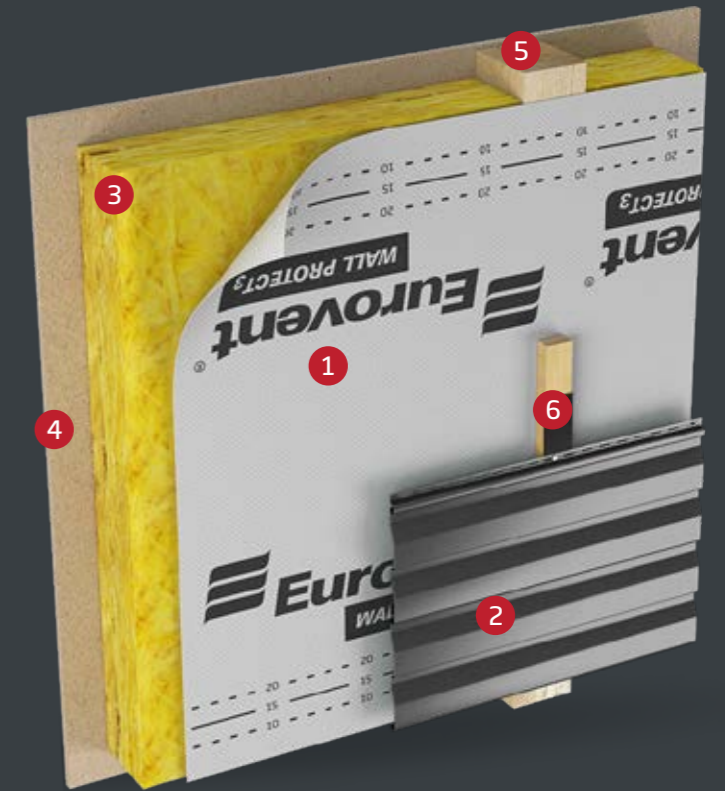

### › EUROVENT® HOME PRO in the closed facade

- |                      |
|----------------------|
| 1 Eurovent® HOME PRO |
| 2 Eurovent® AKTIV FR |
| 3 Facade panels      |
| 4 Thermal insulation |
| 5 Plasterboard       |
| 6 Construction       |
| 7 Eurovent® EPDM PRO |







## TEMPERATURE RESISTANCE

It is a material resistance to extreme temperatures influence. In case of a roof, we need to deal with high temperatures in summer and the minus ones in winter. Presumably, the temperatures present under the ventilated sloping roof surface do not exceed the 80°C level, therefore the DIN Standard predicts the study of roof membranes temperature resistance in the range from -40°C to +80°C, where the Eurovent® roof membranes are studied in a higher range, even up to 120°C. The roof membranes produced on the basis of propylene are being kept stable in the range from -40°C to +100°C, membranes of a higher standard even up to +120°C in the short duration conditions and there have been no changes observed when speaking in terms of a product's structure.

It has to be mentioned at the same time that the propylene softening temperature is > 120°C and its melting one – over ≥ 160°C.

When speaking in terms of roof membranes temperature resistance, proper roof installation is of a crucial importance here, as well as its transport from the eaves area to the ridge area. If this roof element is performed appropriately, both the membrane lifetime as well as its temperature resistance are significantly bigger in a particular period of time.

### ATTENTION:

- Ventilation on a sloping roof must be performed and pervious from an eaves to a ridge.

## UV RESISTANCE

It is resistance of a material to the UV radiation. The factor is one of the key ones that decide about a roof membrane lifetime on the grounds of polymers used in the production process, which are sensitive to UV radiation. The additives increasing the material resistance to UV radiation minimise the consequences of UV reaction. Nevertheless, excessively long exposing of a material without roof covering, so its constant exposure lead to its significant weakness or limit the product's lifetime. The lack of stabilising substances might bring such consequences as physical degradation or quicker decrease of a roof membrane technical qualities. In dependence of the exposure time and the radiation intensity, it is recommended to install the final roof covering on a roof in the time, not longer than 6 weeks from the moment of a roof membrane installation. Due to the additives applied, responsible for the UV resistance enhancement, it is a period which does not have any meaningful impact on the way of a product use value decline.

The UV radiation influence on the roof membranes are divided on the direct ones which have an impact on a membrane while installing it on a roof and the indirect ones that influence a membrane, e.g. as a result of the radiation's penetration on an attic through roof windows, roof hatch or slits in the load-bearing structure of a roof covering. Therefore, it is important to enable the influence of daylight effect on a roof membrane through its complete covering or an attic obscuring. Otherwise, the penetrated UV radiation will effect the exposed roof membrane, then its influence can lead to physical changes in the material structure.

### ATTENTION:

- Smaller UV radiation equals longer lifetime of a roof membrane
- Install the final roof covering up to 6 weeks from the moment of a roof membrane installation.







## › Insulating foils



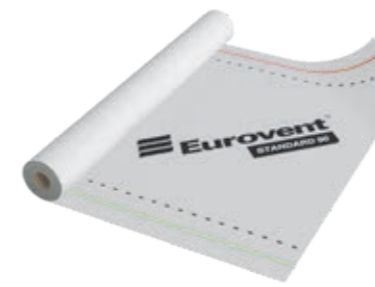

Vapour-permeable roof foils and vapour-barrier foils.

They are used as an initial covering layer, insulating layer for sloping and flat roofs, and as an insulation of vertical and horizontal constructions too.



### STANDARD





- Micro-perforated, vapour-permeable roof foil, reinforced with PE mesh.
- For non-insulated and ventilated pitched roofs.
- Dedicated to non sarking roof.

 ca. 90 g/m<sup>2</sup> | 
  ca. 1 m | 
  1,5 m x 50 rm | 
  120 Rolls



### SPECIAL





- Micro-perforated, vapour-permeable roof foil, reinforced with PE mesh.
- For non-insulated and ventilated pitched roofs.
- Dedicated to non sarking roof.

 ca. 110 g/m<sup>2</sup> | 
  ca. 1 m | 
  1,5 m x 50 rm | 
  120 Rolls



### SPECIAL FR<sub>5000</sub>

- Micro-perforated, vapour-permeable roof foil, reinforced with PE mesh.
- For non-insulated and ventilated pitched roofs.
- Dedicated to non sarking roof.
- Increased flammability class - B-s1, d0.

 ca. 110 g/m<sup>2</sup> | 
  ca. 1 m | 
  2 m x 50 rm | 
  120 Rolls

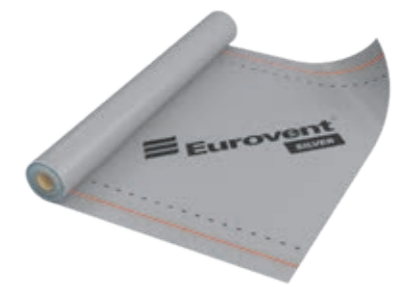

### SILVER

- Micro-perforated vapour-permeable roof foil.
- Made of coated polymer fabric.
- For non-insulated and ventilated pitched roofs.
- Dedicated to non sarking roof.



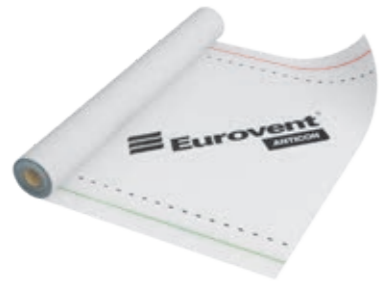

 ca. 90 g/m<sup>2</sup> | 
  ca. 1 m | 
  1,5 m x 50 rm | 
  120 Rolls





## ANTICON





- Multilayer, anti-condensation foil, made of fabric and polymer nonwovens.
- Recommended for ventilated pitched roofs, both insulated and non-insulated, as well as for metal roof.
- Prevents condensation effects.

			
ca. 110 g/m <sup>2</sup> ca. 130 g/m <sup>2</sup>	ca. 40 m	1,5 m x 50 rm	120 Rolls



## STANDARD N





- Reinforced vapour insulation foil.
- Used for pitched roofs as well as for wall constructions as an isolation protective layer.
- Protects against the penetration of water vapour and moisture.
- Extremely resistant to tearing.

			
ca. 90 g/m <sup>2</sup>	≥ ca. 40 m	1,5 m x 50 rm	120 Rolls



## SPECIAL N



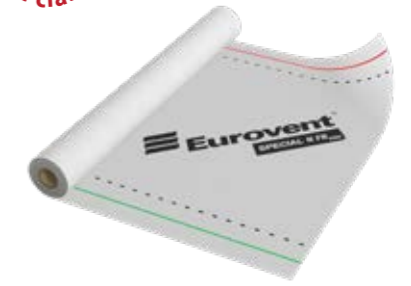

- Reinforced vapour insulation foil.
- Used for pitched roofs as well as for wall constructions as an isolation protective layer.
- Protects against the penetration of water vapour and moisture.
- Extremely resistant to tearing.

			
ca. 110 g/m <sup>2</sup>	≥ ca. 40 m	1,5 m x 50 rm	120 Rolls



## SPECIAL N FR<sub>5000</sub>

- Reinforced vapour insulation foil.
- Used for sloping and flat roofs as well as for wall constructions as an isolation protective layer.
- Protects against the penetration of water vapour and moisture.
- Increased flammability class - B-s1, d0.

			
ca. 110 g/m <sup>2</sup> ca. 140 g/m <sup>2</sup>	ca. 50 m	2 m x 50 rm	120 Rolls 100 Rolls

### › Application of roof foil

- 1 Eurovent® SILVER
- 2 Eurovent® PUR
- 3 Batten
- 4 Rafter
- 5 Thermal insulating
- 6 Vapour barrier

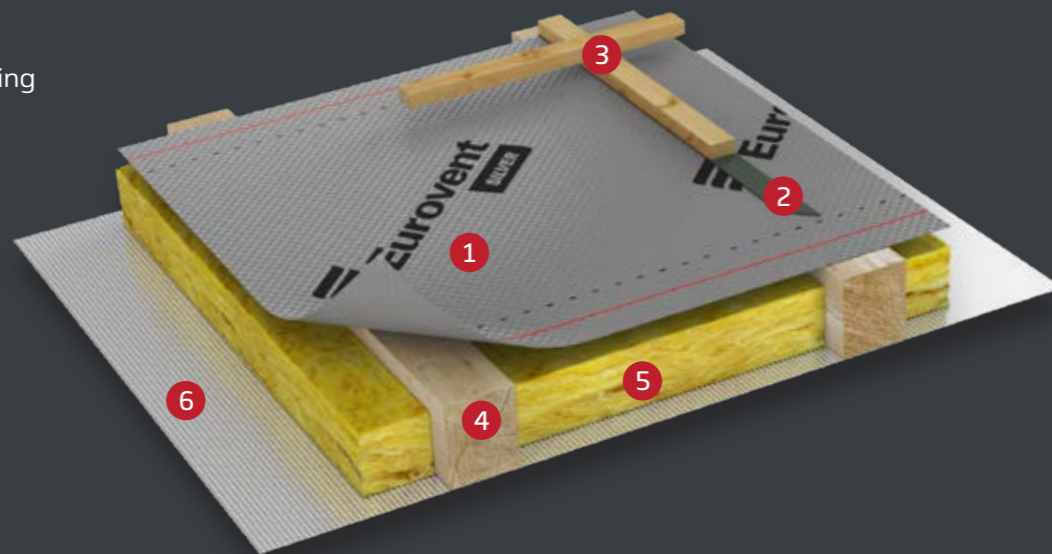

### › Application of vapour barrier foil

- 1 Eurovent® STANDARD ALU
- 2 Eurovent® ALUFIX
- 3 Plasterboard
- 4 Rafter
- 5 Thermal insulating
- 6 Roof tile

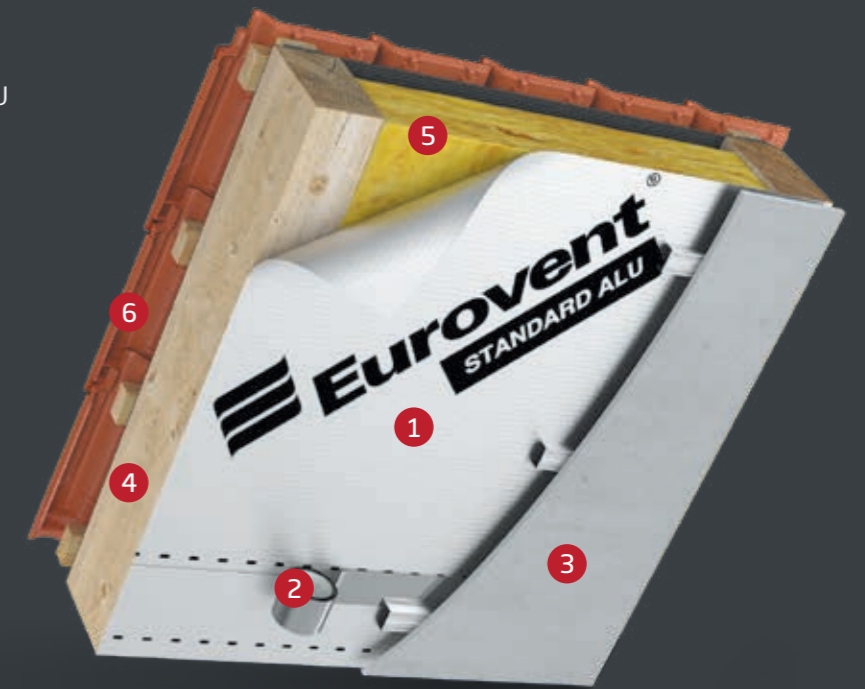



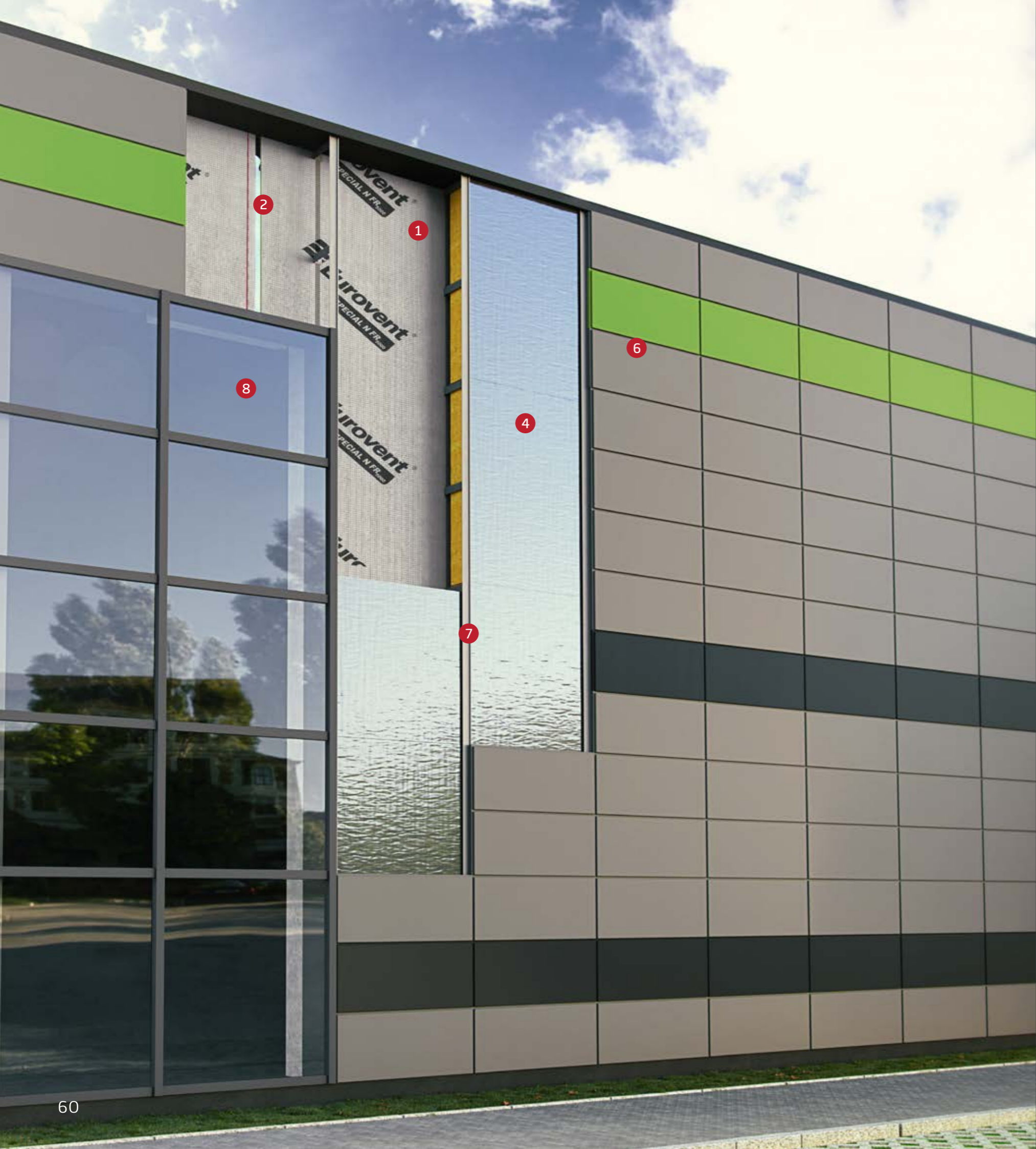

# SPECIAL N FR 5000

Eurovent® SPECIAL N FR 5000 – highly fire retardant vapour barrier layer used in wall and roof structures. Eurovent® SPECIAL N FR 5000 reached the fire reaction classification of B-s1, d0 according to the EN 13501. At the same time the product is air-, vapour- and watertight – reduces the condensation risk. It prevents the insulation against warm moist air escaping from inside of the building. The vapour barrier is recommended to be applied both in new constructions and renovation projects.

Eurovent® SPECIAL N FR 5000 is available in two weights: 110 and 140 g/m<sup>2</sup> at convenient application width of 2,0 m. The product consists of three layers: two layers of polymer foil and HDPE mesh, which ensures increased tensile strength. It is strongly recommended that the overlaps are tightly sealed with dedicated Eurovent® tape.

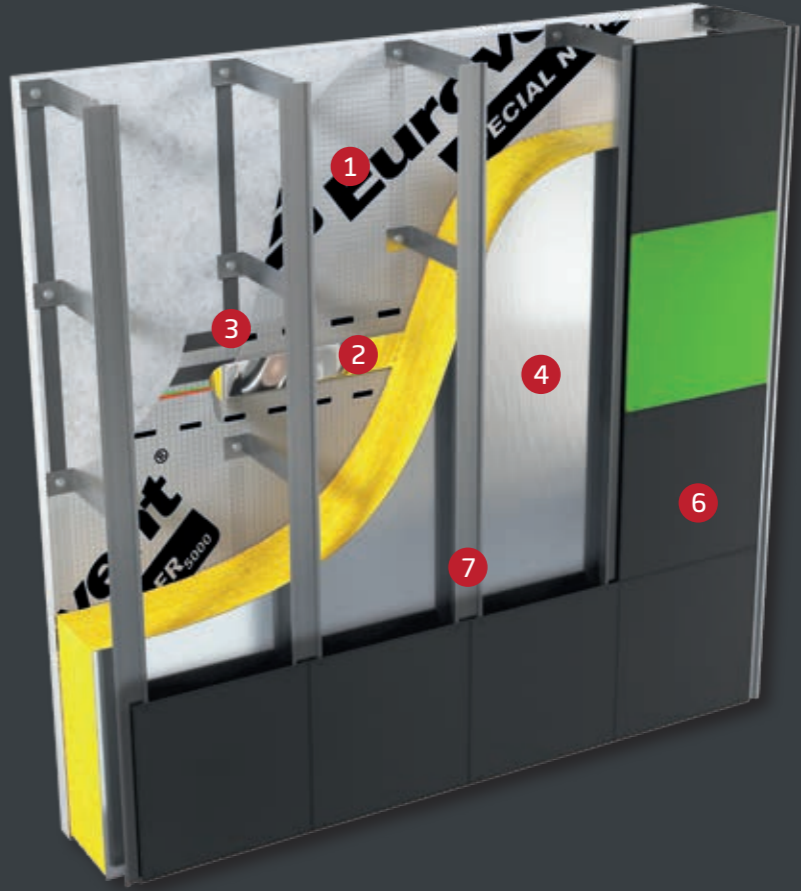

- 1 Eurovent® SPECIAL FR 5000
- 2 Eurovent® ALUFIX
- 3 Eurovent® BUTYL PRO
- 4 Thermal insulating
- 6 Facade panels
- 7 Construction
- 8 Window panels



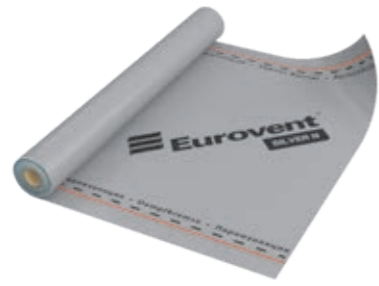

## SILVER N

- Vapour barrier foil, made of coated polymer fabric.
- Used for pitched roofs as well as for wall constructions as an isolation protective layer.
- Protects against the penetration of water vapour and moisture.
- Extremely resistant to tearing.



ca. 90 g/m<sup>2</sup> | ca. 40 m | 1,5 m x 50 rm | 120 Rolls



## STANDARD ALU

- Metallized vapour barrier foil, reinforced PE mesh.
- Used for wall, roof and ceiling constructions as an isolation protective layer.
- Its metallized surface reflects heat rays.
- Class B-s1, d0 available on request.



ca. 90 g/m<sup>2</sup>  
ca. 110 g/m<sup>2</sup>  
ca. 130 g/m<sup>2</sup>  
ca. 150 g/m<sup>2</sup>  
ca. 180 g/m<sup>2</sup>

ca. 150 m | 1,5 m x 50 rm

150 g/m<sup>2</sup>: 60 Rolls  
180 g/m<sup>2</sup>: 60 Rolls  
other: 120 Rolls

### › Eurovent® DB as an attic vapour barrier

- 1 Eurovent® DB
- 2 Eurovent® DUO
- 3 Thermal insulation
- 4 Plasterboard construction
- 5 Plasterboard
- 6 Rafter

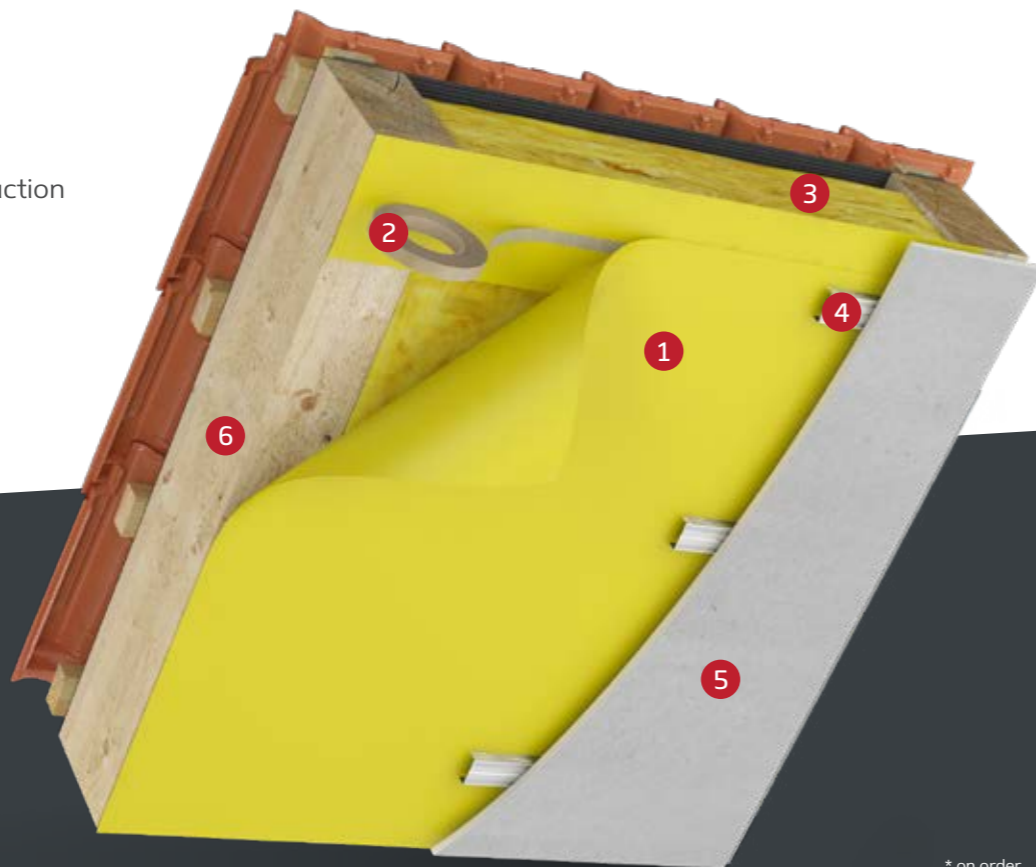

## DB

- One-layered polyethylene vapour barrier foil
- Resistant to tearing
- Used as an isolation in wall, roof and ceiling constructions.
- Suitable for use as acoustic insulation for floor finishing works.



ca. 0,20 mm | ca. 50 m | 2 m x 50 rm | 80 Rolls

### › Eurovent® BAU as a dampproof insulation

- 1 Eurovent® BAU
- 2 Foundation
- 3 Thermal insulation
- 4 Screed
- 5 Floor

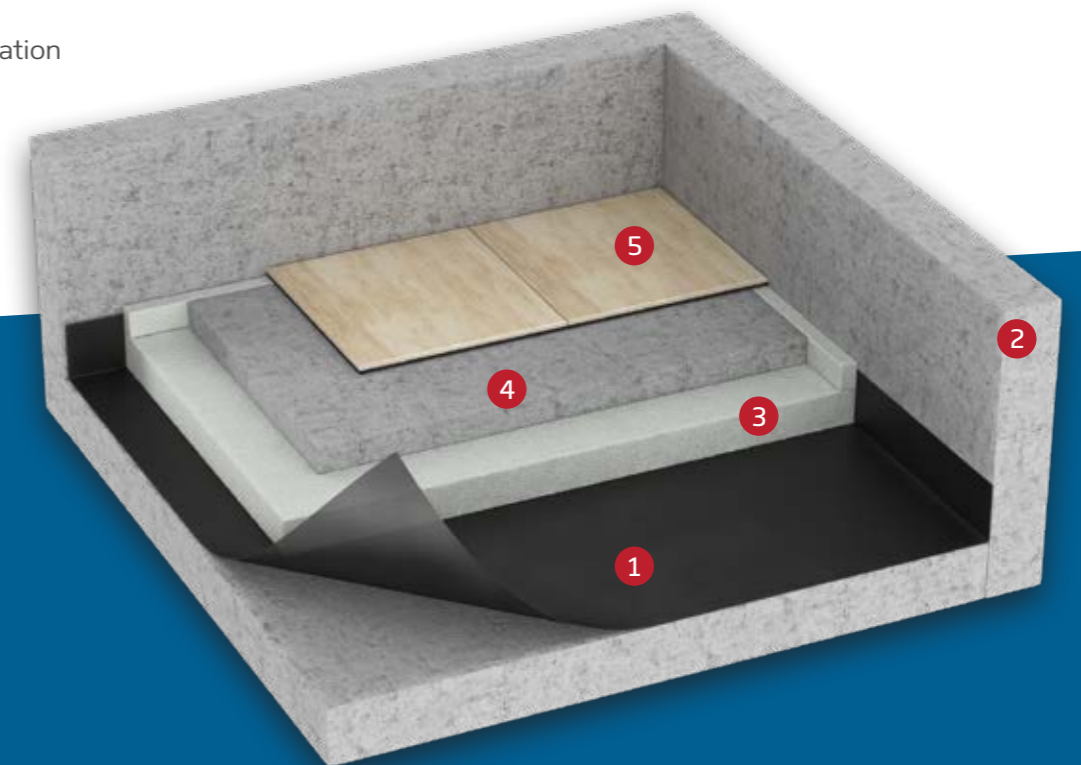



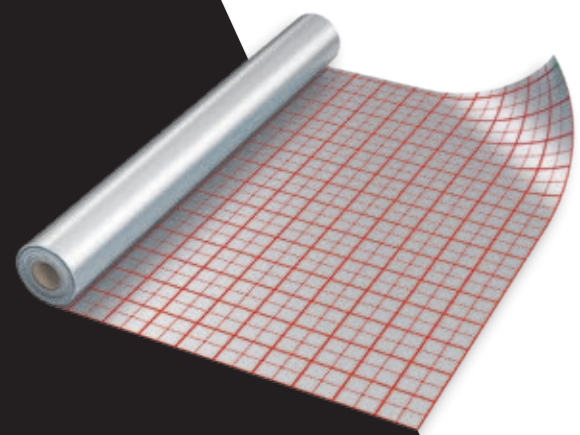

## ALUFLOOR

- Two-layer, laminated isolation foil, printed and metalized on one side.
- Recommended as an isolation layer for floor heating as well as under and for heating elements.
- Used as a floor vapour barrier layer.



ca. 110 g/m<sup>2</sup>



ca. 70 m



1,0 m x 50 m



120 Rolls

### › Eurovent® ALUFLOOR in the underfloor heating system

- 1 Eurovent® ALUFLOOR
- 2 Eurovent® BAU
- 3 Concrete
- 4 Thermal insulation
- 5 Underfloor heating
- 6 Screed
- 7 Floor

### + PRACTICAL

Surprinted grid on the entire foil surface makes assembly of the heating installation easier.

### + INSULATING



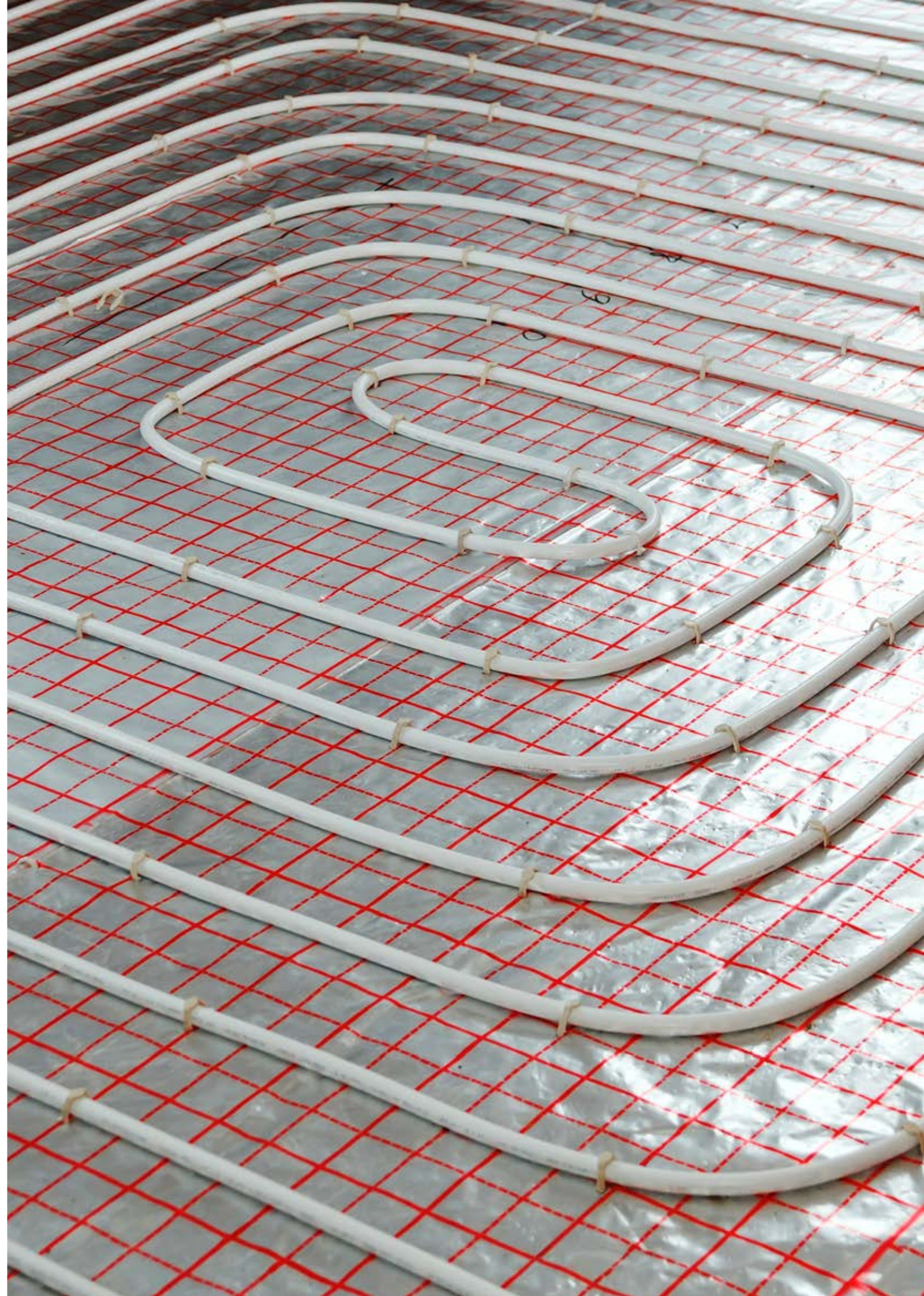
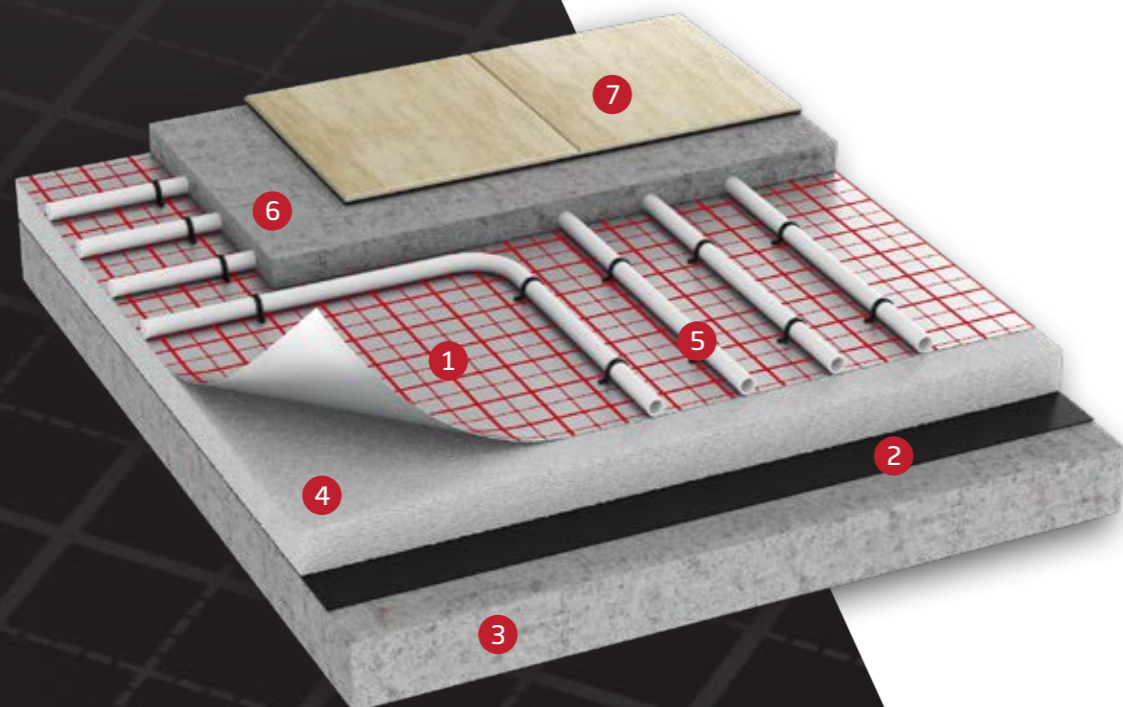

Effectively insulates and protects against vapour and moisture coming from mortar.

### + REFLECTIVE

Effectively reflects thermal radiation in a room direction.





ROOF MEMBRANES					
BASIC	ca. 100 g/m <sup>2</sup>	ca. 0,02 m	E	-40°C to +100°C	15
CLASSIC	ca. 120 g/m <sup>2</sup>	ca. 0,02 m	E	-40°C to +100°C	15
HOME PRO	ca. 135 g/m <sup>2</sup>	ca. 0,02 m	E	-40°C to +100°C / 120°C*	16
MAXI	ca. 140 g/m <sup>2</sup>	ca. 0,02 m	E	-40°C to +100°C / 120°C*	16
MAXI PLUS	ca. 150 g/m <sup>2</sup>	ca. 0,02 m	E	-40°C to +100°C / 120°C*	17
STRONG	ca. 160 g/m <sup>2</sup>	ca. 0,02 m	E	-40°C to +100°C / 120°C*	17
SUPER	ca. 170 g/m <sup>2</sup>	ca. 0,02 m	E	-40°C to +100°C / 120°C*	20
RFLEX	ca. 160 g/m <sup>2</sup>	ca. 0,02 m	E	-40°C to +100°C / 120°C*	20
VSTRONG	ca. 200 g/m <sup>2</sup>	ca. 0,02 m	E	-40°C to +100°C / 120°C*	20
XSTRONG	ca. 250 g/m <sup>2</sup>	ca. 0,04 m	E	-40°C to +100°C / 120°C*	20
SUPER SA	ca. 230 g/m <sup>2</sup> ca. 270 g/m <sup>2</sup>	ca. 0,17 m ca. 0,19 m	E	-40°C do +100°C / 120°C*	22
COMFORT	ca. 220 g/m <sup>2</sup>	ca. 0,03 m	E	-40°C to +100°C / 120°C*	25
STRATOS	ca. 210 g/m <sup>2</sup>	ca. 0,02 m	B-s1, d0	-40°C to +100°C / 120°C*	25
MONO	ca. 260 g/m <sup>2</sup> ca. 335 g/m <sup>2</sup>	ca. 0,3 m ca. 0,5 m	E	-40°C to +100°C / 120°C*	25
MAGNUM	ca. 210 g/m <sup>2</sup>	ca. 0,15 m	E	-40°C to +100°C / 120°C*	25
BITUMI	ca. 450 g/m <sup>2</sup>	ca. 50 m	E	-40°C to +100°C	26
SYNTEX	ca. 170 g/m <sup>2</sup>	ca. 40 m	E	-40°C to +100°C	26
METALLIC	ca. 450 g/m <sup>2</sup>	ca. 0,02 m	E	-40°C to +100°C / 120°C*	27
MATT	ca. 300 g/m <sup>2</sup>	-	F	-40°C to +100°C	27
<b>VAPOUR BARRIER MEMBRANES</b>					
AKTIV	ca. 90 g/m <sup>2</sup>	ca. 8 m	E	-40°C to +80°C / 100°C*	34
AKTIV 3	ca. 140 g/m <sup>2</sup> ca. 160 g/m <sup>2</sup>	ca. 10 m	E	-40°C to +80°C / 100°C*	34
CLIMA	ca. 85 g/m <sup>2</sup>	ca. 2 - 16 m	E	-40°C to +80°C / 100°C*	34
CLIMA X	ca. 115 g/m <sup>2</sup>	ca. 2 - 16 m	E	-40°C to +80°C / 100°C*	34
AKTIV FR	ca. 150 g/m <sup>2</sup>	ca. 150 m	B-s1, d0	-40°C to +80°C / 100°C*	36
AKTIV ALU	ca. 110 g/m <sup>2</sup>	ca. 40 m	E	-40°C to +80°C / 100°C*	36
AKTIV PRO	ca. 830 g/m <sup>2</sup>	ca. 4000 m	A1	-	44-45
<b>WIND BARRIER MEMBRANES</b>					
WALL PROTECT	ca. 100 g/m <sup>2</sup>	ca. 0,02 m	E	-40°C to +100°C	48
WALL PROTECT 3	ca. 90 g/m <sup>2</sup>	ca. 0,02 m	E	-40°C to +100°C	48
HOME PRO	ca. 135 g/m <sup>2</sup>	ca. 0,02 m	E	-40°C to +100°C / 120°C*	48
WALL PROTECT FR	ca. 150 g/m <sup>2</sup>	ca. 0,14 - 0,18 m	B-s1, d0	-40°C to +100°C	49
FASSADE	ca. 210 g/m <sup>2</sup>	ca. 0,02 m	B-s1, d0	-40°C to +100°C / 120°C*	49
FIBER PRO	ca. 1388 g/m <sup>2</sup>	ca. 0,05 m	A2-s1, d0	-	50-51
<b>ROOF FOILS</b>					
STANDARD	ca. 90 g/m <sup>2</sup>	ca. 1 m	F	-40°C to +80°C	57
SPECIAL	ca. 110 g/m <sup>2</sup>	ca. 1 m	F	-40°C to +80°C	57
SPECIAL FR <sub>5000</sub>	ca. 110 g/m <sup>2</sup>	ca. 1 m	B-s1, d0	-40°C to +80°C / 100°C*	57
SILVER	ca. 90 g/m <sup>2</sup>	ca. 1 m	F	-40°C to +80°C	57
ANTICON	ca. 110 g/m <sup>2</sup> ca. 130 g/m <sup>2</sup>	ca. 40 m	F	-40°C to +80°C	58
<b>VAPOUR BARRIER FOILS</b>					
STANDARD N	ca. 90 g/m <sup>2</sup>	ca. 40 m	F	-40°C to +80°C	58
SPECIAL N	ca. 110 g/m <sup>2</sup>	ca. 40 m	F	-40°C to +80°C	59
SPECIAL N FR <sub>5000</sub>	ca. 110 g/m <sup>2</sup> ca. 140 g/m <sup>2</sup>	ca. 50 m	B-s1, d0	-40°C to +80°C / 100°C*	59
SILVER N	ca. 90 g/m <sup>2</sup>	ca. 40 m	F	-40°C to +80°C	62
STANDARD ALU	ca. 90 g/m <sup>2</sup> ca. 110 g/m <sup>2</sup> ca. 130 g/m <sup>2</sup> ca. 150 g/m <sup>2</sup> ca. 180 g/m <sup>2</sup>	ca. 150 m	F; B-s1, d0	-40°C to +80°C / 100°C*	62
DB I BAU	-	ca. 50 m	F	-40°C to +80°C	63
ALUFLOOR	ca. 110 g/m <sup>2</sup>	ca. 70 m	F	-40°C to +80°C	64



## › Ridge

Ridge tapes and accessories enable proper ridge ventilation while protecting it against penetration of drifted in snow, rain, moisture and dust.





# RIDGE TAPE

The ROLL STANDARD ridge tape is designed for horizontal and sloping ridges. It protects the roof covering against penetration of snow, rain, moisture and dust blown in from the ridge side while ensuring ventilation from the thermal insulation side too.

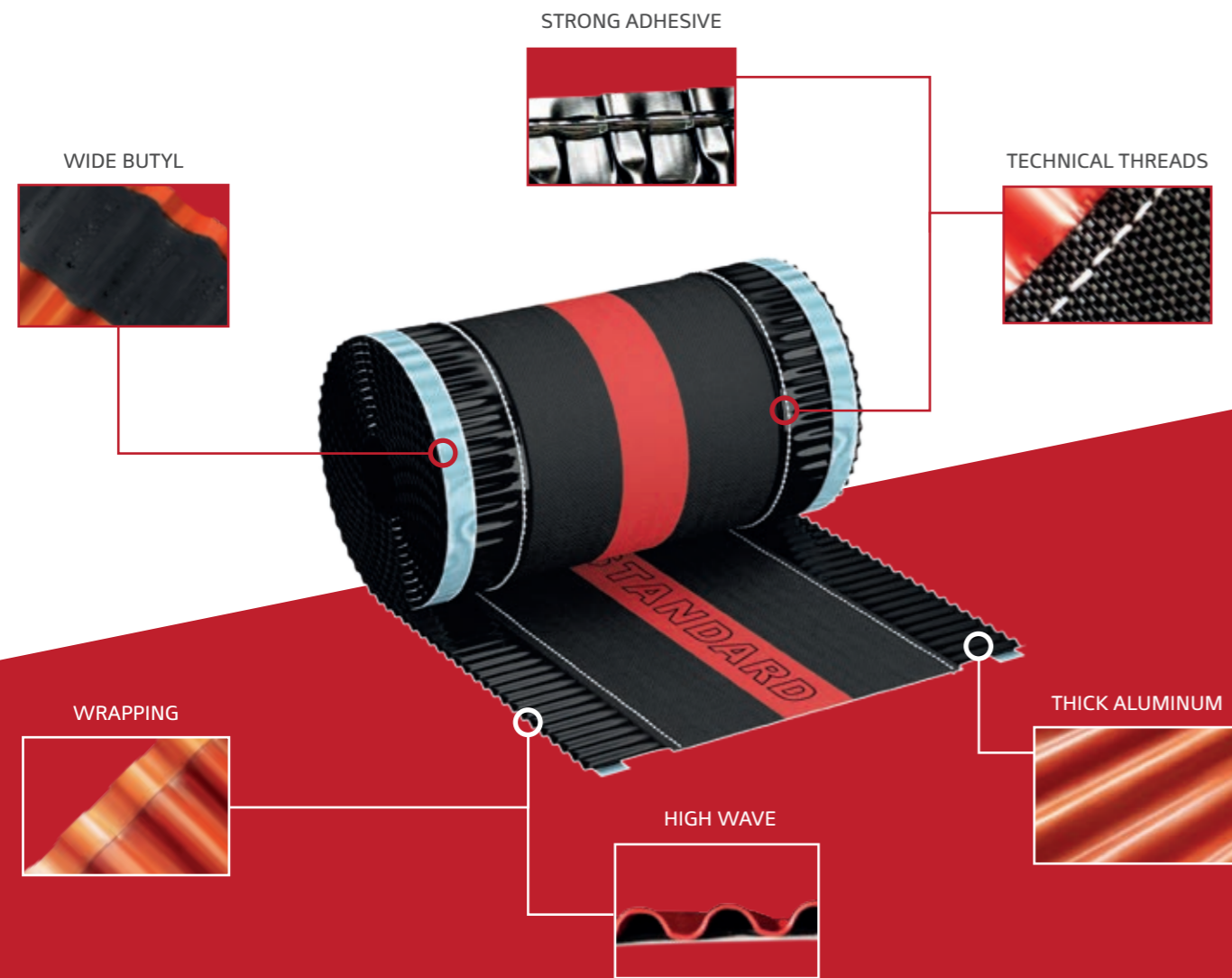

## + WRAPPING

Wrapped edges protect against split.

## + BUTYL

20 mm, strong and durable adhesion for roof coverings.

## + WAVE

4 mm, finishing work can be carried out in case of every roof covering.





## + ALUMINUM

0,14 mm, resistant to breaking, easy in case of forming aluminum.



## ROLL STANDARD



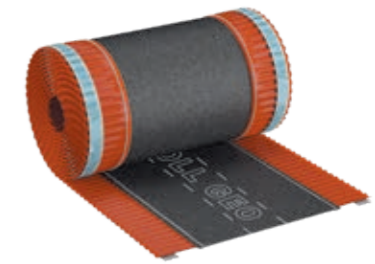

- Ridge tape made of profiled aluminum sheet, technical fabric and butyl tape
- Ensures ventilation and roof slopes protection against moisture and dust.

 240 mm x 5 rm; 310 mm x 5 rm; 390 mm x 5 rm	 RAL: 8004; 8019; 9005; 7021; 8015; 3011; 8017; copper-CU*
 4 rolls	 240 mm: 168 rolls 310 mm: 144 rolls 390 mm: 100 rolls



## ROLL GEO





- Ridge tape made of profiled aluminum sheet, geotextile and butyl tape.
- Ensures ventilation and roof slopes protection against moisture and dust.

 180 mm x 5 rm; 240 mm x 5 rm; 310 mm x 5 rm; 390 mm x 5 rm	 RAL: 8004; 8019; 9005; 7021; 8015; 3011; 8017; copper-CU*
 4 rolls	 180 mm: 192 rolls 240 mm: 168 rolls 310 mm: 144 rolls 390 mm: 100 rolls



## ROLL SUPER





- Ridge tape made of profiled aluminum sheet, double-sided nonwoven and butyl tape.
- Ensures ventilation and roof slopes protection against moisture and dust.

 240 mm* x 5 rm; 310 mm x 5 rm; 390 mm x 5 rm	 RAL: 8004; 8019; 9005; 7021; 8015; 3011; 8017; copper-CU*
 4 rolls	 240 mm*: 168 rolls 310 mm: 144 rolls 390 mm: 100 rolls



## ROLL ECCO

- Ridge tape made of profiled aluminum sheet, PP nonwoven and butyl tape.
- Ensures ventilation and roof slopes protection against moisture and dust.

 180 mm x 5 rm; 240 mm x 5 rm; 310 mm x 5 rm; 390 mm x 5 rm	 RAL: 8004; 8019; 9005; 7021; 8015; 3011; 8017
 4 rolls	 180 mm: 192 rolls 240mm: 168 rolls 310 mm: 144 rolls 390 mm: 100 rolls





\* on order





## ROLL TEC





- Ridge tape made of pleated PET foil, PP nonwoven and butyl tape.
- Ensures ventilation and roof slopes protection against moisture and dust.

 310 mm x 5 rm; 390 mm x 5 rm	 RAL: 8004; 8019; 9005; 7021; 8017
 4 rolls	 310 mm: 144 rolls 390 mm: 100 rolls



## ROLL METAL



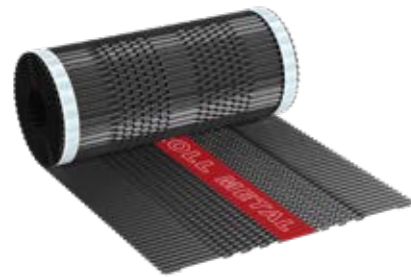

- Ridge tape made of partly perforated profiled aluminum sheet and butyl tape.
- Ensures ventilation and roof slopes protection against moisture and dust.

 300 mm x 5 rm; 400 mm x 5 rm	 RAL: 8004; 8019; 9005; 7021; 8015; 3011; 8017; copper-CU*
 4 rolls	 300 mm: 144 rolls 400 mm: 100 rolls



## ROLL METAL NEW



- Ridge tape made of perforated profiled aluminum sheet and butyl tape.
- Ensures increased ventilation and roof slopes protection against moisture and dust.

 300 mm x 5 rm; 400 mm x 5 rm	 RAL: 8004; 8019; 9005; 7021; 8015; 3011; 8017; copper-CU*
 4 rolls	 300 mm: 144 rolls 400 mm: 100 rolls



## GRIP UNI





- Ridge tile grip made of aluminum sheet, coated with polyester paint.
- For fast and reliable installation of ridge tiles on the ridge and hip battens.
- The grip is mounted with the use of screws.

			
470/53	RAL: 8004; 8017; 3009; 7021	50 pcs.	10 000 pcs.



## GRIP CREATON





- Ridge tile grip made of aluminum sheet, coated with polyester paint.
- For fast and reliable installation of Creaton; Tondach; Koramic ridge tiles on the ridge and hip battens.
- The grip is mounted with the use of screws.

			
470/24	RAL: 8004; 8017; 7021	50 pcs.	10 000 pcs.



## GRIP RÖBEN

- Ridge tile grip made of aluminum sheet, coated with polyester paint.
- For fast and reliable installation of Röben ridge tiles on the ridge and hip battens.
- The grip is mounted with the use of screws.

			
470/163	RAL: 8004; 8017; 7021; 9005	50 pcs.	10 000 pcs.





### CANTILEVER G

- Ridge batten bracket, consists of a nail and a steel grip.
- Used on sloping, ventilated roofs for the installation of a ridge batten.

40 mm 50 mm	180 mm; 210 mm; 230 mm; 260 mm; 310* mm	100 pcs.	3200 pcs.



### CANTILEVER B

- Ridge batten bracket, called "sheet", consists of a steel grip and two bracket stalks.
- Used on sloping, ventilated roofs for the installation of a ridge batten.

40 mm 50 mm	210 mm	100 pcs.	3200 pcs.



### CANTILEVER N

- Ridge batten bracket, consists of a threaded nail and a steel grip.
- Used on sloping, ventilated roofs for the installation of a ridge batten.

40 mm 50 mm	180 mm; 260 mm; 320 mm	100 pcs.	3200 pcs.



### CANTILEVER L

- Regulated ridge batten bracket, consists of a steel grip and two bracket stalks.
- Used on sloping, ventilated roofs for the installation of a ridge batten.

40 mm 50 mm	205/225 mm	100 pcs.	3200 pcs.

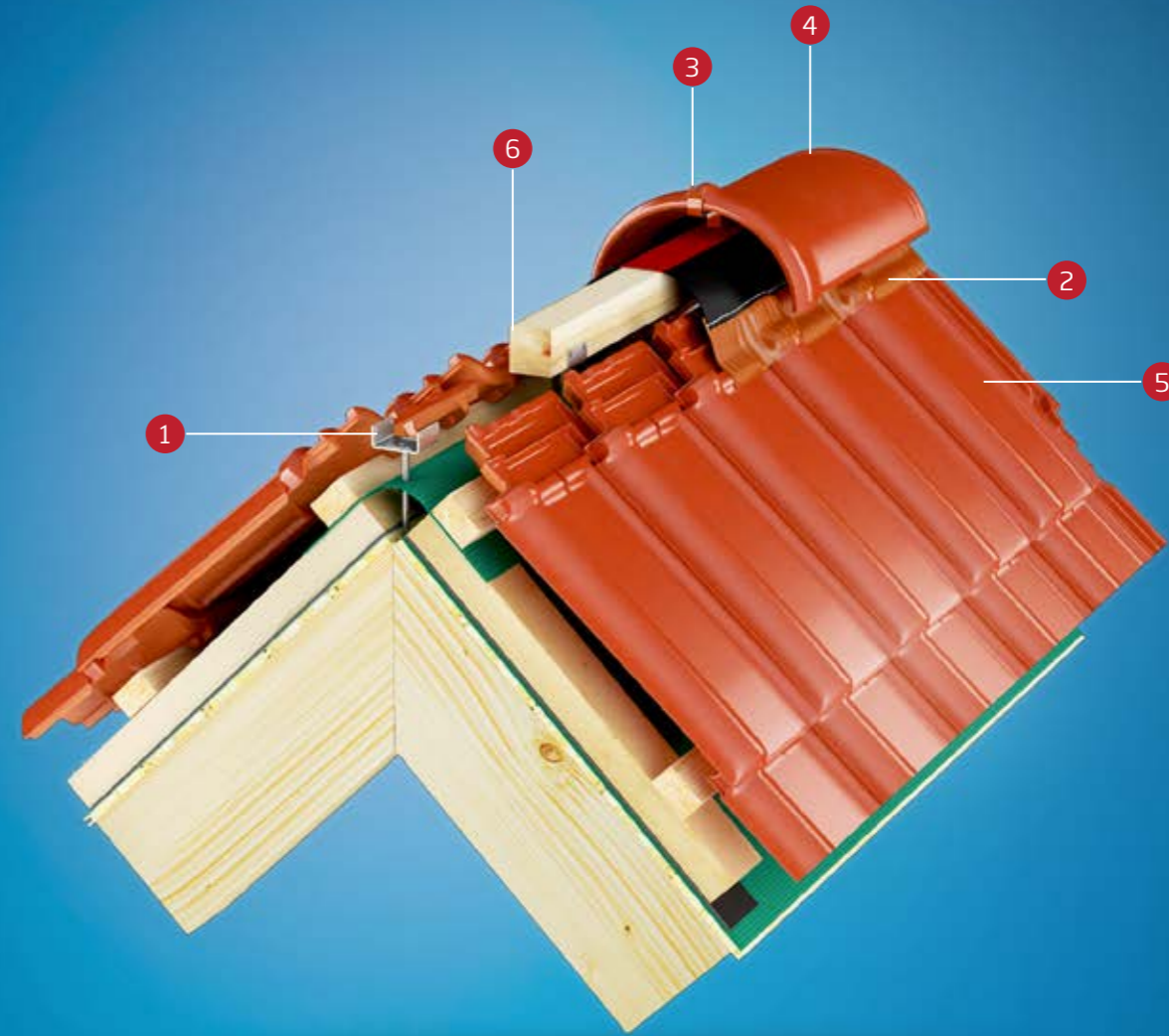

- 1 Eurovent® CANTILEVER G
- 2 Eurovent® ROLL STANDARD
- 3 Eurovent® GRIP UNI
- 4 Ridge tile
- 5 Roof tile
- 6 Ridge batten

### + VENTILATION

A ridge in the Eurovent® system ensures uncompromising ventilation of thermal insulation.

### + PROTECTION





Protects against penetration of snow blown from the ridge side, rain, moisture and dust.





## AIR FLEX S

- Ridge ventilating element made of PCV with ventilation openings and polymer bristles.
- Used as ventilating and sealing element.
- Protects the roof covering against moisture and dust. Ensures proper ventilation.

			
75 mm x 1000 mm	RAL: 8004; 8019; 9005; 7021; 8015; 3013	20 pcs.	200 pcs.

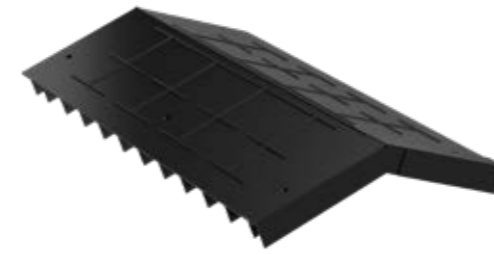

## BITUVENT





- Ridge ventilating element.
- Protects the roof covering against moisture and dust from the ridge side, ensures ventilation.
- Recommended for coverings with bituminous shingle. For sloping roofs of 5°-45° pitch.

			
290 mm x 1000 mm	RAL: 9005	10 pcs.	100 pcs.









## DECK

- Ridge cover made of synthetic material.
- Used as a ventilating, finishing element of a ridge tile by roof tiles.
- Equipped with special, evenly arranged openings which ensure effective ventilation.

			
165 mm x 220 mm	RAL: 8004; 8019; 9005	50 pcs.	12 250 pcs.

### › AIR FLEX S in the ridge ventilation system

- |  |  |
|--|--|
|  Eurovent® AIR FLEX S   |  Ridge batten   |
|  Eurovent® CANTILEVER G |  Counter batten |
|  Eurovent® SUPER        |  Ridge tile     |
|  Eurovent® GRIP UNI     |  |

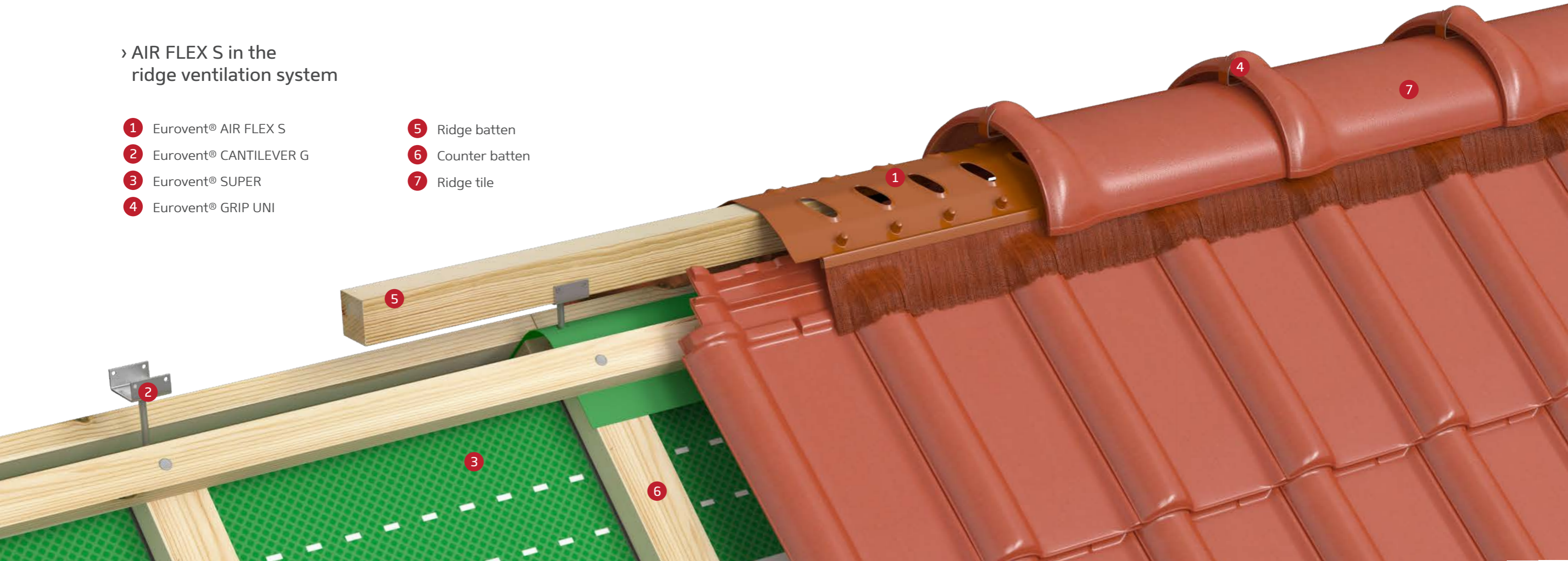



# RIDGE

Appropriately protected ridge area ensures good ventilation as well as protection against drifted snow, rain, moisture and dust.

- We apply an additional membrane strip of 40 cm width minimum along a ridge.
- Next we settle what the ridge batten height is and appropriately install the brackets.
- After the ridge batten installation we put ridge tape and fit it with staples.
- Tape sides are profiled in accordance with the roof sheathing shape, next the liner that protects the butyl adhesive becomes peeled and the tape sides are tightened to the sheathing.
- When the ridge is finished, we install the cover of a ridge ending.
- Then ridgetiles are installed by the use of clips.

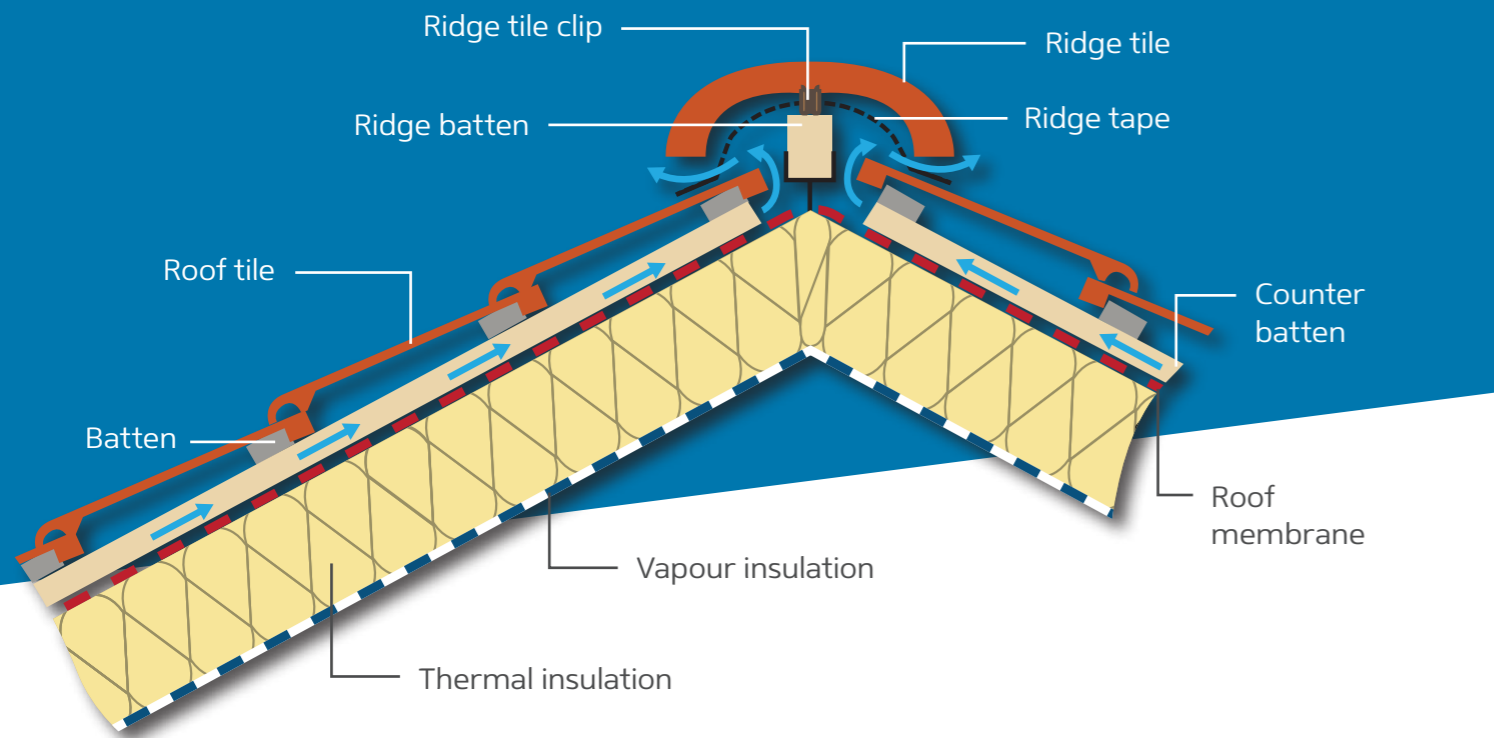

Instruction of the Eurovent® ridge tape installation

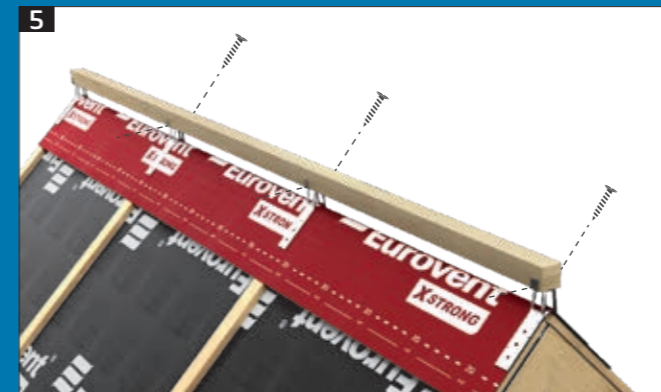
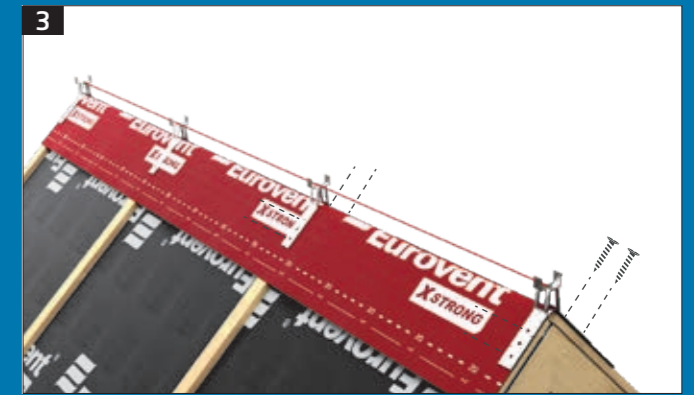
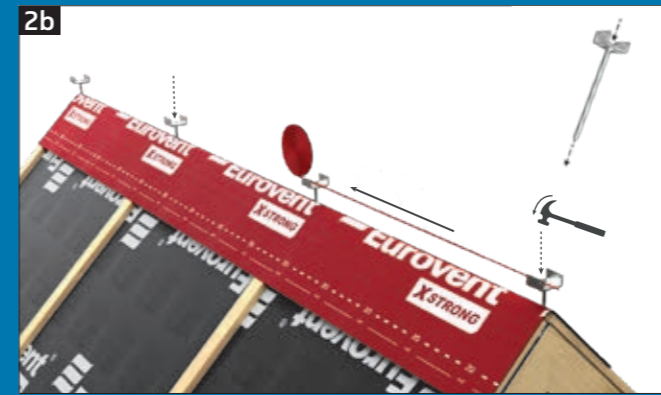
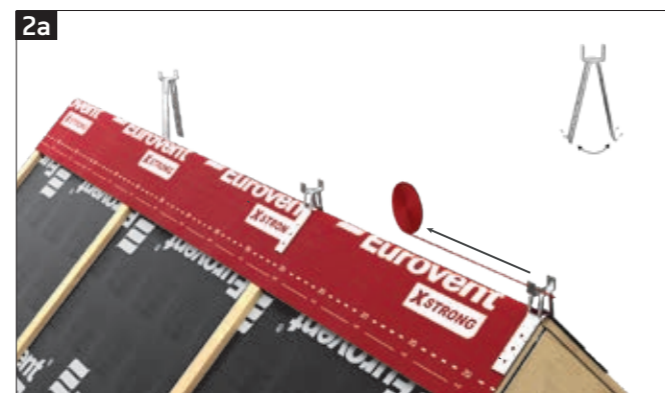







## › Chimney

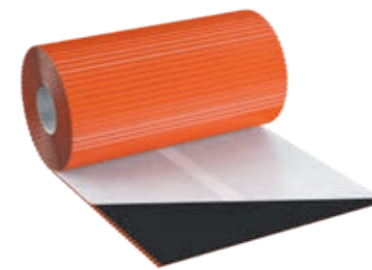

Chimney flashing for tight and durable chimney finishing work, bay and roof windows as well as wall and roof joinings.



### FLEX STANDARD

- Chimney flashing tape made of crosswise profiled aluminum sheet and butyl glue.
- Used for roof, chimney, bay and roof windows finishing works.



 300 mm x 5 m
  RAL: 8004; 8017; 8019; 9005; 7021; 8015; 3011; copper - Cu\*



 1 roll
  144 rolls



### FLEX 3D

- Chimney flashing tape made of profiled in a three-dimensional pattern aluminum sheet and butyl glue.
- Used for roof, chimney, bay and roof windows finishing works.



 300 mm x 5 m
  RAL: 8004; 8017; 8019; 9005; 7021; 8015; 3011; copper - Cu\*



 1 roll
  144 rolls



### FLEX 4D

- Chimney flashing tape made of profiled in a four-dimensional pattern aluminum sheet and butyl glue.
- Used for roof, chimney, bay and roof windows finishing works.



 300 mm x 5 m
  RAL: 8004; 8017; 8019; 9005; 7021; 8015; 3011; copper - Cu\*

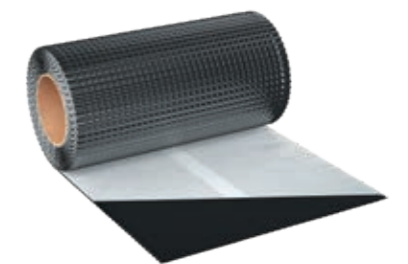

 1 roll
  144 rolls



### FLEX STANDARD PB

- Chimney flashing tape made of crosswise profiled 0,2 mm thick lead sheet and butyl glue.
- Used for roof, chimney, bay and roof windows finishing works.

 300 mm x 5 m
  RAL: 8004; 8017; 8019; 9005; 7021

 1 roll
  72 rolls

\* on order



# CHIMNEY TAPE

The Eurovent® FLEX EPDM chimney flashing tape made of a high-quality reinforcing mesh, flexible EPDM layer and butyl glue covered with silicone paper. Characterized by high flexibility level and easy to carry out – finishing work. Used for all kinds of sealing and connections within the roof, in particular for chimney area, bay windows and roof windows.

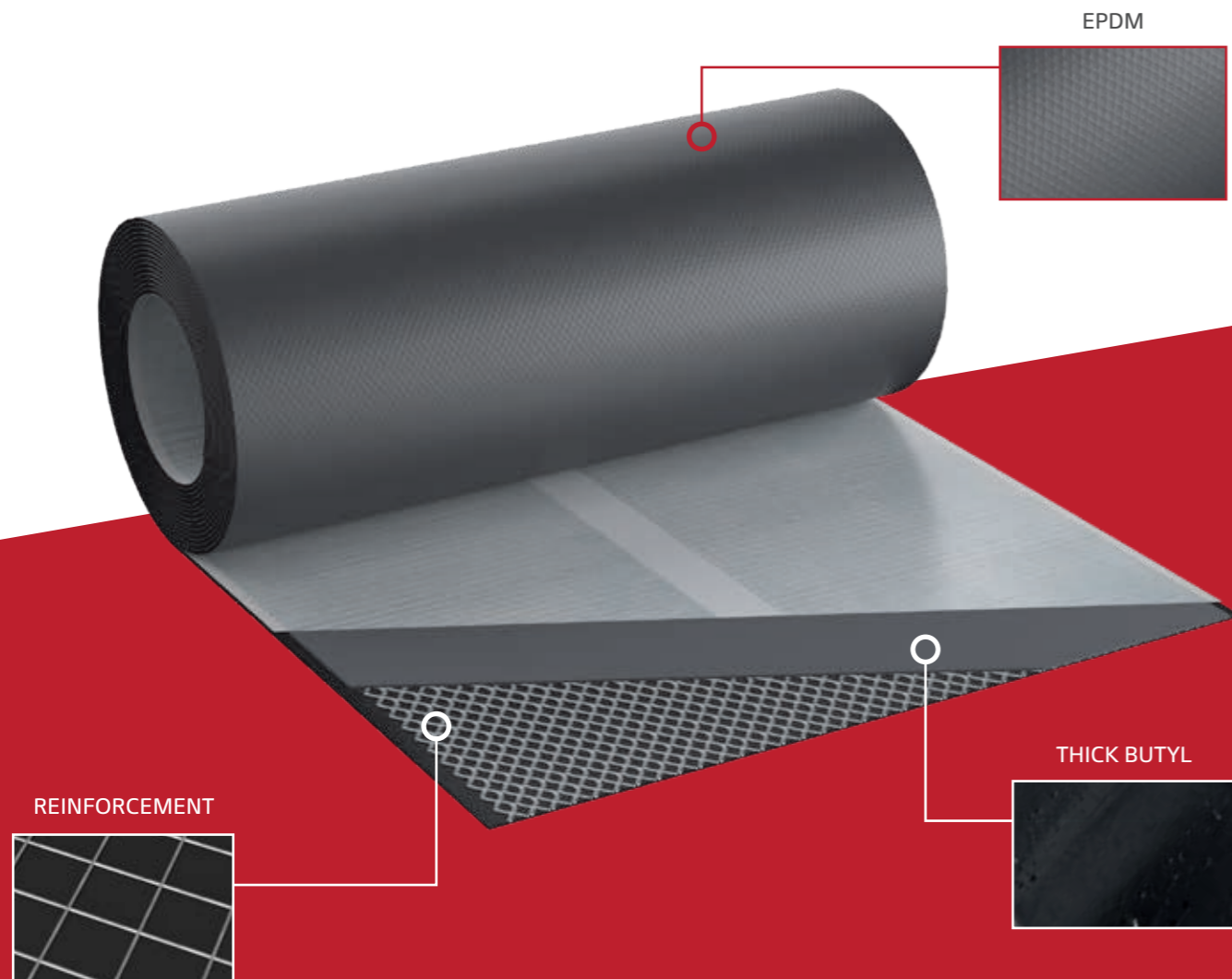

## + FLEXIBLE

1,5 mm, flexible, resistant to weather conditions EPDM.

## + REINFORCEMENT

0,5 mm, aluminum mesh strenghtens joining and enables easy finishing work.

## + JOINING

1 mm, butyl layer, ensures strong and durable joining.



### › FLEX STANDARD PB chimney finishing work

- 1 Eurovent® FLEX STANDARD PB
- 2 Eurovent® FLEX LINE
- 3 Chimney
- 4 Roof tile



## FLEX SUPER PB

- Chimney flashing tape made of crosswise profiled 0,4 mm thick lead sheet and butyl glue.
- Used for roof, chimney, bay and roof windows finishing works.

300 mm x 5 rm

RAL: 8004; 8017; 8019; 9005; 7021; 8015

1 roll

60 rolls



## FLEX FLAT PB

- Chimney flashing tape made of high quality 0,4 mm thick flat lead sheet and butyl glue covered with silicone paper.
- Used for roof, chimney, bay and roof windows finishing works.

300 mm x 5 rm

RAL: 8004; 8017; 8019; 9005; 7021; 8015

1 roll

60 rolls



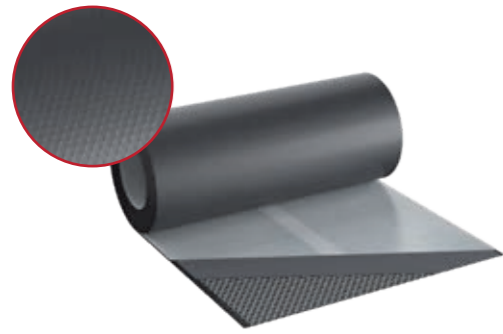

## FLEX EPDM

- Chimney flashing tape made of a high-quality aluminum mesh, EPDM layer and butyl glue.
- Used for roof, chimney, bay and roof windows finishing works.

 300 mm x 5 m
  RAL: 8004; 8017; 9005; 7024

 1 roll
  144 rolls

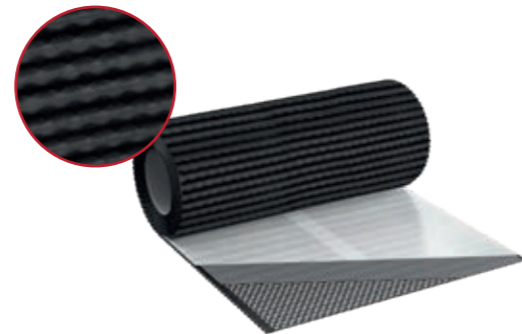

## FLEX EPDM Q

- Chimney flashing tape made of profiled in a three-dimensional pattern EPDM, aluminum mesh and butyl glue.
- Used for roof, chimney, bay and roof windows finishing works.



 300 mm x 5 m
  RAL: 8004; 8017; 9005; 7024

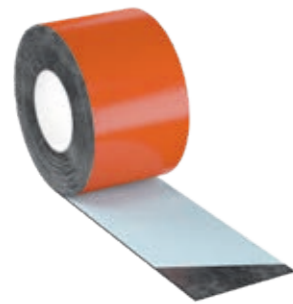

 1 roll
  144 rolls



## FLEXBIT

- Roofing tape made of aluminum foil and a bituminous glue.
- Used for repair and adhesion works in roofs in the chimney areas, roof windows, firewalls, roof valleys and ventilation elements.

 100 mm; 150 mm; 300 mm x 10 m
  Aluminum; RAL: 8004; 8017; 3004; 6020; 7016

 100 mm: 3 rolls  
 150 mm: 2 rolls  
 300 mm: 1 roll
  100 mm: 288 rolls  
 150 mm: 192 rolls  
 300 mm: 96 rolls



## FLEX LINE

- Chimney strip made of aluminum sheet.
- Used to ensures proper sealing of the critical spots around chimney and aesthetic finishing of the roof works.

 80 mm x 2 m
  RAL: 8004; 8017; 8019; 9005; 7021

 20 pcs.
  2000 pcs.







## FLEX CORNER

- Chimney strip made of polyvinyl chloride.
- Used as a finishing strip for the corners of the chimney and facades covered with natural slate.
- It provides an aesthetic finish to the chimney.



13,6 mm x 2,5 m



RAL: 8004;  
9005; 8019



10 pcs.



800 pcs.

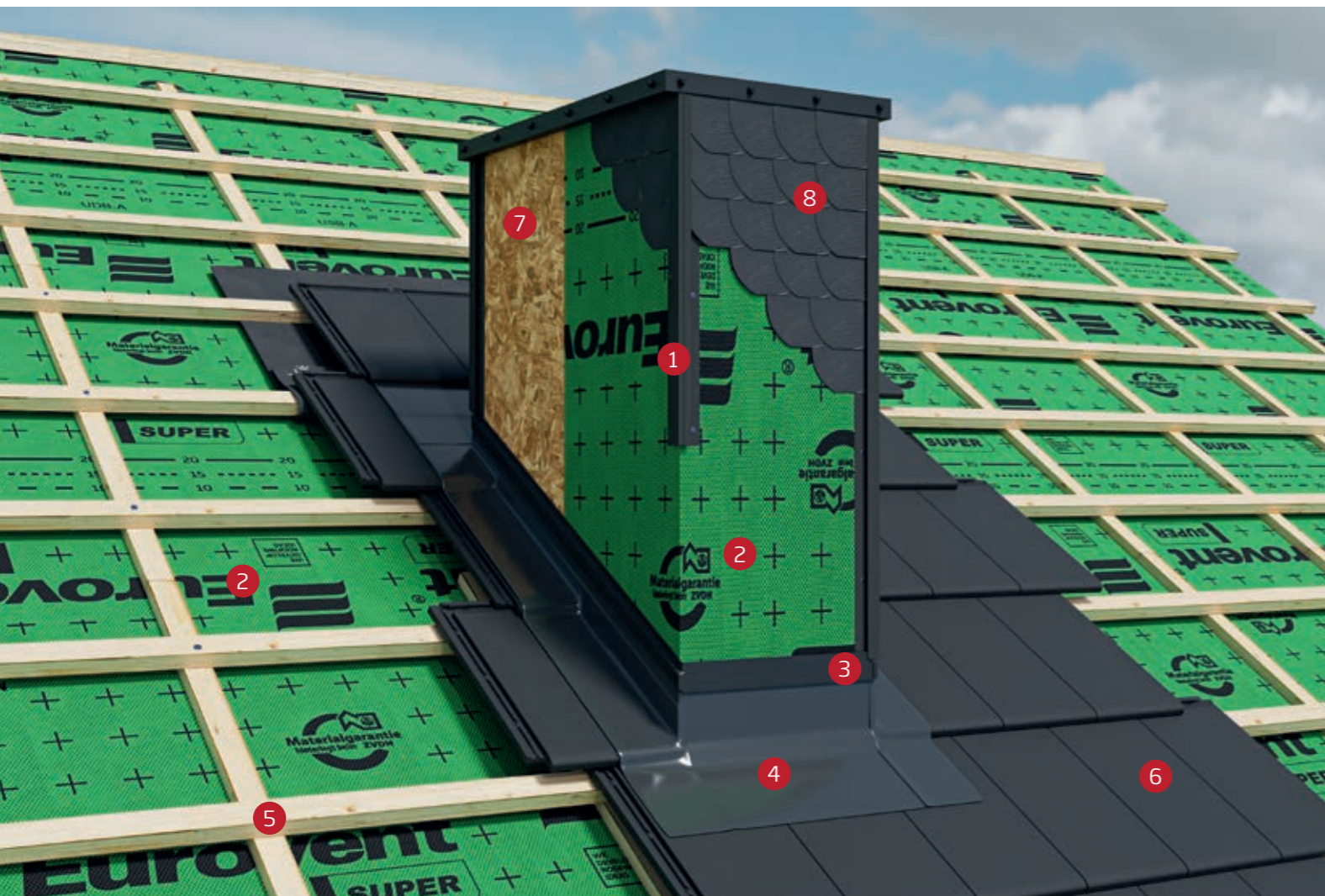

### › Application of a Eurovent® FLEX CORNER

- |                         |                          |              |                 |
|-------------------------|--------------------------|--------------|-----------------|
| 1 Eurovent® FLEX CORNER | 3 Eurovent® FLEX LINE    | 5 Batten     | 7 OSB board     |
| 2 Eurovent® SUPER       | 4 Eurovent® FLEX FLAT PB | 6 Roof cover | 8 Natural slate |



## › Clips

Clips for ceramic and concrete roof tiles installation enabling their tight arrangement and guaranteeing safe roof for long years.







## CLIP NORD-2

- Roof tile clip is made of hook-profiled steel wire on one side and tipped with rectangular plate crafted from galvanized steel tape.
- Fixed by nailing its sharp tip directly into the roof construction – then by fastening the plate to the side edge of the roof tile.



65 mm x 20 mm x 15 mm | 100 pcs. | 96 000 pcs.



## CLIP NORD-3

- Roof tile clip made of hook-profiled steel wire on one side and tipped with a half-round plate crafted from galvanized steel tape.
- Fixed by nailing its sharp tip directly into the roof construction – then by fastening the plate to the side edge of the roof tile.



65 mm x 20 mm x 15 mm | 100 pcs. | 90 000 pcs.

# Wind Zones

The Polish Standard PN-EN 1991-1-4 defines a division of load zones with the buildings construction wind. At present, there are no specific rules concerning the installation of roof tiles on a roof slope, for the reason of side and suction wind forces.



Based on the practical roofing art, the following recommendations have been adopted, as far as the installation of roof tiles with the use of clips is concerned.

Zone 1		Every 4 roof tiles
Zone 2		Every 3 roof tiles
Zone 3		Every 2 roof tiles

In case of a roof slope angle bigger than 55°, it is recommended to install every single roof tile with the use of a clip.

Independently on the wind zone, extreme, ridge, eaves roof tiles, as well as the ones around a chimney, roof windows and in valleys – must be installed with the use of clips.



## CLIP U

- Roof tile clip made of profiled galvanized steel wire
- Fixed by nailing its sharp tip directly into the roof construction and fastening the other tip to the edge of the roof tile.
- Firm and durable protection of roof tiles.

45 mm x 33 mm x 25 mm  
55 mm x 40 mm x 40 mm

100 pcs.

96 000 pcs.



## CLIP J

- Roof tile clip made of J-shaped galvanized steel wire for ceramic roof tiles installation.
- Fixed by fastening one of its tips to the side-lock or both to the side and top-locks, and its other tip to the batten.
- Firm and durable protection of roof tiles.



200 mm x 50 mm x 30 mm  
200 mm x 40 mm x 30 mm  
200 mm x 30 mm x 30 mm | 100 pcs. | 50 000 pcs.



## CLIP J2

- Roof tile clip made of J-shaped galvanized steel wire for ceramic roof tiles installation
- Fixed by fastening its tips to the side-locks of two neighboring roof tiles.
- Firm and durable protection of roof tiles.



320 mm x 15 mm x 15 mm | 100 pcs. | 12 000 pcs.





## CLIP DC-6

- Universal roof tile clip made of galvanized steel wire for ceramic roof tiles installation.
- Fixed by fastening one of its tips to the side-lock or both, side and top-locks.
- Firm and durable protection of roof tiles.



200 mm x 40 mm x 40 mm | 100 pcs. | 50 000 pcs.



## CLIP DC-9

- Universal side-clip made of galvanized steel wire for cement and ceramic roof tiles installation.
- Fixed by nailing its sharp tip directly into the roof construction and fastening the profiled tip to the side-lock of the roof tile.



65 mm x 48 mm;  
75 mm x 48 mm;  
85 mm x 65 mm;  
75 mm x 65 mm; | 100 pcs. | 32 000 pcs.



## CLIP BIBER

- Roof tile clip made of steel galvanized tape for fastening beaver-tail ceramic roof tiles.
- Firm and durable protection of roof tiles.
- Fixed by fastening one of its tips to the side-edge of the roof tile and the other tip to the batten.



42 mm x 90 mm x 64 mm | 100 pcs. | 4 500 pcs.



## CLIP C

- Roof tile clip for use with cut roof tiles.
- Manufactured of a steel wire and a metal bracket made of stainless steel.
- Fixed by mounting the metal bracket to the edge of the cut roof tile and fastening the steel wire to the nail in the roof structure.



20 mm x 30 mm x 400 mm | 25 pcs. | 16 000 pcs.



## > Eaves

Ventilating elements for the slope roof eaves and ventilating slots protecting against birds, rodents and drifted leaves.



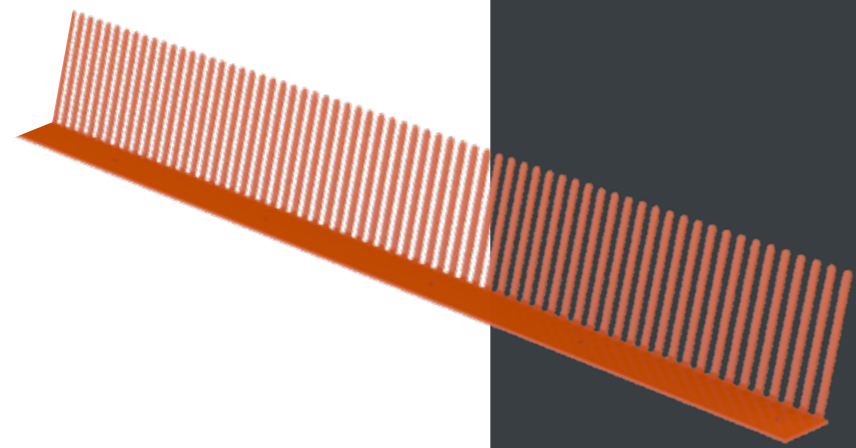



## COMB X

- Eaves COMB X is made of plastic. Used in sloping roofs as a ventilating element in the roof areas.
- Prevents against penetration of birds, insects, rodents and wind-driven leaves.

 60 mm; 80 mm; 100 mm x 1 rm

 60 mm: 300 pcs.;  
other: 50 pcs.

 RAL: 8004; 8019; 9005

 60 mm: 6 000 pcs.  
80 mm: 4 000 pcs.  
100 mm: 2 100 pcs.

### › Eaves protection

- 1 Eurovent® COMB VENTI
- 2 Eurovent® BUTYL
- 3 Eurovent® EAVES PLANK
- 4 Eurovent® EAVES GRATE
- 5 Eurovent® MAXI
- 6 Rafter
- 7 Counter batten
- 8 Eaves board
- 9 Roof tile
- 10 Guttering



## COMB VENTI

- Eaves COMB with a venting grate, manufactured from plastic. Used for sloping roofs as a ventilating element of the roof area.
- Prevents against penetration of birds, insects, rodents and wind-driven leaves.

 85 mm x 1 rm  RAL: 8004; 8019; 9005

 50 pcs.

 1 000 pcs.



## GRATE VENTI

- Ventilating eaves grate. Made from high quality plastic. Used for sloping roofs as a ventilating element of the roof area.
- Prevents against penetration of birds, insects, rodents and wind-driven leaves.

 32 mm x 1 rm  RAL: 8004; 8019; 9005

 100 pcs.

 1 000 pcs.

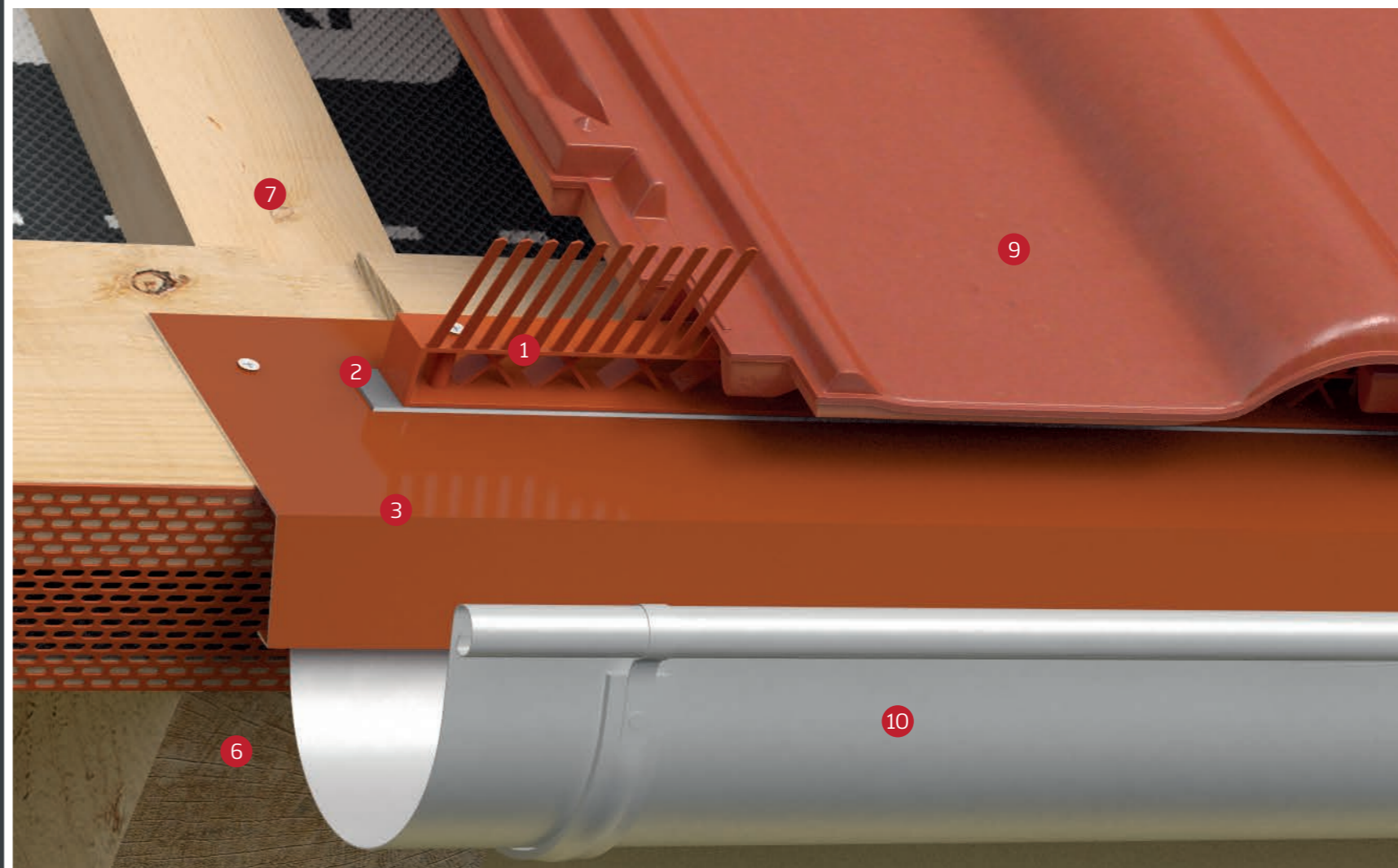
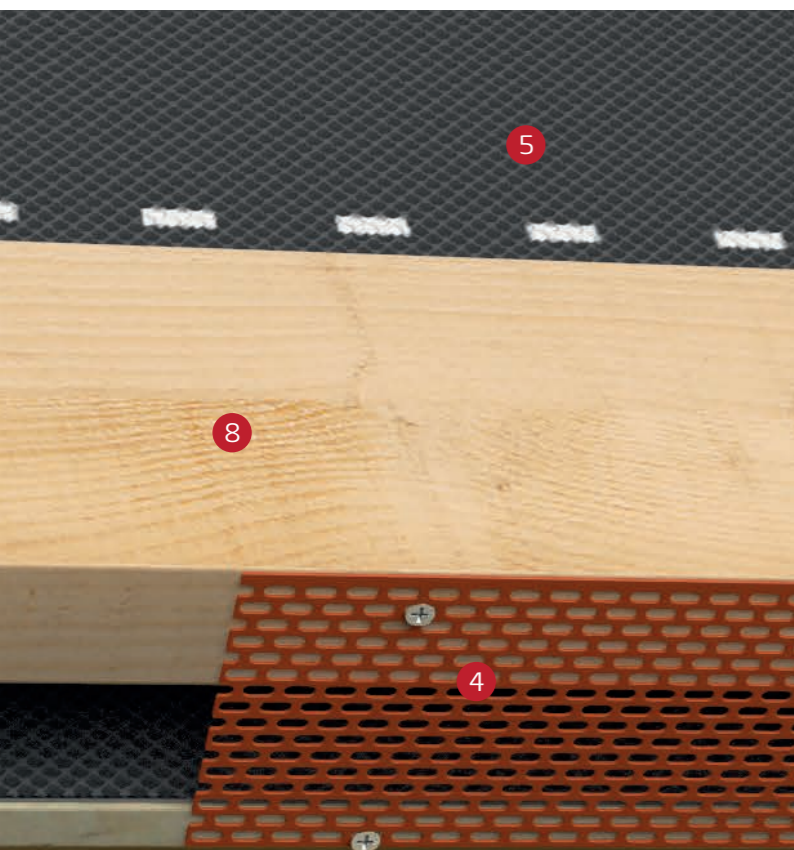







## EAVES GRATE

- Eaves grate manufactured from plastics.
- Protects the eaves area and other ventilation intakes in a building elevation against penetration of birds, insects, rodents and wind-driven leaves.

 50 mm; 80 mm;  
 100 mm x 5 mm  
 BOX: 60 mm
  RAL: 8004; 8019; 9005

 50 mm: 48 rolls  
 other: 24 rolls  
 BOX: 1 roll
  50 mm: 1440 rolls  
 80; 100 mm: 840 rolls  
 BOX: 54 rolls

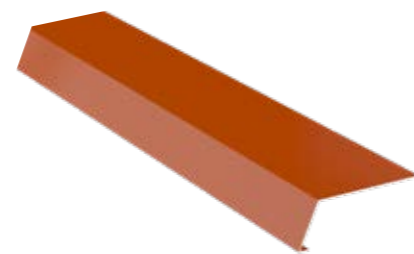

## EAVES PLANK

- Overgutter plank manufactured from aluminum sheet, coated with polyester paint, additionally protected by polyethylene foil, that is removed in the installation process.
- Reinforces and protects the eaves area where rainwater is drained to the gutter system.



 45 mm x 110 mm  
 x 2 mm; 70 mm x  
 120 mm x 2mm
  RAL: 8004; 8019; 8017;  
 9005; 7021; 8015; 3011

 20 pcs.
  800 pcs.



## EAVES GRATE ALU

- Eaves grate manufactured from aluminum
- Protects the eaves area and other ventilation intakes in a building elevation against penetration of birds, insects, rodents and wind-driven leaves.

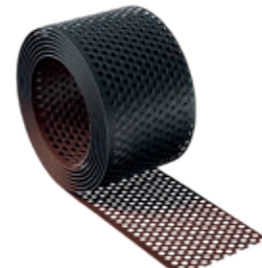

 100 mm x 60 mm
  Aluminum

 1 roll
  54 rolls



## EAVES GRATE RAL

- Eaves grate manufactured from aluminum
- Double colour RAL 7016 and RAL 8017
- Protects the eaves area and other ventilation intakes in a building elevation against penetration of birds, insects, rodents and wind-driven leaves.

 100 mm x 25 mm
  RAL 7016/8017

 1 roll
  80 rolls



## › Tapes and adhesives

Self-adhesive tapes and adhesives for gluing as well as sealing roof membranes, vapour-barrier foils and building materials based on plastics, too.





## BUTYL

- Double-sided, solvent-free tape, made on the basis of butyl, with a separating silicon paper layer.
- Used for joining and sealing vapour-barrier, roof and foundation foils and other construction products based on plastics.

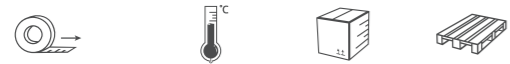

15 mm x 25 m | > 5°C | 16 rolls | 480 rolls



## BUTYL PRO

- Double-sided, solvent-free tape.
- Used as sealing tape under battens as well as for joining and sealing vapour-barrier foils, roof membranes and wind-barrier membranes in frame construction.

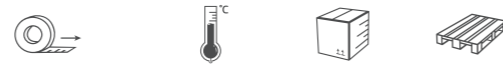

45 mm x 20 m | > 5°C | 8 rolls | 240 rolls



## DUO

- Double-sided tape made of polyester mesh, coated on both sides with special adhesive based on acrylic dispersion
- Used for joining vapour-barrier foils, roof membranes and other construction products based on plastics.



20 mm x 25 m | > 5°C | 14 rolls | 1680 rolls  
50 mm x 25 m | 6 rolls | 720 rolls



## PUR

- One-sided sealing tape, made of polyethylene foam with closed cells structure and coated on one side with adhesive based on acrylic dispersion.
- Recommended for sealing and isolation of roof and building constructions.

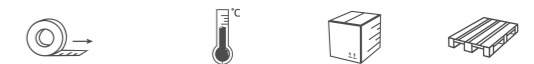

40 mm x 25 m | > 5°C | 24 rolls | 288 rolls

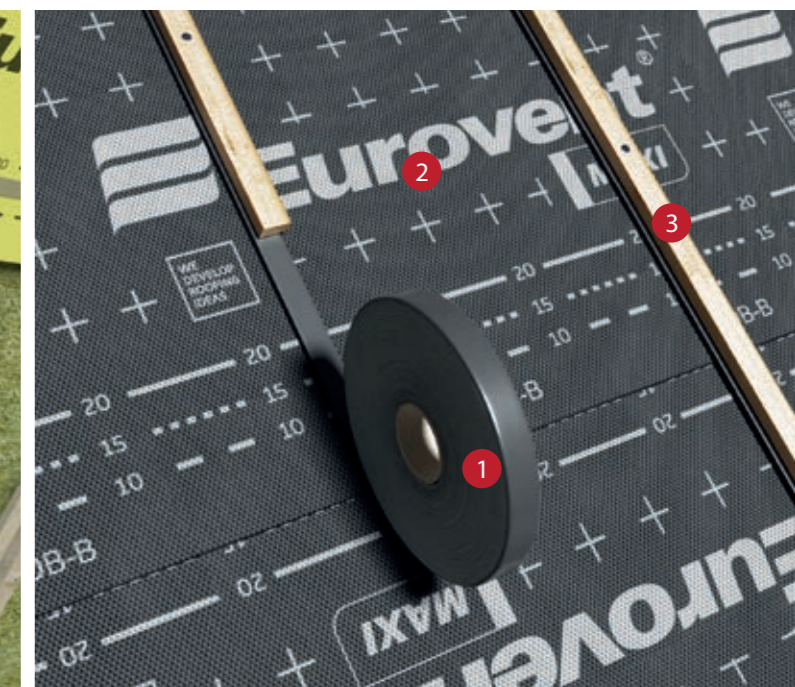
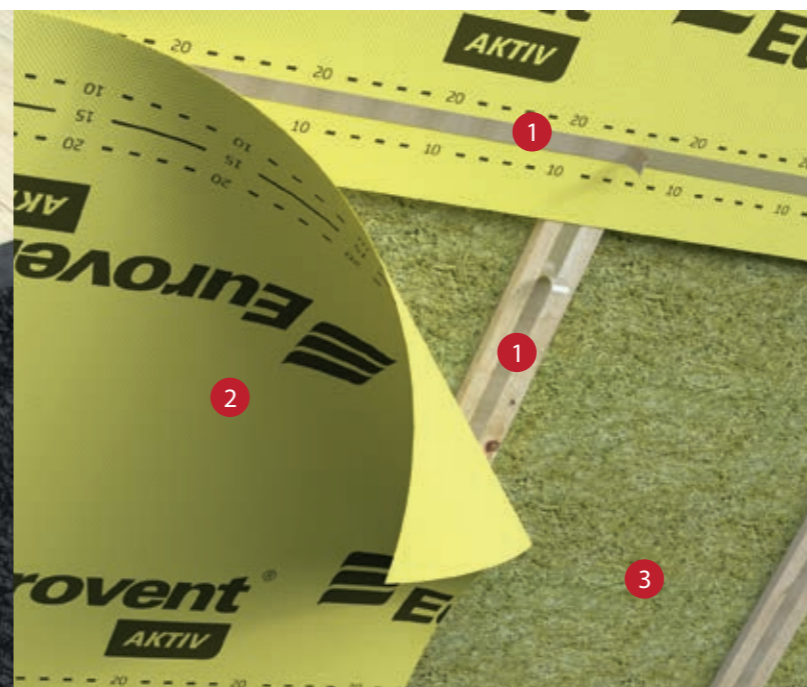
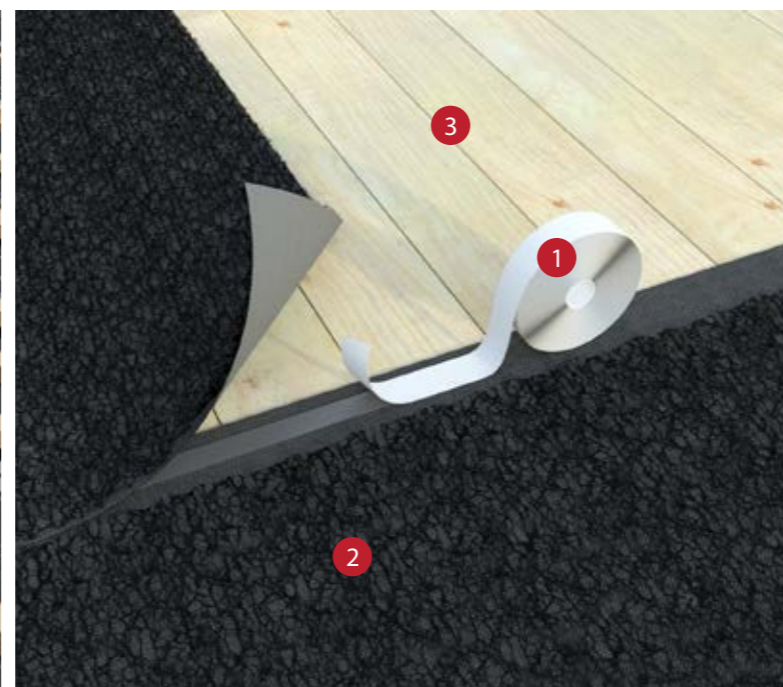
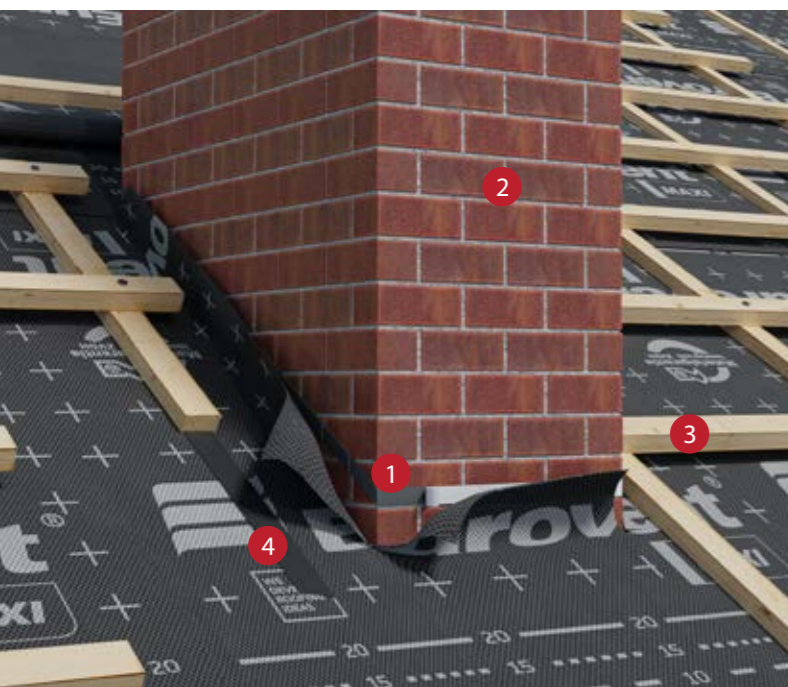

### › Application of Eurovent® BUTYL

- 1 Eurovent® BUTYL
- 2 Chimney
- 3 Batten
- 4 Eurovent® PUR

### › Application of Eurovent® BUTYL PRO

- 1 Eurovent® BUTYL PRO
- 2 Eurovent® METALLIC
- 3 Full Sheathing

### › Application of Eurovent® DUO

- 1 Eurovent® DUO
- 2 Eurovent® AKTIV
- 3 Thermal insulation

### › Application of Eurovent® PUR

- 1 Eurovent® PUR
- 2 Eurovent® MAXI
- 3 Counter batten



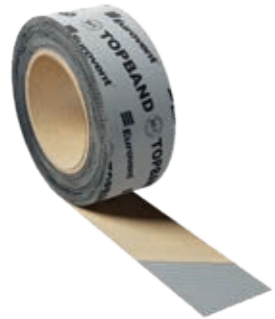

## TOPBAND

- One-sided sealing tape made of polypropylene nonwoven and acrylic dispersion adhesive.
- Used for sealing and repairing roof membranes, wind insulation and other polypropylene-based products.



50 mm x 25 rm

> 5°C

12 rolls

720 rolls

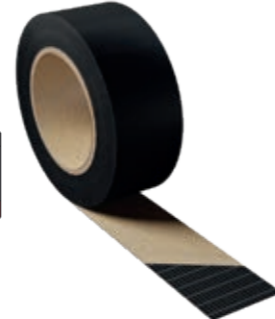

## UNO COLD UV

- Single-sided, tape made of PE mesh, reinforced with polyester fiber and special acrylic dispersion adhesive.
- Used for sealing plastic materials based on polypropylene and polyethylene. Dedicated especially for application in minus temperatures.



50 mm x 25 rm

12 months

- 10°C

12 rolls

720 rolls

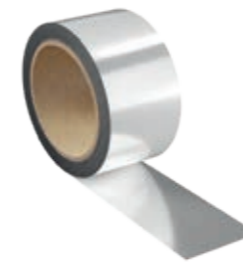

## ALUFIX

- Single-sided metallized tape made of PE foil and special adhesive based on acrylic dispersion.
- Used for sealing and repairing foils and vapour-barrier membranes on the basis of aluminum and metallized surfaces.



50 mm x 50 rm;  
75 mm x 50 rm

> 5°C

36 rolls;  
24 rolls

2 592 rolls;  
2 304 rolls



## HYDRAL

- Single-sided assembly tape made of waterproof paper and a special glue based on acrylic dispersion, solvent-free and chlorine - free.
- Used for gluing and repairing foils and vapour-barrier membranes as well as for sealing joints of wood-based materials and plaster boards.



60 mm x 40 rm

> 5°C

10 rolls

600 rolls



### › Application of Eurovent® TOPBAND

- 1 Eurovent® TOPBAND
- 2 Eurovent® SUPER
- 3 Full Sheathing



### › Application of Eurovent® UNO COLD UV

- 1 Eurovent® UNO COLD UV
- 2 Eurovent® FASSADE
- 3 Facade



### › Application of Eurovent® ALUFIX

- 1 Eurovent® ALUFIX
- 2 Eurovent® STANDARD ALU
- 3 Plasterboard



### › Application of Eurovent® HYDRAL

- 1 Eurovent® HYDRAL
- 2 OSB board
- 3 Wall





## UNO

- Universal, single-sided tape made of PE foil, reinforced with polyester fiber and special acrylic dispersion adhesive.
- Used for sealing and repairing foils and membranes made of plastic as well as for joining them with wood and metallized elements.



50 mm x 25 mm

> 5°C

12 rolls

720 rolls



## UNISAN

- Universal, single-sided tape made of PE mesh, reinforced with polyester fiber and special acrylic dispersion adhesive.
- Used in construction, for bonding and repairing vapour-barrier foils as well as roofing membranes, for fixing installation damages.



60 mm x 25 mm  
120 mm x 25 mm

> 5°C

10 rolls  
4 rolls

600 rolls  
240 rolls



## MULTI

- Highly adhesive, solvent-free and odourless general purpose adhesive, ideal for sealing vapour-barrier and buildings interiors. Strongly resistant to aging.
- Flexible and stretchable, susceptible to building movements - dilatation sealing.
- Suitable for plastering.



310 ml

from -10°C  
to +40°C

20 pcs.

1200 pcs.



DIN 18542  
According to



## COMPRE X

- Single-sided expandable tape made of flexible polyurethane foam soaked in modified acrylic.
- For sealing slots and joints in roof and general construction works. Recommended for application in the areas of ridge, valley and roof windows.
- Effectively seals slots along roof valleys to protect the roof against penetration of moisture, wind, rain and cold.



15/30 x 6 mm; 15/40 x 8 mm;  
15/50 x 4,3 mm

> 5°C

32 rolls  
24 rolls

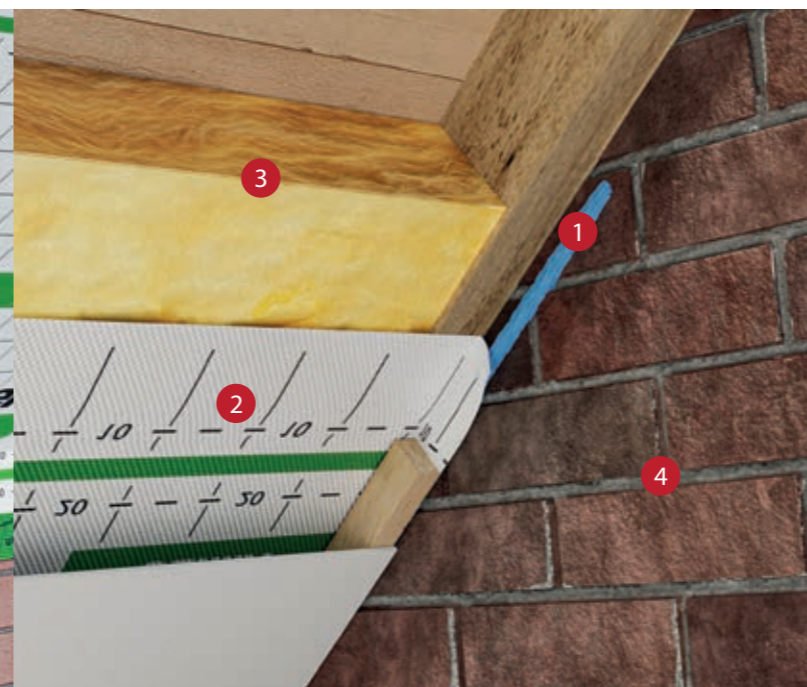
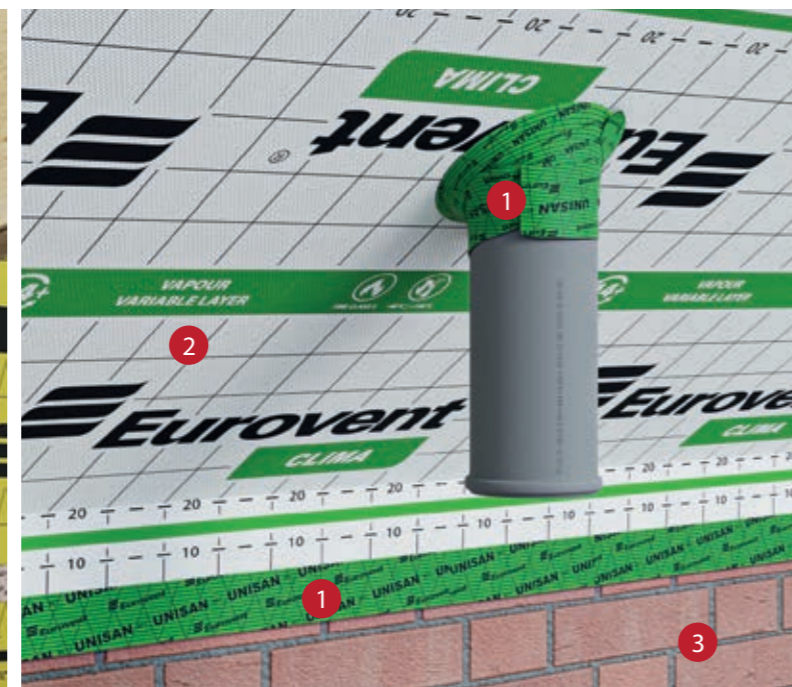

### › Application of Eurovent® UNO

- 1 Eurovent® UNO
- 2 Eurovent® AKTIV
- 3 Construction

### › Application of Eurovent® UNISAN

- 1 Eurovent® UNISAN
- 2 Eurovent® CLIMA
- 3 Wall

### › Application of Eurovent® MULTI

- 1 Eurovent® MULTI
- 2 Eurovent® CLIMA
- 3 Thermal insulation
- 4 Wall

### › Application of Eurovent® COMPRE X

- 1 Eurovent® COMPRE X
- 2 Eurovent® VALLEY
- 3 Eurovent® SUPER





**Eurovent® THERMO 3**

It is an efficient system of tapes and sealings suitable for the installation of window and doors in the so called "Warm Installation" technology.

**Eurovent® THERMO 3**

Reduces the costs of energy consumption, prevents cold bridges development, dedicated for window joinery in modern, passive, frame construction as well as in case of modernisation of the buildings already existing.

**Eurovent® THERMO 3**

Insulates thermally and accoustically, durably protects against moisture as well as fungus and mould appearance in the areas of windows and doors. Ensures healthy climate in buildings.



Increase thermal conductivity



Elimination of mold and fungi.



Acoustic insulation.



Elimination of thermal bridges.



Protection against water and moisture.

# ASSEMBLY - THERMO 3

**SINGLE-LAYER WALL.**

- 1 Eurovent® AKTIVBAND SK2
- 2 Montage foam or Eurovent® COMPRE 600
- 3 Eurovent® COMPRE 600
- 4 Wall
- 5 Jamb
- 6 Plaster
- 7 Window

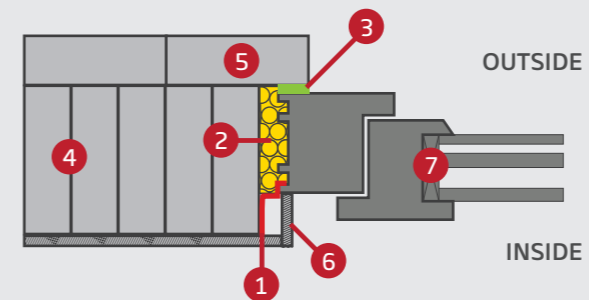

**DOUBLE-LAYER WALL.**

- 1 Eurovent® AKTIVBAND SK2
- 2 Montage foam or Eurovent® COMPRE 600
- 3 Eurovent® DIFFUBAND SK2
- 4 Eurovent® COMPRE 600
- 5 Wall
- 6 Thermal insulation
- 7 Plaster, facade
- 8 Window

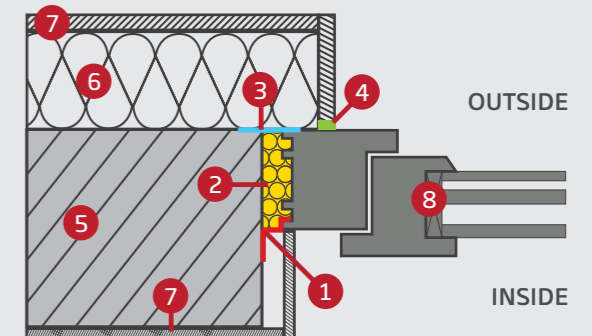

**TIMBER FRAME WALL.**

- 1 Eurovent® COMPRE 600
- 2 Eurovent® AKTIVBAND SK
- 3 Timber frame
- 4 Thermal insulation
- 5 Facade
- 6 Plasterboard
- 7 Window

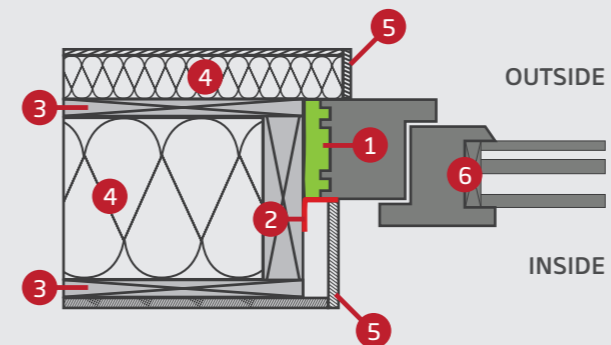

**MULTI-LAYER WALL.**

- 1 Eurovent® COMPRE 3W
- 2 Thermal insulation
- 3 Plaster
- 4 Clinker brick
- 5 Window
- 6 Wall

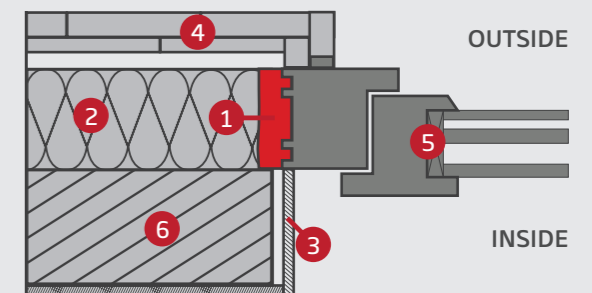





# WINDOW TAPES

Airtight window tapes and expanding tapes for the installation of windows, doors and gates in layered technique "Warm Installation"

## › Application of window tapes

- 1 Eurovent® AKTIVBAND SK
- 2 Eurovent® DIFFUBAND SK
- 3 Thermal insulating
- 4 Outer wall
- 5 Windowsill
- 6 PVC Window
- 7 Glass
- 8 Montage foam

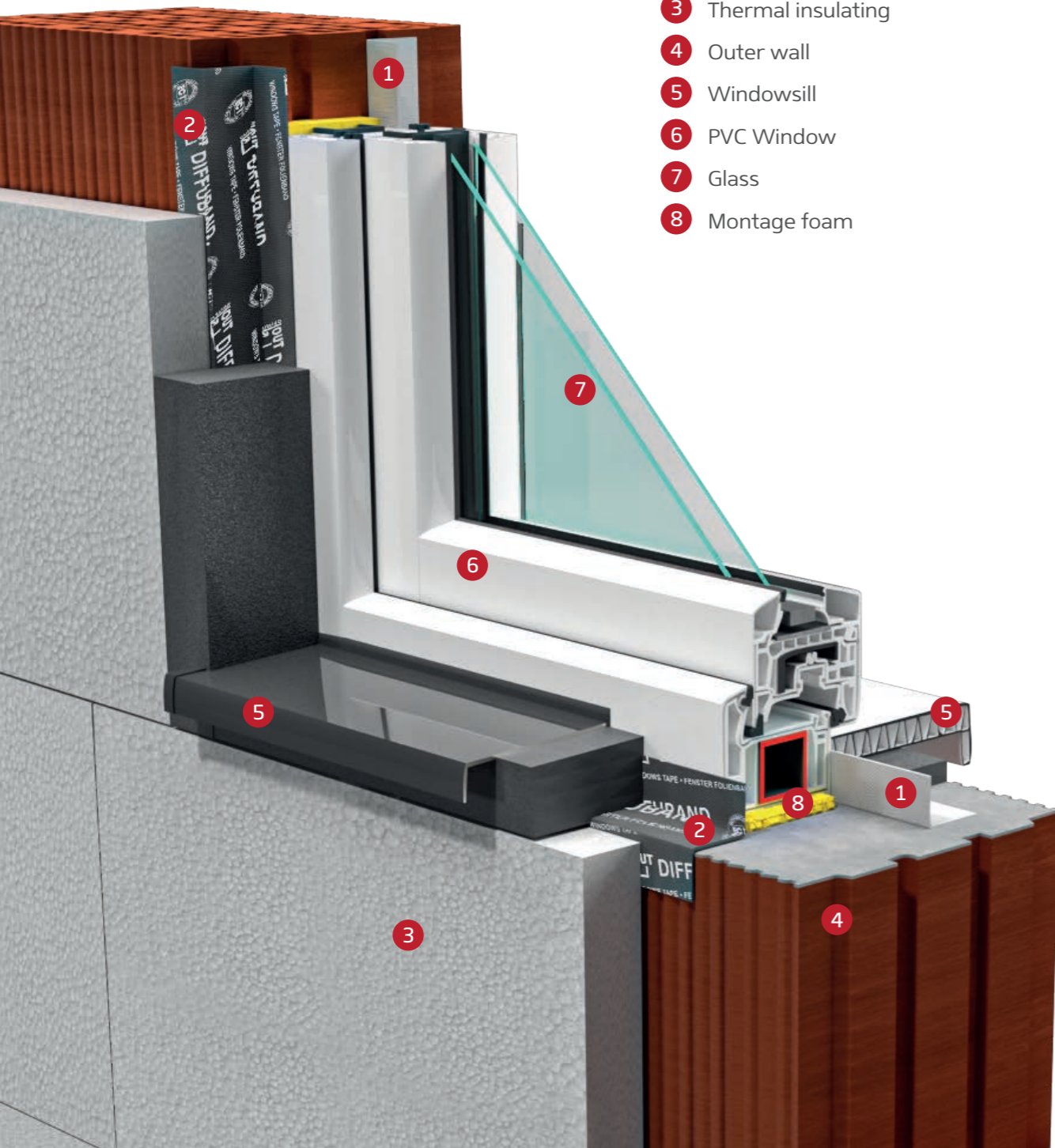

## AKTIVBAND SK

- Interior vapour-barrier window tape AKTIVBAND SK suitable for the insulation of window mounting holes, blinds and doors in the so called "Warm Installation" technology.
- Made from special nonwoven fabric as well as vapour-barrier film, coated on one side with a layer of adhesive on the whole surface which facilitates its application to the window frame and to the wall.
- Does not require extra adhesive or preparation for grounds priming.

70 mm x 25 rm; 100 mm x 25 rm; 150 mm x 25 rm*	> 5°C	8 roll; 6 roll; 1 roll	384 rolls; 288 rolls; 240 rolls

## AKTIVBAND SK2

- Interior vapour-barrier window tape AKTIVBAND SK2 suitable for the insulation of window mounting holes, blinds and doors in the so called "Warm Installation" technology.
- Made from special nonwoven fabric as well as vapour-barrier film, coated on one side with a layer of adhesive on the whole surface.
- Equipped with an adhesive stripe 20 mm (SK2) on the other side which facilitates its application to the window frame and to the wall.
- Does not require extra adhesive or preparation for grounds priming.

70 mm x 25 rm; 100 mm x 25 rm; 150 mm x 25 rm*	> 5°C	8 roll; 6 roll; 1 roll	384 rolls; 288 rolls; 240 rolls

## › Composition of Eurovent® AKTIVBAND SK Eurovent® AKTIVBAND SK2

- 1 Silicon paper layer
- 2 Special acrylic adhesive layer - SK
- 3 Nonwoven fabric with functional film.
- 4 Additional adhesive strip - SK2



\* on order





## DIFFUBAND SK

- Exterior vapour-permeable window tape DIFFUBAND SK suitable for the insulation of window mounting holes, blinds and doors in the so called "Warm Installation" technology.
- Made from special nonwoven fabric, coated on one side with a layer of adhesive on the whole surface which facilitates its application to the window frame and to the wall.
- Does not require extra adhesive or preparation for grounds priming.



70 mm x 25 rm;  
100 mm x 25 rm;  
150 mm x 25 rm\*

> 5°C

8 roll;  
6 roll;  
1 roll

384 rolls;  
288 rolls;  
240 rolls

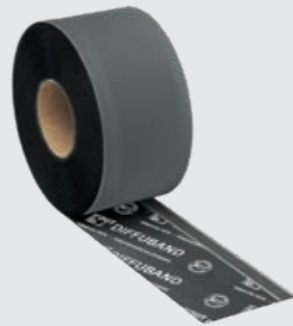

## DIFFUBAND SK2

- Exterior vapour-permeable window tape DIFFUBAND SK2 suitable for the insulation of window mounting holes, blinds and doors in the so called "Warm Installation" technology.
- Made from special nonwoven fabric, coated on one side with a layer of adhesive on the whole surface.
- Equipped with an adhesive stripe 20 mm (SK2) on the other side which facilitates its application to the window frame and to the wall.
- Does not require extra adhesive or preparation for grounds priming.



70 mm x 25 rm;  
100 mm x 25 rm;  
150 mm x 25 rm\*

> 5°C

8 roll;  
6 roll;  
1 roll

384 rolls;  
288 rolls;  
240 rolls

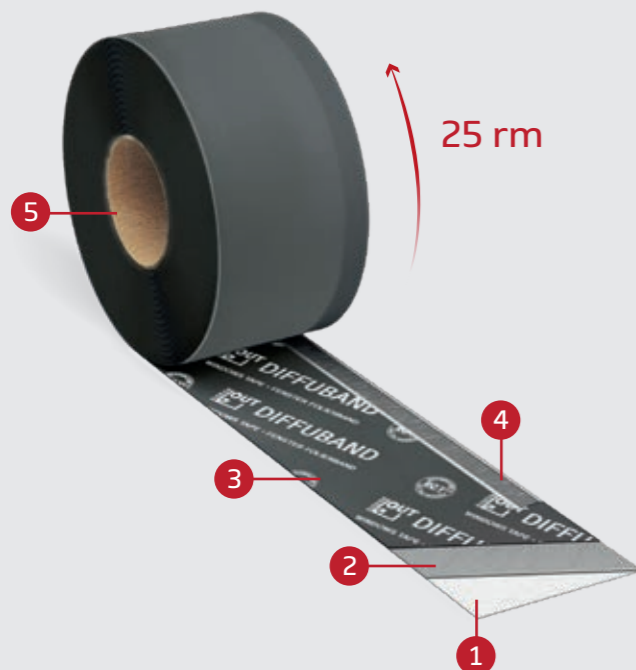

### > Composition of Eurovent® DIFFUBAND SK Eurovent® DIFFUBAND SK2

- 1 Silicon paper layer
- 2 Special acrylic adhesive layer - SK
- 3 Nonwoven fabric
- 4 Additional adhesive strip SK2
- 5 Roll

\* on order







DIN 18542  
According to



## COMPRE 300

- Expanding tape made of flexible polyurethane foam soaked with modified acrylic.
- Flammability class B2. Sealing class  $\geq 300$  hPa.
- Suitable for the installation of windows, doors and garage doors. Moreover, for sealing holes, cracks and grouts in roofs, windows and elevations
- It is recommended to protect it against long lasting activity of atmospheric factors.
- Especially recommended for the insulation of grouts in constructions with a jamb.
- Insulates against moisture, wind, rain, cold and acoustically.

Tape	Width	Slit size	Roll length	Box
10/2-3	10	2-3	12,5	48
15/2-3	15	2-3	12,5	32
20/2-3	20	2-3	12,5	24
15/3-6	15	3-6	10	32
20/3-6	20	3-6	10	24
15/4-8	15	4-8	8	32
20/4-8	20	4-8	8	24
15/5-10	15	5-10	8	32
20/5-10	20	5-10	8	24
15/7-12	15	7-12	6	32
20/7-12	20	7-12	6	24
25/7-12	25	7-12	6	19
30/7-12	30	7-12	6	16
20/9-15	20	9-15	4,3	19
25/9-15	25	9-15	4,3	19
30/9-15	30	9-15	4,3	16
40/10-18	40	10-18	4	18
30/14-24	30	14-24	4	16
40/14-24	40	14-24	4	12



> 5°C



$\geq 300$  hPa



DIN 18542  
According to



## COMPRE 600

- Expanding tape made of flexible polyurethane foam soaked with modified acrylic.
- Flammability class B1. Sealing class  $\geq 600$  hPa.
- Suitable for the installation of windows, doors and garage doors as well as for technical sealings in elevations, windows, doors and roofs.
- Resistant to heavy rains as well as to UV radiation, does not require protection against the activity of atmospheric factors.
- Insulates against moisture, wind, rain, cold and acoustically.
- Especially recommended for frame construction, passive houses and for constructions with a jamb.

Tape	Width	Slit size	Roll length	Box
15/7-12	15	7-12	8	32
20/7-12	20	7-12	8	24
30/7-12	30	7-12	8	16
20/9-15	20	9-15	4,3	24
25/9-15	25	9-15	4,3	19
30/9-15	30	9-15	4,3	16
35/18-32	35	18-32	2	14
40/24-40	40	24-40	2	12
50/24-40	50	24-40	2	9



> 5°C



$\geq 600$  hPa

## Eurovent® COMPRE 600

Used as waterproof and windproof sealings in prefabricated elements built from concrete, metal and wood, clinker facades, as a joining of shutterings, or a sealing of outer joints. It is also suitable as an insulation of slits by window, door joinery, as well as in constructions with jamb. The tape in class > 600 hPa does not require to be covered after its installation, as it is completely resistant to long-lasting UV radiation.

### > Insulation of wood log slits

- 1 Eurovent® COMPRE 600
- 2 Wood log
- 3 Eurovent® WALL PROTECT 3

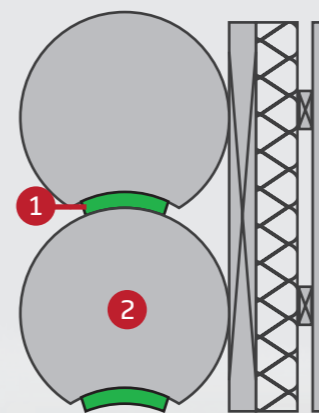

### > Insulation of slits in facades

- 1 Eurovent® COMPRE 600
- 2 Elevation
- 3 Wall

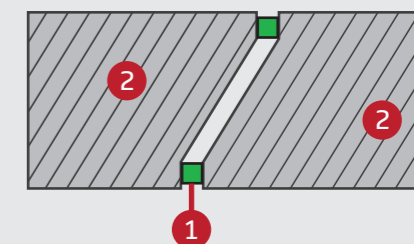



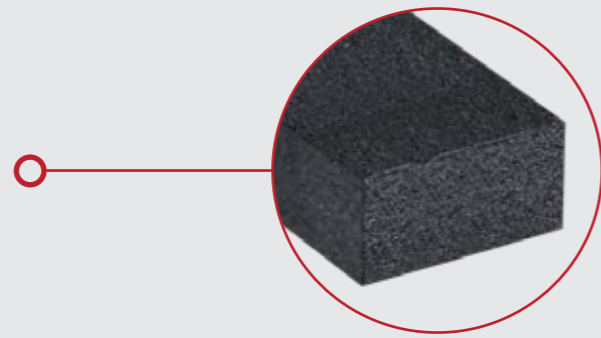



## COMPRE 3W

- Multifunctional expanding tape made of flexible polyurethane foam soaked with synthetic resin.
- Flammability class B1. Sealing class  $\geq 600$  hPa.
- Resistant to atmospheric factors and UV radiation.
- Dedicated for the installation of windows, doors and garage doors as well as for sealings of grouts and installation cracks.
- Ensures thermal and acoustic insulation, insulates against moisture, wind and rain.
- Replaces installation foam and window tapes when installing windows, doors and garage doors too.



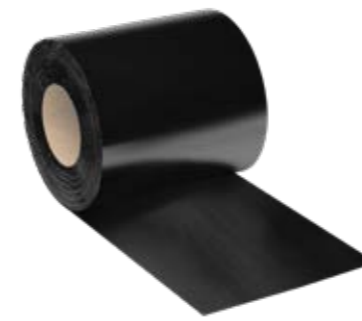
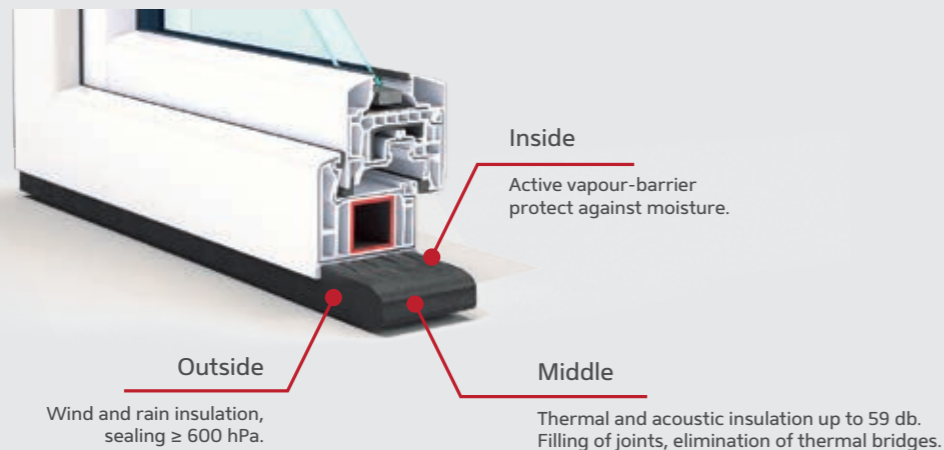

 from -30°C up to +80°C  
  $\geq 600$  hPa  
 64/ - 7 rolls  
 74/ - 6 rolls;  
 84/ - 5 rolls

Tape	Window frame	Tape width	Slit size	Roll length
64/5-10	70	64	5-10	8
74/5-10	80	74	5-10	8
84/5-10	90	84	5-10	8
64/10-20	70	64	10-20	6
74/10-20	80	74	10-20	6
84/10-20	90	84	10-20	6



## EPDM PRO

- External sealing tape from synthetic rubber of a structure increasing adhesiveness.
- Used for outer vertical and horizontal damp-proof insulation as well as for sealing connections between doors, windows, windowsills, elevation and a building construction.
- Recommended for insulation of terraces and balconies areas.
- Indispensable by warm installation of window and aluminium joinery. Available with an extra butyl strip on order.

 EPDM - 0,75 mm; EPDM - 1,1 mm\*  
 -30°C to +100°C  
 50 mm x 25 m;  
 60 mm x 25 m;  
 100 mm x 25 m;  
 110 mm x 25 m;  
 130 mm x 25 m;  
 150 mm x 25 m;  
 200 mm x 25 m;  
 250 mm x 25 m;  
 300 mm x 25 m;  
 400 mm x 25 m;  
 500 mm x 25 m  
 60 mm: 5 rolls  
 50; 100; 150; 200 mm: 4 rolls  
 other: 2 rolls

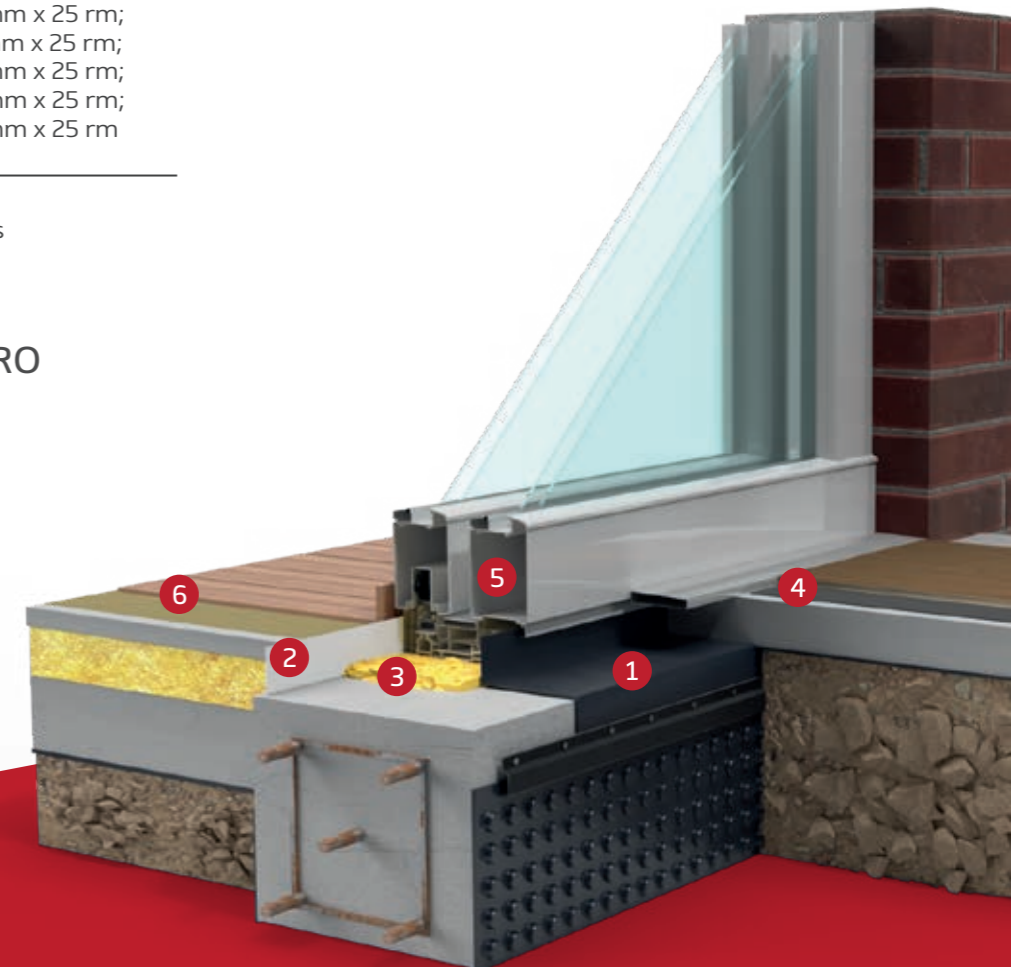

### Application of EPDM PRO

- 1 Eurovent® EPDM PRO
- 2 Eurovent® AKTIVBAND SK
- 3 Montage foam
- 4 Terrace
- 5 Terrace window
- 6 Floor inside



## CORNER PRO

- Sealing coign is used as a sealing element of a membrane and foil joinings in doors and windows coignes.
- Recommended for frame and module constructions, as a complementary element of insulating systems.

 100 mm x 120 mm;  
 160 mm x 120 mm  
 -30°C to +100°C  
 50 pcs.



# APPLICATION OF SEALING TAPES

## THE USE ACCORDING TO THE TYPE OF THE SUBSTRATES

- Recommended application
- Application under condition\*
- Not recommended application

\* it is not recommended to apply on a brick substrate

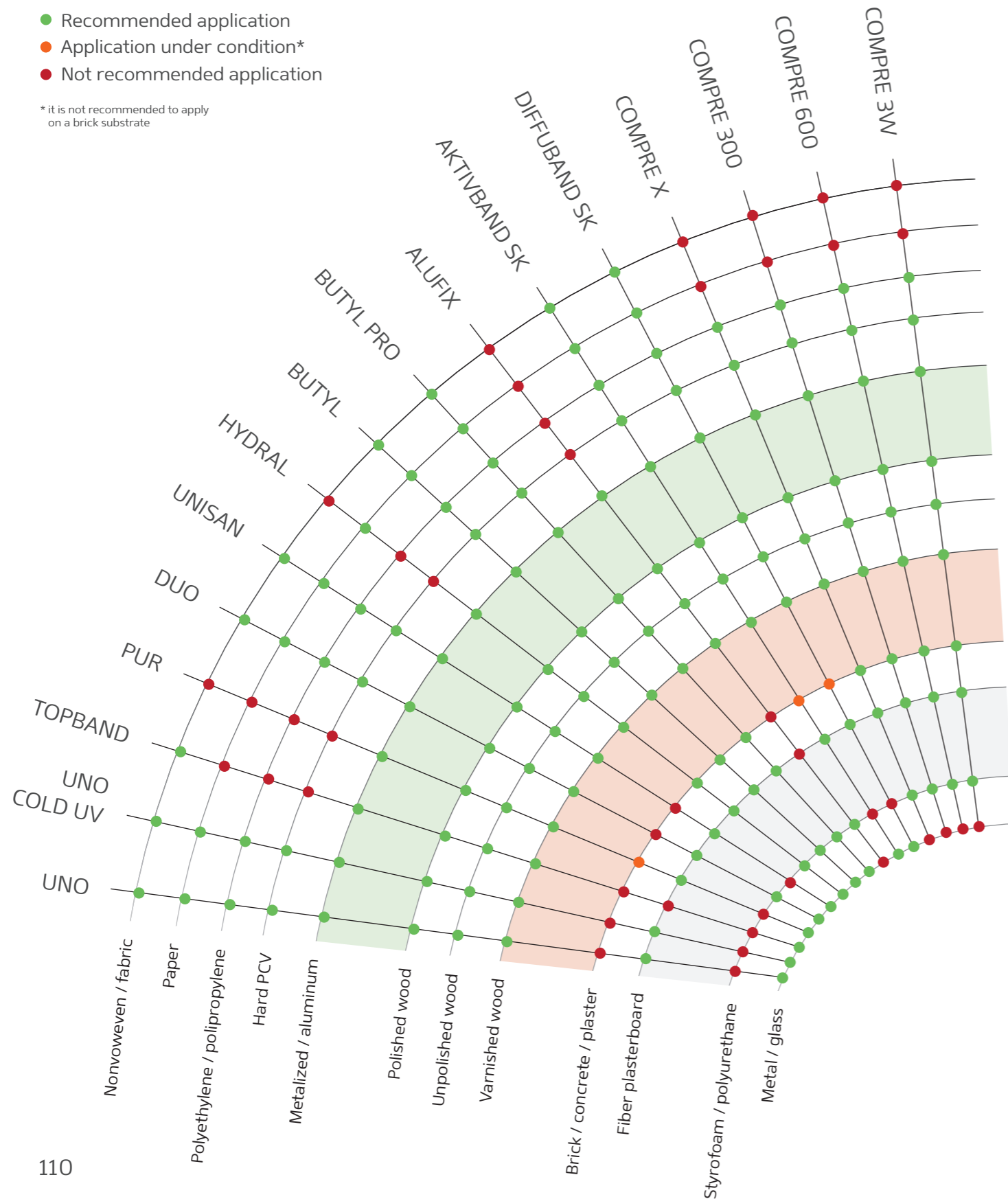

## THE USE ACCORDING TO THE APPLICATION AREA

- Recommended application
- Not recommended application

	UNO	UNO COLD UV	TOPBAND	PUR	DUO	UNISAN	HYDRAL	BUTYL	BUTYL PRO	ALUFIX	AKTIVBAND SK	DIFUBAND SK	COMPRE 300	COMPRE 600	COMPRE 300	COMPRE 600
inside building	●	●	●	●	●	●	●	●	●	●	●	●	●	●	●	●
outside building	●	●	●	●	●	●	●	●	●	●	●	●	●	●	●	●
roof with a slope > 15°	●	●	●	●	●	●	●	●	●	●	●	●	●	●	●	●
roof with a slope < 15°	●	●	●	●	●	●	●	●	●	●	●	●	●	●	●	●
sealing roof membranes	●	●	●	●	●	●	●	●	●	●	●	●	●	●	●	●
repairing roof membranes	●	●	●	●	●	●	●	●	●	●	●	●	●	●	●	●
sealing insulating foils	●	●	●	●	●	●	●	●	●	●	●	●	●	●	●	●
repairing insulating foils	●	●	●	●	●	●	●	●	●	●	●	●	●	●	●	●
sealing nail punctures	●	●	●	●	●	●	●	●	●	●	●	●	●	●	●	●
through holes	●	●	●	●	●	●	●	●	●	●	●	●	●	●	●	●
application temperature >5°C	●	●	●	●	●	●	●	●	●	●	●	●	●	●	●	●
application temperature <5°C	●	●	●	●	●	●	●	●	●	●	●	●	●	●	●	●
uneven surface	●	●	●	●	●	●	●	●	●	●	●	●	●	●	●	●

## THE TYPES OF THE COLLARS

- Recommended application
- Application under condition\*
- Not recommended application

\* it is not recommended to apply on a brick substrate.

	outside building	inside building	cable sealing	pipes sealing	Styrofoam / polyurethane	Fiber plasterboard	Brick / concrete / plaster	Polished wood	Unpolished wood	Varnished wood	Metalized / aluminum	Hard PCV	Polyethylene / polypropylene	Paper	Nonwoven / fabric
MINISEAL	●	●	●	●	●	●	●	●	●	●	●	●	●	●	●
SEAL	●	●	●	●	●	●	●	●	●	●	●	●	●	●	●
MULTISEAL	●	●	●	●	●	●	●	●	●	●	●	●	●	●	●





# SEALING COLLAR

Sealing collar, called as sealing sleeves in other words, serve for durable sealing of cable, solar passages and pipes.



## SEAL



- Sealing collar used for solar connections and different pipe systems, e.g. for sealing heating, sewage, ventilation pipes that drain rainwater, etc.

	∅		
R1	15-22mm	150 x 150 mm	10 pcs.
R2	25-32 mm	150 x 150 mm	10 pcs.
R3	40-55 mm	230 x 230 mm	10 pcs.
R4	50-72 mm	230 x 230 mm	4 pcs.
R5	72-90 mm	230 x 230 mm	4 pcs.
R6	100-110 mm	320 x 320 mm	4 pcs.
R7	100-125 mm	350 x 350 mm	4 pcs.
R8	125-135 mm	320 x 320 mm	4 pcs.



## MINI SEAL



- Sealing collar used for cable connections of diameters 4-8 mm and 8-12 mm

	∅		
K1	4-8 mm	150 x 150 mm	10 pcs.
K2	8-12 mm	150 x 150 mm	10 pcs.



## MULTI SEAL

- Six-ducts sealing collar designed for quick cable connections sealing. Used for cables of diameter 4-11 mm and pipes of 8-12 mm diameter

	∅		
KM1	6 x 4-11 mm	230 x 230 mm	4 pcs.
RM2	6 x 16-25 mm	320 x 320 mm	4 pcs.



### › Application of the Eurovent® MULTI SEAL

- 1 Eurovent® MULTI SEAL
- 2 Eurovent® CLIMA
- 3 Cable bundles sheath



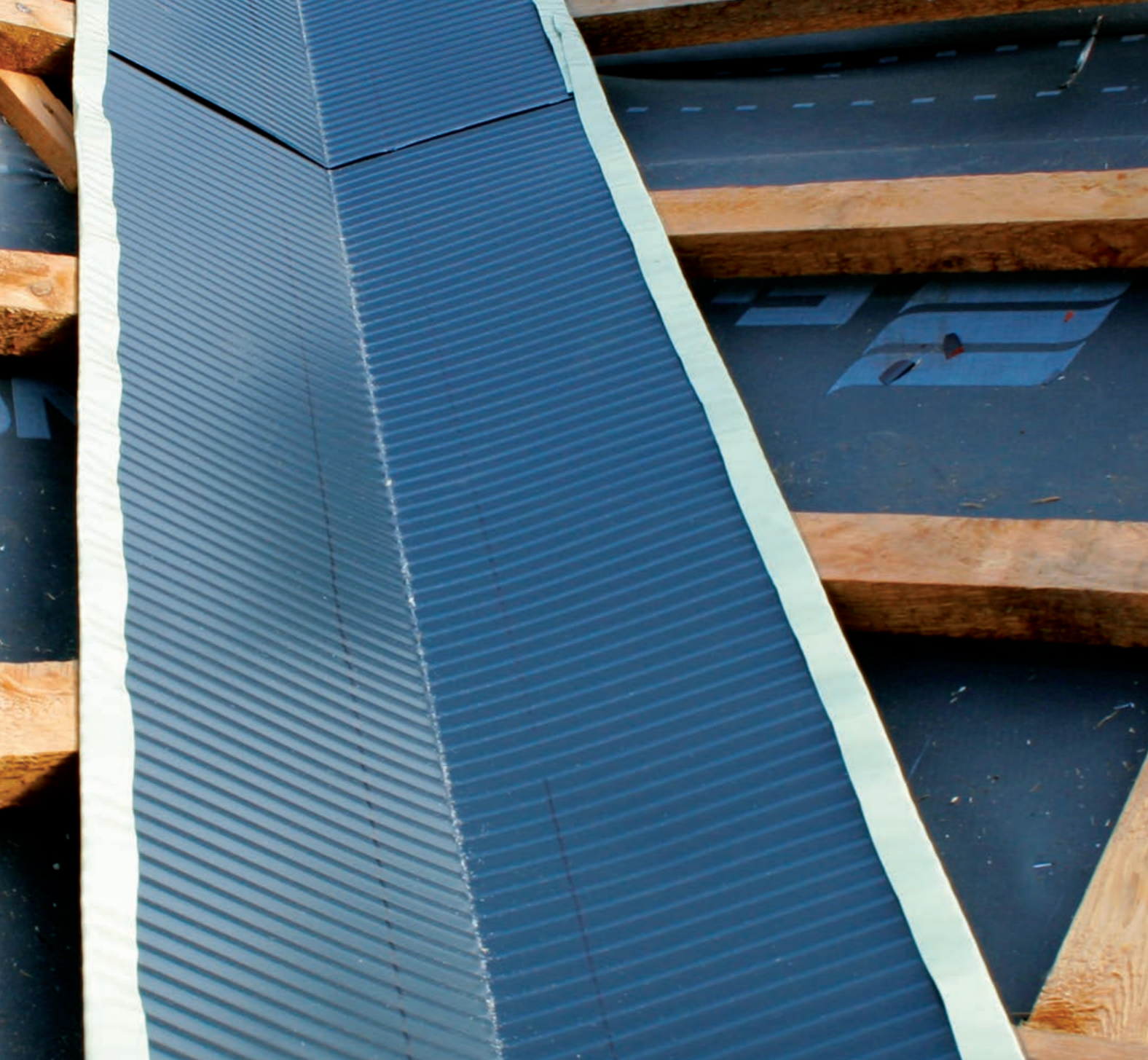

## › Valley

The system of finishing elements of a valley area ensures durable sealing of neighbouring roof slopes as well as proper water drainage to the guttering.



### VALLEY Q

- Roof valley, crosswise profiled, made of aluminum sheet, coated with polyester paint.
- Designed for use as a flashing element between two neighbouring roof slopes. Ensures proper drainage of water from the roof.

 500 mm x 2 m  RAL: 8004; 8017; 8019; 9005; 7021; 8015; 3011

 10 pcs.  400 pcs.

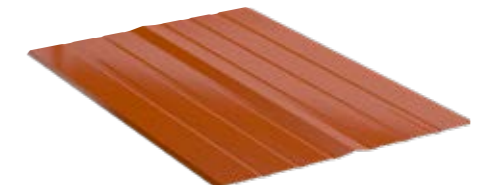

### VALLEY L

- Roof valley, longitudinally profiled, made of aluminum sheet, coated with polyester paint.
- Designed for use as a flashing element between two neighbouring roof slopes. Ensures proper drainage of water from the roof.

 500 mm x 2 m  RAL: 8004; 8017; 8019; 9005; 7021; 8015; 3011

 10 pcs.  400 pcs.



### VALLEY CLIP

- Roof valley clip made of aluminum sheet and coated with polyester paint.
- Used as a mounting element of the roof valley to the roof structure. Ensures precise installation of the valley without a need to drill additional openings.

 RAL: 8004; 8017; 8019; 9005

 50 pcs.  10 000 pcs.



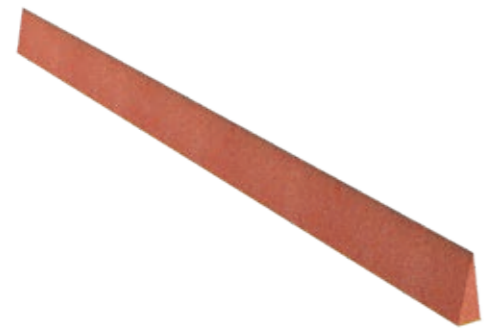

## WEDGE

- Valley wedge made of polyurethane foam with a self-adhesive layer.
- Used for sealing in the place where the roof valley is connected to the roof slope.
- Perfectly adjusts to the shape of the covering.

60 mm x 1 m  
wall red; brown; anthracite

200 pcs. 2000 pcs.



## SEAL 4

- Rectangular valley wedge made of polyurethane foam with a self-adhesive layer.
- Used for sealing in the place where the roof valley is connected to the roof slope.
- Perfectly adjusts to the shape of the covering.

40 mm x 30 mm x 1 m  
wall red; brown; anthracite

100 pcs. 1600 pcs.

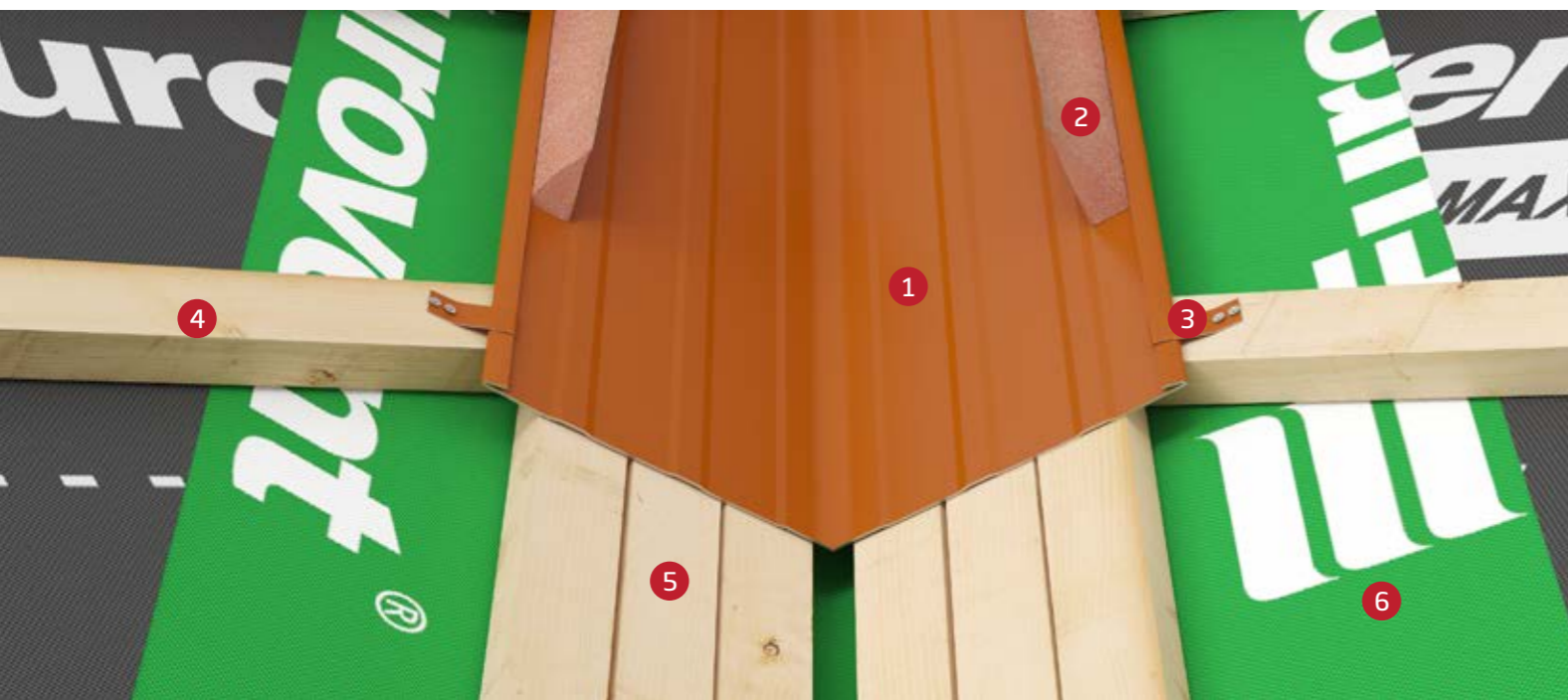

### › Application of a Eurovent® VALLEY L

- |                      |                         |                   |
|----------------------|-------------------------|-------------------|
| 1 Eurovent® VALLEY L | 3 Eurovent® VALLEY CLIP | 5 Valley boards   |
| 2 Eurovent® WEDGE    | 4 Battens               | 6 Eurovent® SUPER |

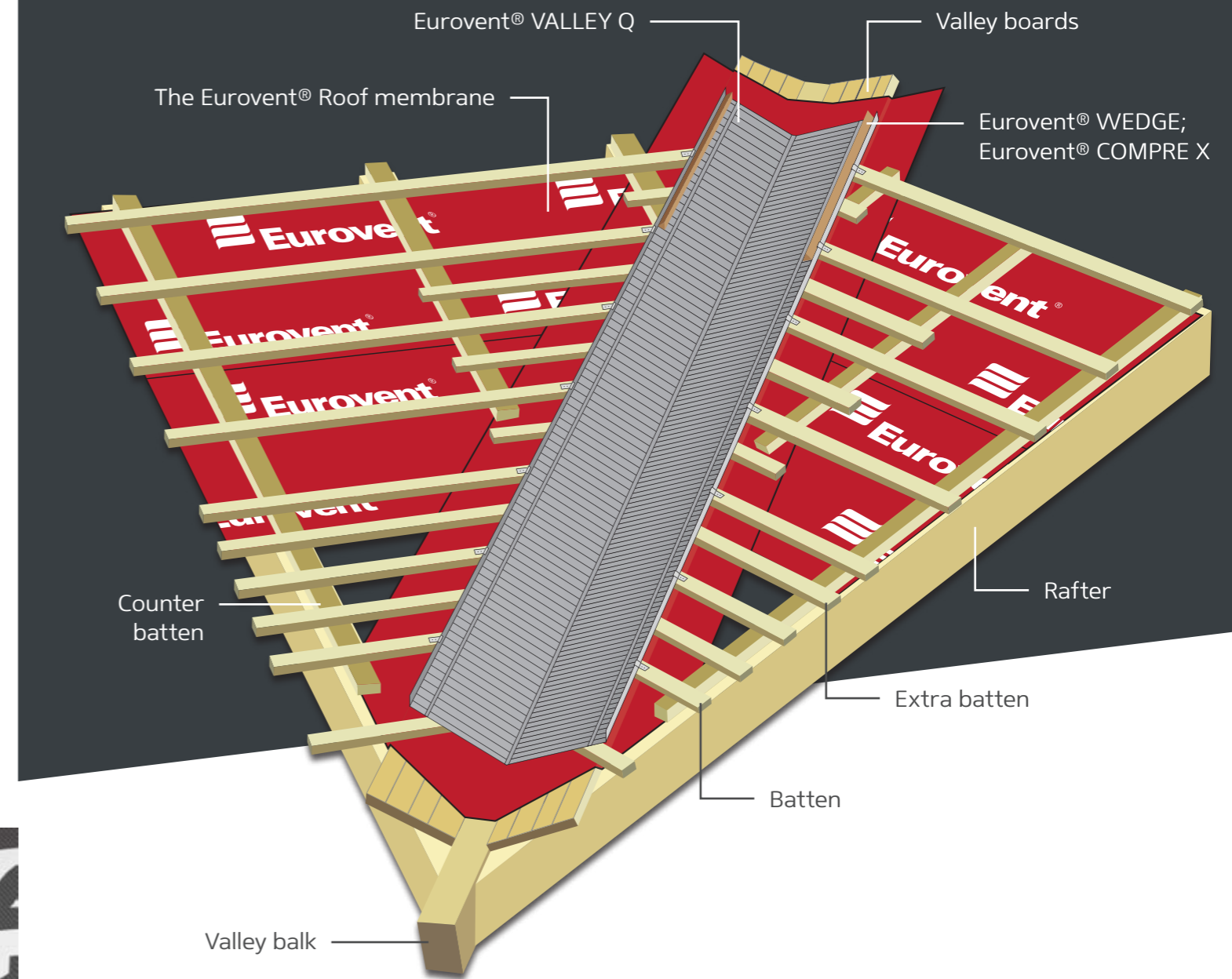

## ROOF VALLEY

Appropriately performed roof valley finishing work drains water to the guttering system as well as seals the joining of two neighbouring roof slopes.

Installation of a roof valley in a few steps

- Use the valley boarding along the valley balk
- Pad the boarded valley out with a roof membrane.
- Use thickened battening in the valley area.
- Put the previously profiled valley steel metal and attach it with the use of valley clips.
- Remember to use the valley steel metal overlaps of 10 cm minimum
- Seal the installed valley with the use of wedges or the COMPRE X tape.



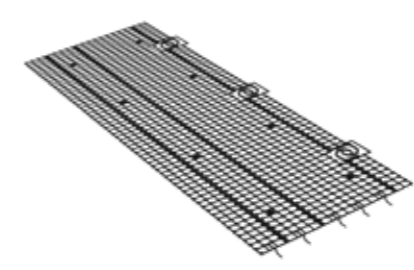

## GUTTER PROTECT

- Gutter protect made of plastic.
- Used to protect both plastic and metal gutters against leaves and other contaminations.
- Side hooks enable fast and easy installation.



175 mm  
x 600 mm



RAL: 9005



5 pcs.



3200 pcs.

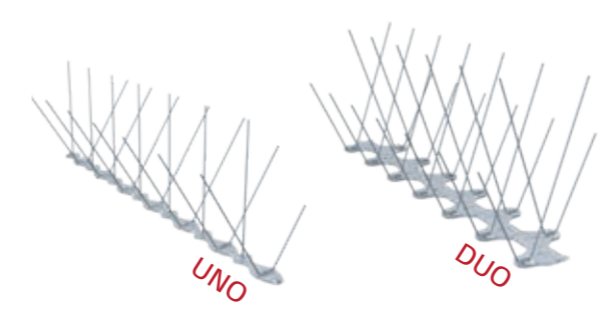

## ANTIBIRD

- Protective element made of a polycarbonate support and flexible steel spikes.
- Designed to protect roofs, facades, cornices, window sills and other areas of the building exposed to birds' sitting and nesting.



60 mm x 335 mm x  
110 mm



RAL: 9006



150 pcs.



2100 pcs.

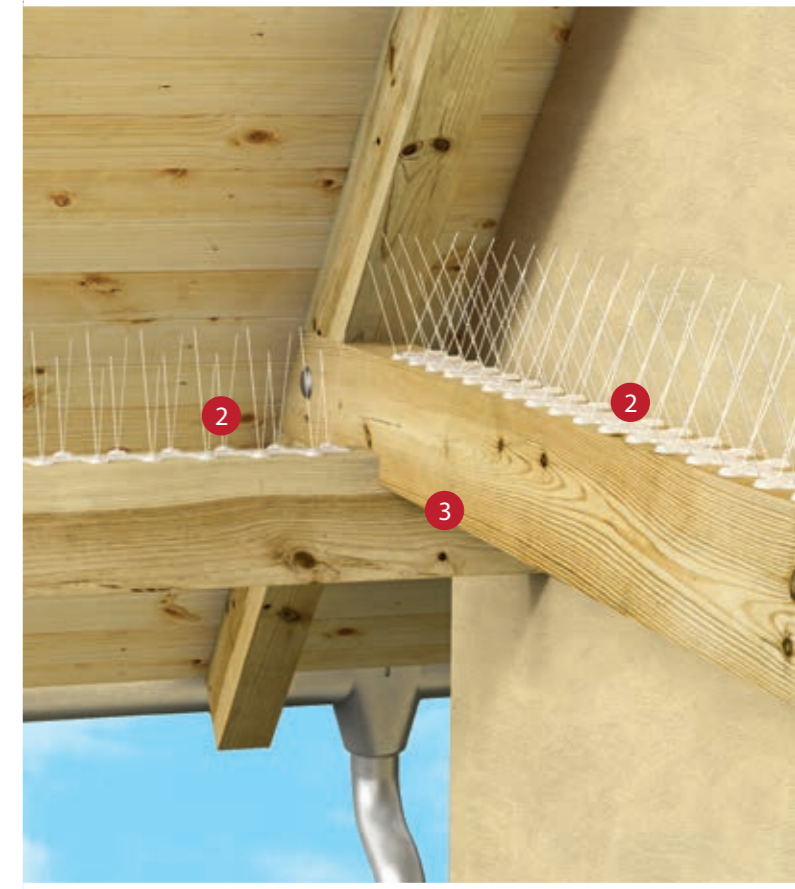

# › Protection and ventilation

A set of elements for various types of protection in the roof area and the ventilation system of a roof and an attic.

### › Protection

- 1 Eurovent® GUTTER PROTECT
- 2 Eurovent® ANTIBIRD DUO
- 3 Construction
- 4 Roof cover





# VENTOS X

ROOFING VENT

Eurovent® VENTOS X is an advanced roofing vent with the venting diameter of 170 mm and the venting entry of 150 mm.

Dedicated design effectively supports ventilation using the energy of the wind, ensures correct run of the air through improved capacity of the vent.

It is equipped with the anti condensation system which prevents condensation affecting thermal insulation.

Used as a roof outlet for mechanical and gravity ventilation ducts.

Ø 150 mm

RAL: 8004; 8019; 9005; 8017; 7024; 3009; 7021; 7036; 6020

1 set

36 sets

## › Eurovent® VENTOS X – metal sheet roofing cover

- 1 Eurovent® VENTOS X METAL
- 2 Eurovent® CLASSIC
- 3 Eurovent® PUR
- 4 Thermal insulation
- 5 Metal roofing sheets



## CONSTRUCTION

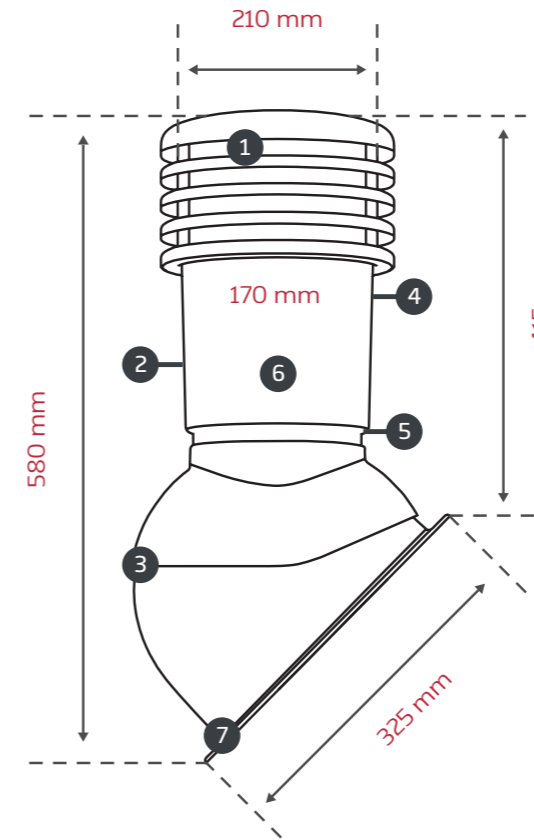

- 1 TOP CAP - a special ring shape with the internal diameter of 210 mm supports gravity ventilation by using the wind energy to increase the run of the air through the venting channel.
- 2 SURFACE - it is made the way it decreases the ability to absorb dust and dirt.
- 3 ADJUSTMENT - the vent enables to control the slope angle related to the roofing cover.
- 4 COLORS - wide range of colours according to popular colours used for the roofing covers.
- 5 ANTICONDENSATION SYSTEM - it has advanced system draining the condense water from the inside to of the venting channel directly onto the roofing cover.
- 6 FLOW - increased air flow through a wide ventilation channel of the diameter of 170 mm.
- 7 BASE PLATE - water tight base plates matching the shapes of different types of the roofing covers.

## CERTIFICATE

The vent Eurovent® VENTOS X has been approved by a Building Techniques Institute.

ITB-KOT-2019/1007

The comparison chart shows the air flow of the vents with the diameter of 125 and 150 mm.\*

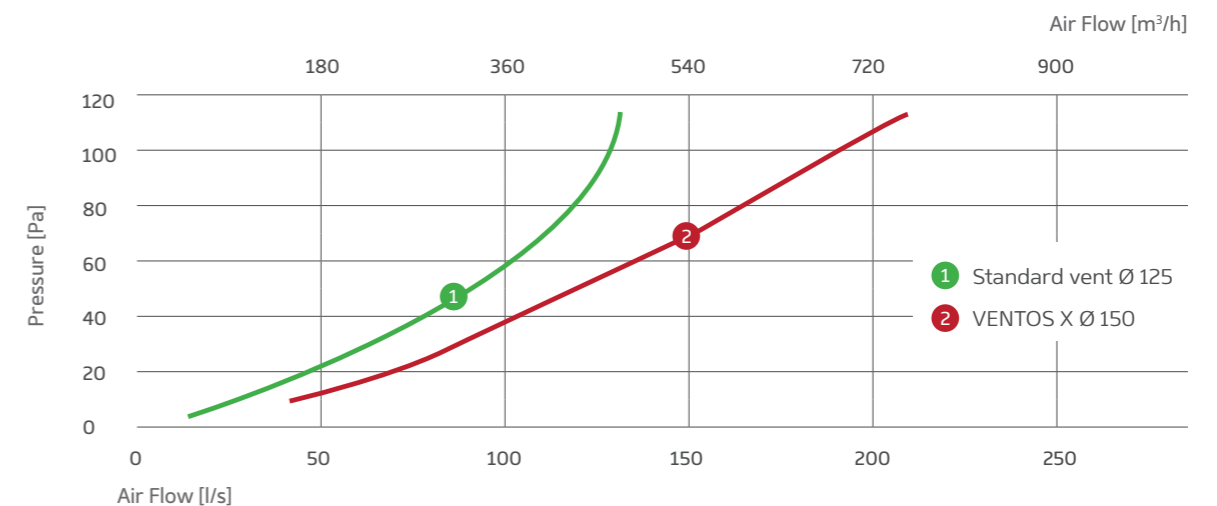



# BASE PLATES

Water tight base plates for Eurovent VENTOS X enable easy and quick installation on different kinds of metal roofing sheets, concrete roof tiles and bitumen shingles.



METAL N25



METAL G18



METAL M11



METAL R28



BITU O



METAL F22



METAL W35

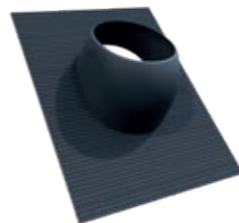

BITU UNI



METAL B26



METAL T35\*



METAL T18\*

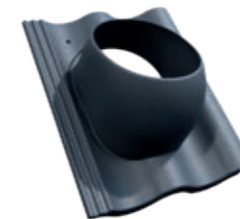

C

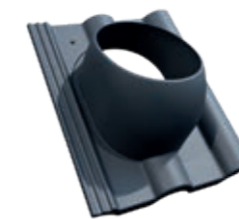

R



S\*

## METAL T18; METAL T35

Trapezoidal sheet metal, model 18 and 35 mm

### C

BRAAS CELTYCKA  
BENDERS PALEMA  
NELSKAMP SIGMA

### R

BRAMAC ALPEN DACHSTEIN  
NELSKAMP FINKENBERGER  
BENDERS MECKLENBURGER  
PRODACH PODWÓJNA  
RZYMSKA  
BRAAAS ROMAŃSKA

### S

BRAAS BAŁTYCKA S  
BRAMAC DONAU DACHSTEIN  
NELSKAMP ESÓWKA S  
PRODACH PODWÓJNA  
ESÓWKA  
IBF PODWÓJNA S

\*The list of Producers is at pages 124-131

\*The list of Producers is at pages 124-131

## › Eurovent® VENTOS X – Trapezoidal sheet metal

- 1 Eurovent® VENTOS X BITU UNI
- 2 Eurovent® XSTRONG
- 3 Eurovent® PUR
- 4 Thermal insulation
- 5 Trapezoidal sheet metal

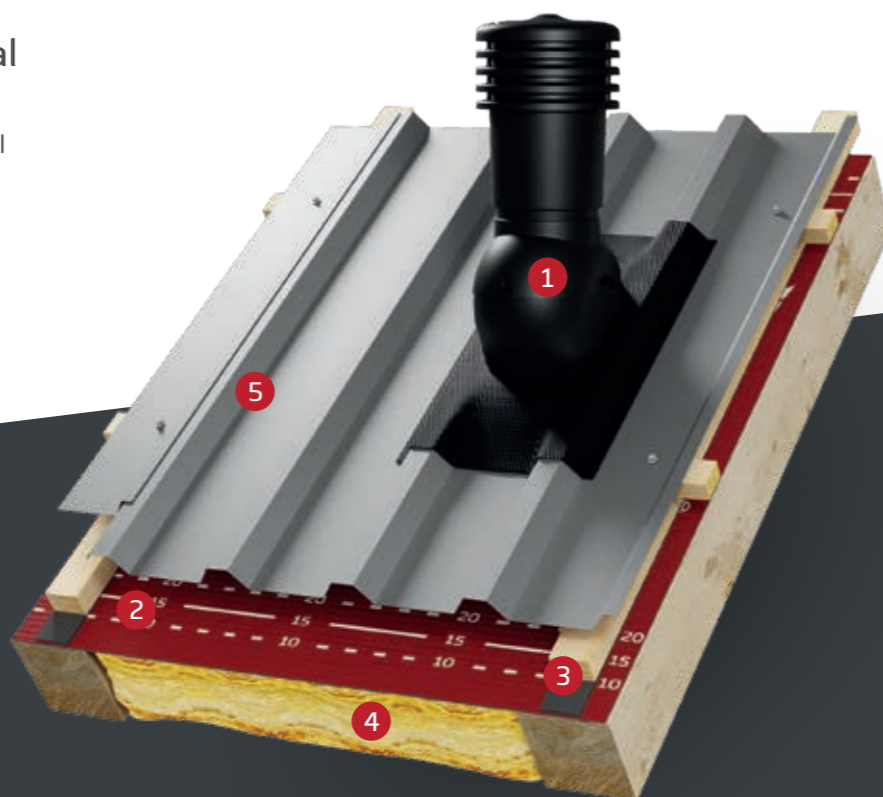

## SATTOS X\*

- An antenna adapter manufactured from plastic and tipped with a rubber cap.
- Used for mounting antennas with a mast diameter from 15 to 65 mm.
- For sloping roofs covered with all types of roof coverings.



1 set



96 sets



## VENTOS X FLAT\*

- Air vent slope chimney manufactured from plastic.
- Used for sloping roofs, covered with metal, concrete, ceramic tiles or bituminous shingle.



1 set



96 sets



# VENTILATION IN BUILDING

## Basic types of ventilation

### GRAVITY VENTILATION

- The easiest and the most affordable system of the air exchange in the buildings
- Waisted air is suck out from the inside under the influence of the air pressure difference between the inside and the exit of the venting channel.
- Fresh air is supplied by the micro gaps in the windows and doors or by the dedicated air outlet grill.
- No control ability, ventilation intensity depends on the atmospheric conditions.

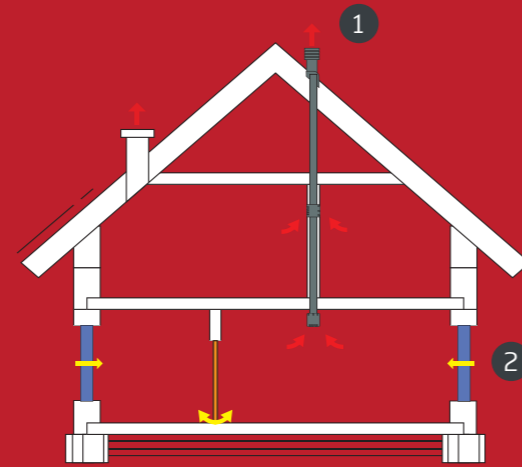

1 Extract flow 2 Gaps

### HYBRID VENTILATION

- The combination of the mechanical and gravity ventilation .
- Mechanical ventilation is supposed to support gravity ventilation depending on the demand or on the atmospheric conditions when the air exchange based on the gravity ventilation is not sufficient.
- Possible partial control.

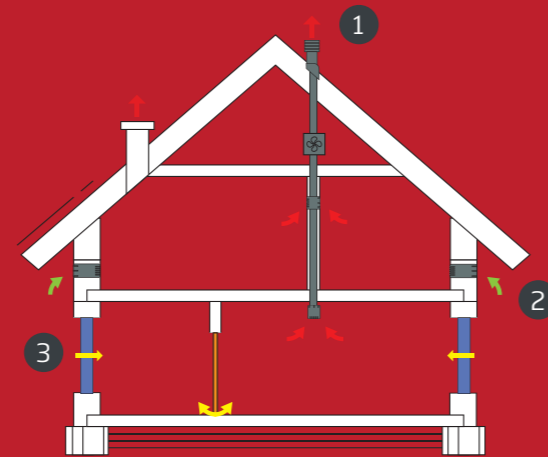

1 Extract flow 2 Supply flow 3 Gaps

### MECHANICAL VENTILATION - RECUPERATION

- This is an advanced mechanical ventilation system with recuperation which enables retrieving the heat back from the extract air.
- It is effective, ecological solution assuring the highest comfort and fresh and clean air in the building.
- System controls quality and conditions of the air inside the building.
- It is well approved in the air tight passive houses.

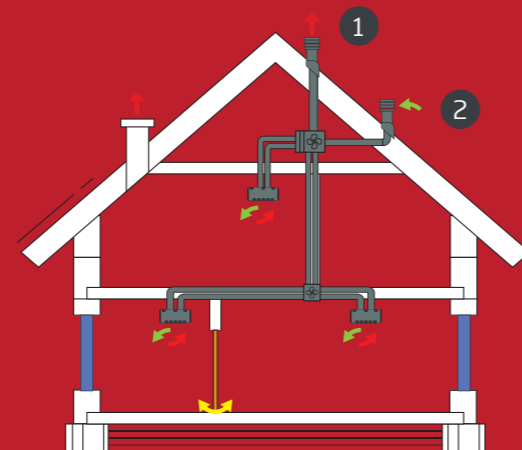

1 Extract flow 2 Supply flow - inlet

## Sufficient ventilation

Sufficient ventilation in the buildings provides healthy microclimate and good quality of the air in the rooms.

Correctly working ventilation removes out from the interior: CO<sub>2</sub>, water vapour, CO, smells, smoke, etc. Prevents mildew growth and other damages caused by the damp.

Properly functioning ventilation does not cause uncontrolled air runs and reduces the need for heat energy thanks to the controlling ability of the venting efficiency, which makes it possible to increase or decrease the exchange of air as required.

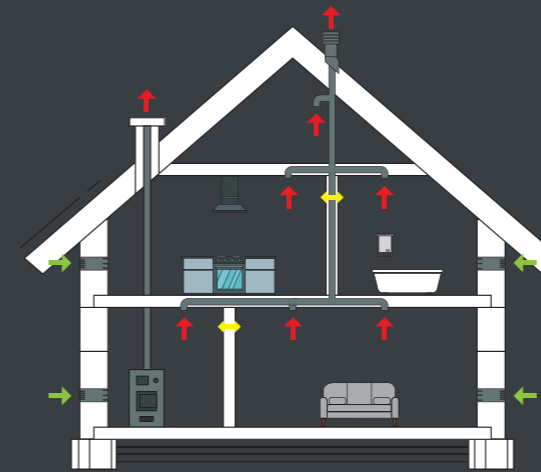

- Fresh, oxidized air free of bad smells and pollution.
- Adjustable ventilation force, energy saving, noise reduction.
- No draughts and heat loss, proper air circulation.
- Good feeling, ease of concentration, healthy air in the building.

## Unsuufficient ventilation

Unsuufficient ventilation causes cumulation of the unhealthy substances in the air and leads to the unhealthy building syndrom.

There are many dangerous substances that may exist in the air that may influence people's health and their feeling. The most dangerous are water vapour and car+bo oxygens. Their high density in the air make headache, feeling of being tired, respiratory system diseases.

Unsuufficient ventilation impacts on the construction of the buldings, causes damp on the substrates, on the thermal insulation and the mildew growth.

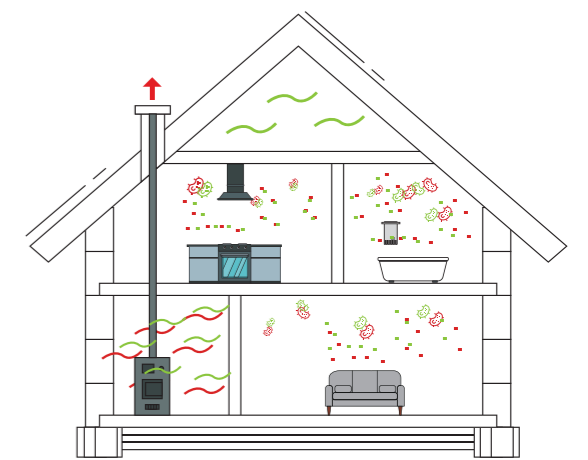

- Too big quantity of the water vapour, carbo oxygenes and other gases.
- Mildew growth, allergens cumulation, viruses.
- Higher relative humidity of the air - water vapour condensation.
- Bad feelings, diseases.





## FLEXOS X

- Flexible duct made of special plastic finished with reduction of a wide range of diameters.
- Used as an element connecting ventilation chimney for the roof with an attic.
- It has a wide range of lengths and angle adjustment, recommended for demanding connections.

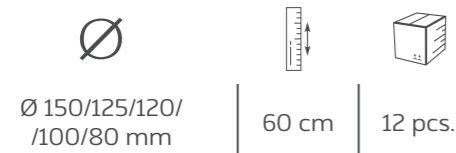

## CLIP X

- Connector made of plastic.
- Enables fast and tight connection of ventilation canals Eurovent® FLEX X and Eurovent® FLEXOS X



## FLEX X

- Flexible duct made of special plastic.
- Used as a canal which connects ventilation system in a building with a ventilation chimney.
- It has a wide range of lengths and angle adjustment, recommended for demanding connections.

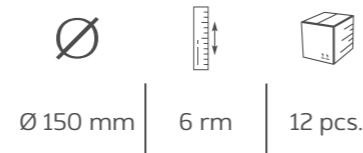

## RING X

- Reduction made of plastic.
- Enables direct connection of the Eurovent® FLEX X canal or the Eurovent® VENTOS X ventilation chimney with pipes of 110 mm or 125 mm diameters.

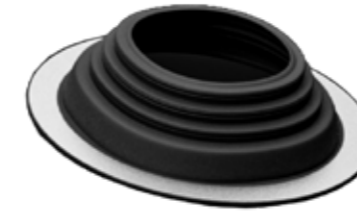

## SEAL EPDM

- Range of seals used for insulating venting channels going through the roof.
- Wide range of available diameters enable application with many types of the pipes and channels.

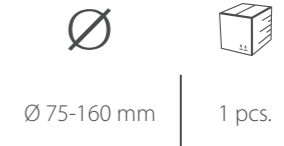

### › Application of ducts Eurovent® FLEXOS X and FLEX X

- 1 Eurovent® FLEXOS X
- 2 Eurovent® FLEX X
- 3 Eurovent® RING X
- 4 Eurovent® UNO
- 5 Eurovent® UNISAN
- 6 Eurovent® CLIMA
- 7 Thermal insulation



## METAL ROOFS - PRODUCERS LIST

Metal roof tiles types	Producer	Plate
<b>A</b> ADA	BLACHY MINDA	N25
ADAMANTE	RUKKI	R28
AGA	BLACHCENTRUM	N25
AGA	LIMBLACH	W35
AGAT	POLSTAL	W35
AKCENT	FINCO-STAL	N25
AKORD	FINCO-STAL	N25
ALFA PREMIUM, ALFA PLUS	BLACHPROFIL 2	N25
ALLANO*	BRATEX	N25
AMALFI PLUS	BLACHDOM PLUS	F22
AQUA	BLOK-BUD/BLOKBLACH/FINNOYA	W35
ARAD OPTIMA/ARAD PREMIUM	PRUSZYŃSKI	R28
ARIA	BUDMAT	W35
ARMANO	DACHY ŁUCZAJ	F22
ASTRA	POLONICA	F22
ATENA	NOWAX	N25
<b>B</b> BANGA	ROZBUD	N25
BARCELONA	DACHY ŁUCZAJ	W35
BELLA	STALHART	W35
BELLA SARA	BUDMAT	N25
BESKID	BLACHDOM PLUS	B26
BESKID PLUS	BLACHDOM PLUS	B26
BETA	BLACHPROFIL 2	N25
BETA	POLSTAL	W35
BIEBRZA	AATESTPOL	N25
BINGO	BLACHODACH	N25
BOLERO	BLACHODACH	B26
BONA/BONA PLUS/BONA LONG	BLACHDOM PLUS	N25
BONITA/BONITA PLUS	DOM-BLACH	N25
BRAVO	BLACHODACH	N25
BRYLANT	BLACHY PIOTRKOWICZ	N25
BURSZTYN	WŁASTAL	N25
<b>C</b> CAMESA	M-BLACH	N25
CARO+/CARO	POLSTAL	N25
CENTRO	BRATEX	B26
CESAR	FINISH PROFILES	W35
CLASSIC	WŁASTAL	N25
<b>D</b> DAKOTA	BLACHSTAL	N25
DANA	GÓRHUT	N25
DECORREY	RUKKI	N25
DIAMENT ECO	BLACHOTRAPEZ	N25
DIAMENT PLUS	BLACHOTRAPEZ	W35
DIANA	NOWAX	W35
DOMINUM PANEL	BLACHY MIDA	M11

\* Additional butyl stripes must be ordered

## METAL ROOFS - PRODUCERS LIST

Metal roof tiles types	Producer	Plate
<b>D</b> DONA/DONA ECO	GLINMET/WISTAL	N25
DUNA	ZEPART	W35
DUO	REGAMET	M11
<b>E</b> ECO	BLACHPROFIL 2	N25
ECO NICOL	MAX SYSTEM	N25
ECO OLIVIA	MAX SYSTEM	W35
ECOMAX	BUDMAX-METAL	N25
EGERIA	DACHPOL	G18
ELEGANT	BORGA	N25
ELIOS	POLONICA	W35
ELITA	BLACHSTAL	W35
EMI	UNBLACH	N25
ENIGMA*	BLACHOTRAPEZ	W35
ESKA	BLACH-POL	N25
ESTIMA	BLACHOTRAPEZ	BITU O
EURO	BLACHPROFIL 2	N25
EUROPA	FLORIAN CENTRUM	W35
EVELINE	BLACHY WADOWSKI	N25
<b>F</b> FALA	WAT	W35
FERRERA	BUDMAT	W35
FINEZJA	FLORIAN CENTRUM	G18
FINISH/FINISH MAX	FINISH PROFILES	N25
FINISHDAK	FINISH PROFILES	N25
FINLANDIA/FINLANDIA DE LUX	BLACH-POL	F22
FINNERA	RUKKI	F22
FIŃSKA	METALEX MIKOŁAJOWICE	W35
FLAMENCO	BLACHODACH	F22
FLEX	PLANNJA	F22
FLORINA	FLORIAN CENTRUM	N25
FORTE PANEL/ CLASSIC	FINCO STAL	R28
FRANIA SYMETRIC	MATPOL	G18
FRIGGE	RUKKI	M11
FUTURA	DACHPOL	M11
<b>G</b> GALLA	GLINMET/WISTAL	W35
GALLA	WAT	R28
GAMMA 25/GAMMA 35MM	BLACHPROFIL 2	F22
GERMAN	BLACHSTAL	F22
GERMANIA/GERMANIA SIMETRIC*	BLACHOTRAPEZ	G18
GLORIA	REGAMET	N25
GOLD	TRAFFIC	N25
GRYF	PRUSZYŃSKI	F22
<b>H</b> HALNY	ARCELOR MITTAL (ARMAT)	N25
HEKTOR	WŁASTAL	N25

\* Additional butyl stripes must be ordered



## METAL ROOFS - PRODUCERS LIST

Metal roof tiles types	Producer	Plate
<b>H</b> HELIOS	TRANSTAL	N25
HELIOS PLUS	TRANSTAL	N25
HERA	BRATEX	N25
HERKULES	BLACHSTAL	F22
HESTIA	BRATEX	N25
HONORATA	SOLAN	W35
HORYZONT	BALEXMETAL	N25
HUSARIA	BLACH-POL	G18
<b>I</b> IDA	FLORIAN CENTRUM	N25
IMPERIA PLUS	BLACHDOM PLUS	N25
IRIS	DACHPOL	N25
<b>J</b> JANOSIK	BLACHOTRAPEZ	BITU O
JOHN STEEL	FINISH PROFILES	R28
JOKER	BLACH-DOM	N25
JOWISZ	DACH-STYL	W35
JULIA	MATPOL	N25
<b>K</b> KAJA+/KAJA	ROLBUD	N25
KARA	UNIBLACH	W35
KARAMZYN	TRANSTAL	F22
KARPATIA	DACH-STYL	F22
KIARA	TRANSBLACH	W35
KING/KING MAX/KINGSTILE	FINISH PROFILES	N25
KING/KING PLUS	BLACHSTAL	N25
KINGA	STALHART	N25
KINGA/KINGA PLUS	FLORIAN CENTRUM	N25
KINGAS/KINGAS ECO/KINGAS PLUS	BLACHOTRAPEZ	N25
KLARA	FLORIAN CENTRUM	W35
KLAUDIA	LIMBLACH	N25
KOBRA	FLORIAN CENTRUM	N25
KORONA PLUS	BLACHDOM PLUS	N25
KORRA	TRANSBLACH	N25
KRISLINE	BLACHY WADOWSKI	W35
KRON	PRUSZYŃSKI	W35
KURPIANKA	KURPDACH	N25
KWADRA	FINCO STAL	BITU O
<b>L</b> LARGO PANEL/ LARGO CLASSIC	FINCO STAL	F22
LENA/ LENA MAX	WAT	G18
LENA	ZEPART	W35
LIBRA	METALMIX	N25
LIDIA	FLORIAN CENTRUM	F22
LPAL	LINDAB	N25
LUNA	DISPOL	N25
LUNA	POLONICA	N25

\* Additional butyl stripes must be ordered

## METAL ROOFS - PRODUCERS LIST

Metal roof tiles types	Producer	Plate
<b>M</b> M35	SOLAN	N25
MAGNAT	BUDMAX-METAL	N25
MAJA	FLORIAN CENTRUM	R28
MAJOR	WAT	N25
MALTA	HANBUD	F22
MARII	LIMBLACH	G18
MARY STEEL/ MARY STEEL L	FINISH PROFILES	F22
MAXIMA	REGAMET	F22
MAZOWSZANKA	KURPDACH	W35
MEGA	LINDAB	W35
MERKURY	DACH-STYL	N25
METIS	DACHPOL	N25
METRUM	FINCO-STAL	F22
MILO/ MILO PLUS	TRANSTAL	W35
MODENA	STAHLBERG	N25
MODERNO	HANBUD	F22
MODUŁOWA	ROZBUD	F22
MODUS	PRUSZYŃSKI	R28
MONA	REGAMET	F22
MONTERREY TS 39/ TS 34 FEB FORMA	RUKKI	N25
MONZA	GLINMET/WISTAL	W35
MURANO	BUDMAT	M11
MUSTANG	BLACH-POL	B26
<b>N</b> NANO	FINCO STAL	BITU O
NAREW	ATESTPOL	W35
NATURA	BLOK-BUD/ BLOKBLACH/ FINNOYA	N25
NICOL	MAX SYSTEM	N25
NORA	BIAL-MET	N25
NORD*	HANBUD	W35
NORDA	INTER-MAX	N25
NORDICA+/ NORDICA PANEL	BLACHY MINDA	F22
NOVA	ROZBUD	W35
NOVATIK PREMIUM	NOVATIK	BITU O
<b>O</b> OLGA	BLACHY PIOTRKOWICZ	N25
OLIMPIA	REGAMET	W35
OLIVIA	MAX SYSTEM	W35
OMEGA	BLACHPROFIL 2	W35
ONYX	BLACHY ZIEMIŃSKI	F22
OPTIMA ARAD	PRUSZYŃSKI	R28
OPUS*	BLACHODACH	BITU O
<b>P</b> PANORAMA	BALEXMETAL	F22
PETRA DUO	REGAMET	G18
PAULA	DOM-BLACH	W35
PERFECTA	STAHLBERG	N25

\* Additional butyl stripes must be ordered



## METAL ROOFS - PRODUCERS LIST

Metal roof tiles types	Producer	Plate
<b>P</b> PERŁA	WŁASTAL	N25
PERŁA/PERŁA PLUS	BLACHDOM PLUS	W35
PIANO CLASSIC/ PIANO PREMIUM	FINCO-STAL	R28
PIANO PANEL ESTETICA/ STANDARD	FINCO-STAL	R28
PLATINO*/ PLATINO ECO*	BRATEX	N25
PLATINIUM/PLATINIUM ECO	TRAFFIC	F22
PODLASIE	BIALMET	W35
PLATINIUM	ŁUCZAJ	N25
POLA	POLSTAL	F22
POLARIS	METALMAX	BITU O
POLONIA	KURPDACH	G18
PRESTIGE	STAHLBERG	F22
PRIMA	BLACH-POL	W35
PROXIMA*	METALMIX	N25
<b>Q</b> QUATTRO/ QUATTRO SYMMETRICA	BLACHSTAL	G18
<b>R</b> REGENT/ REGENT GRAND	PLANNJA	N25
REGLE	PRUSZYŃSKI	BITU O
REN	PRUSZYŃSKI	R28
REVERS	METALEX MIKOŁAJOWICE	B26
RIKI	VICOR	N25
ROMA	REGAMET	R28
ROZALIA	FLORIAN CENTRUM	G18
RUBIN PLUS	PRUSZYŃSKI	N25
RZYMSKA	DACH-METAL	W35
<b>S</b> SARA	BUDMAT	N25
SATURN	DACH-STYL	N25
SAVANNA	BRATEX	BITU O
SCANDIA	METALEX MIKOŁAJOWICE	W35
SCANDIC LINE/ SCANDIC MODULAR	PLANNJA	N25
SCANDINAVIA	BRATEX	F22
SEGMENT	TRANSBLACH	N25
SIMELINE	BLACHY WADOWSKI	G18
SILVER	TRAFFIC	N25
SIÓDEMKA	DACHPOL WŁOSZCZOWA	F22
SMART	PLANNJA	N25
SOLIS	BLOK-BUD/BLOKBLACH/FINNOYA	F22
SONATA	BLACHODACH	W35
SPECJAL	BLACHY PIOTRKOWICZ	N25
SPEKTRUM	BALEXMETAL	N25
STANDARD	ŁUCZAJ	N25
STELLA	DISPOL	N25
SYMETRIA	BLACH-POL	F22
SYMETRIA	NOWAX	G18
SYMETRIA DE LUX	BLACH-POL	F22

## METAL ROOFS - PRODUCERS LIST

Metal roof tiles types	Producer	Plate
<b>S</b> SZAFIR	PRUSZYŃSKI	N25
SZKOCKA	BLACH-POL	M11
<b>T</b> TAKT	FINCO-STAL	N25
TALIA*	BLACHOTRAPEZ	N25
TANGO	FINCO-STAL	W35
TEMIDA	GLINMET/WISTAL	G18
TOPAZ	WŁASTAL	W35
TOPLINEL (LPAN)	LINDAB	N25
TYSENIA	BLACHOTRAPEZ	BITU O
TUR	PRUSZYŃSKI	F22
TWIST	BLACHODACH	N25
<b>V</b> VENESSA/VANESSA SIMETRIC	DOM-BLACH	G18
VEGA	FINCO-STAL	N25
VEGA	METALMIX	W35
VELLO	BRATEX	N25
VELA	INTER-MAX	G18
VENA*	HANBUD	N25
VENECJA	BUDMAT	F22
VERA	UNIBLACH	N25
VIKA	VICOR	N25
VIKTORIA	REGAMET	N25
VIVALDI	ARECO SWEDEN	N25
<b>W</b> WESTA	INTER-MAX	W35
WIKTORIA	METALEX MIKOŁAJOWICE	N25
<b>X</b> XARA	ZEPART	N25
<b>Z</b> ZEFIR	BUDMAT	N25
ZET	BLACHPROFIL 2	F22
ZUZIA	MATPOL	W35

\* Additional butyl stripes must be ordered





## CONCRETE ROOF TILES

### - PRODUCERS LIST

Concrete roof tiles types	Producer	Plate
<b>A</b> ALPEN DACHSTEIN	BRAMAC	R
<b>B</b> BAŁTYCKA S	BRAAS	S
<b>C</b> CELTYCKA	BRAAS	C
<b>D</b> DONAU DACHSTEIN	BRAMAC	S
<b>E</b> ESÓWKA S	NELSKAMP	S
<b>F</b> FINKENBERGER	NELSKAMP	R
<b>M</b> MECKLENBURGER	BENDERS	R
<b>P</b> PALEMA PODWÓJNA RZYMSKA PODWÓJNA ESÓWKA PODÓWJNA S	BENDERS PRODACH PRODACH IBF	C R S S
<b>R</b> ROMAŃSKA	BRAAS	R
<b>S</b> SIGMA	NELSKAMP	C

## BITUMEN SHINGLES

### - MODELS OF PLATE

#### BITU O

Bitumen shingles  
 Tar paper  
 Insulated metal panels;  
 Standing seam;  
 Profiled metal sheets;  
 FLAT ROOFING COVERINGS - OTHERS;  
 -INSTALLED ON THE ROOF COVERING

#### BITU UNI

TRAPEZOIDAL SHEET METAL  
 -INSTALLED ON THE ROOF COVERING







## › Snow protection

The snow protection system eliminates the phenomenon of excessive snow quantities sliding down from a roof slope. Mounting elements make the installation easier in case of any roof covering.

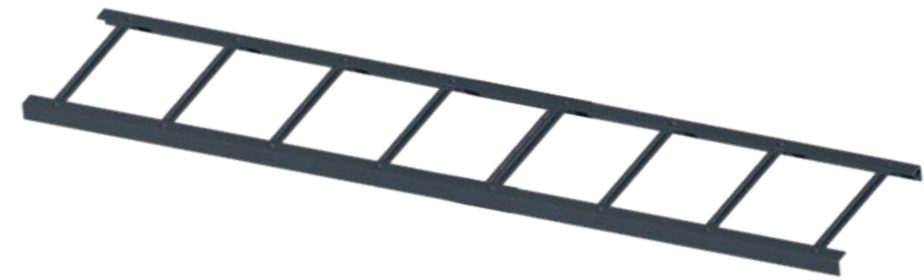

### SNOWSTOPPER

- Snowstopping grate manufactured from galvanized steel, connections made in the TOX technology.
- Designed for use as a anti-snow protection element on sloping roofs. It also prevents against movements of mass quantities of snow.



1,0 m; 2,0 m; 3,0 m



Galvanized\*; RAL: 8004; 8017; 8019; 9005; 6020; 7016; 3009; 3004; 7024



2 pcs.



### FIX UNI

- Adapter for a snowstopping grate. Made from galvanized steel, connection made in the TOX technology.
- Universal adapter which mounts a snowstopping grate to flat roof coverings of an angle ranging from 15 to 60 degrees.



Galvanized\*; RAL: 8004; 8017; 8019; 9005; 6020; 7016; 3009; 3004; 7024



5 pcs.



### FIX DB-DC

- Adapter for a snowstopping grate. Made from galvanized steel, connection made in the TOX technology.
- Adapter which mounts a snowstopping grate to roofs of an angle ranging from 15 to 60 degrees and covered with concrete or ceramic roof tiles.



Galvanized\*; RAL: 8004; 8017; 8019; 9005; 6020; 7016; 3009; 3004; 7024



5 pcs.



# SNOWSTOPPER

TOX – SYSTEM OF JOINING ELEMENTS

TOX is a modern cold joining elements technology. It is well known for, among others, the car industry. Due to the method, we are able to achieve joinings of the highest durability as well as aesthetics of production in comparison to traditional welding.



The TOX joinings has been introduced (is available) for:

- The Eurovent® SNOWSTOPPER snow-stopping grate
- The EUROVENT® FIX brackets of a snow-stopping grate
- The Eurovent® SNOWSTOPPER SET system of snow-stopping protection



## FIX BIBER

- Adapter for a snowstopping grate. Made from galvanized steel, connection made in the TOX technology.
- Used as a mounting element of a snowstopping grate on sloping roofs covered with ceramic beaver-tail roof tiles laid in double-lap pattern.



Galvanized; RAL: 8004; 8017; 8019; 9005; 6020; 7016; 3009; 3004; 7024

5 pcs.



## FIX METAL PANEL

- Adapter for a snowstopping grate. Made from galvanized steel, connection made in the TOX technology.
- Used as a mounting element of a snowstopping grate on sloping roofs covered with metal panel tiles of module 370/35 mm. Blachotrapez JANOSIK; Metro SHAKE II, Pruszyński REGLE, Novatik PREMIUM; HARNAŚ.



Galvanized; RAL: 8004; 8017; 8019; 9005; 6020; 7016; 3009; 3004; 7024

5 pcs.



### › Application of a Eurovent® SNOWSTOPPER SET METAL 400

- |                           |                   |                  |
|---------------------------|-------------------|------------------|
| 1 Eurovent® SNOWSTOPPER   | 3 Eurovent® SUPER | 5 Counter batten |
| 2 Eurovent® FIX METAL 400 | 4 Batten          | 6 Roof cover     |





## FIX METAL 350

- Adapter for a snowstopping grate. Manufactured from galvanized steel, connection made in the TOX technology.
- Used as a mounting element of a snowstopping grate on sloping roofs covered with profiled metal roof tile of module 350/20 mm.



Galvanized; RAL: 8004; 8017; 8019; 9005; 6020; 7016; 3009; 3004; 7024

5 pcs.



## FIX METAL 400

- Adapter for a snowstopping grate. Manufactured from galvanized steel, connection made in the TOX technology.
- Used as a mounting element of a snowstopping grate on sloping roofs covered with profiled metal roof tile of module 400/20 mm.



Galvanized; RAL: 8004; 8017; 8019; 9005; 6020; 7016; 3009; 3004; 7024

5 pcs.



## FIX METAL FLAT

- Adapter for a snowstopping grate. Manufactured from galvanized steel, connection made in the TOX technology.
- Used as a mounting element of a snowstopping grate on sloping roofs covered with flat metal sheet finished with a standing seam.



Galvanized; RAL: 8004; 8017; 8019; 9005; 6020; 7016; 3009; 3004; 7024

5 pcs.



## CLIP

- The clip for snow-stopping pipe made from galvanized steel.
- Used as an element for connecting several grates into a row in an easy and durable way.



60 mm Galvanized; RAL: 8004; 8017; 8019; 9005; 6020; 7016; 3009; 3004; 7024

50 pcs.



## FIX METAL VENECJA

- Adapter for a snowstopping grate. Manufactured from galvanized steel, connection made in the TOX technology.
- Used as a mounting element of a snowstopping grate on sloping roofs covered with profiled metal roof tile of module VENECJA 350/35 mm.



Galvanized; RAL: 8004; 8017; 8019; 9005; 6020; 7016; 3009; 3004; 7024

5 pcs.



## FIX METAL FINNERA

- Adapter for a snowstopping grate. Manufactured from galvanized steel, connection made in the TOX technology.
- Used as a mounting element of a snowstopping grate on sloping roofs covered with profiled metal roof tile of module FINNERA 330/30 mm.



Galvanized; RAL: 8004; 8017; 8019; 9005; 6020; 7016; 3009; 3004; 7024

5 pcs.

### › Eurovent® FIX METAL FLAT

- 1 Eurovent® FIX METAL FLAT
- 2 Eurovent® SNOWSTOPPER
- 3 Eurovent® METALLIC
- 4 Sarking
- 5 Thermal insulation
- 6 Flat sheet metal

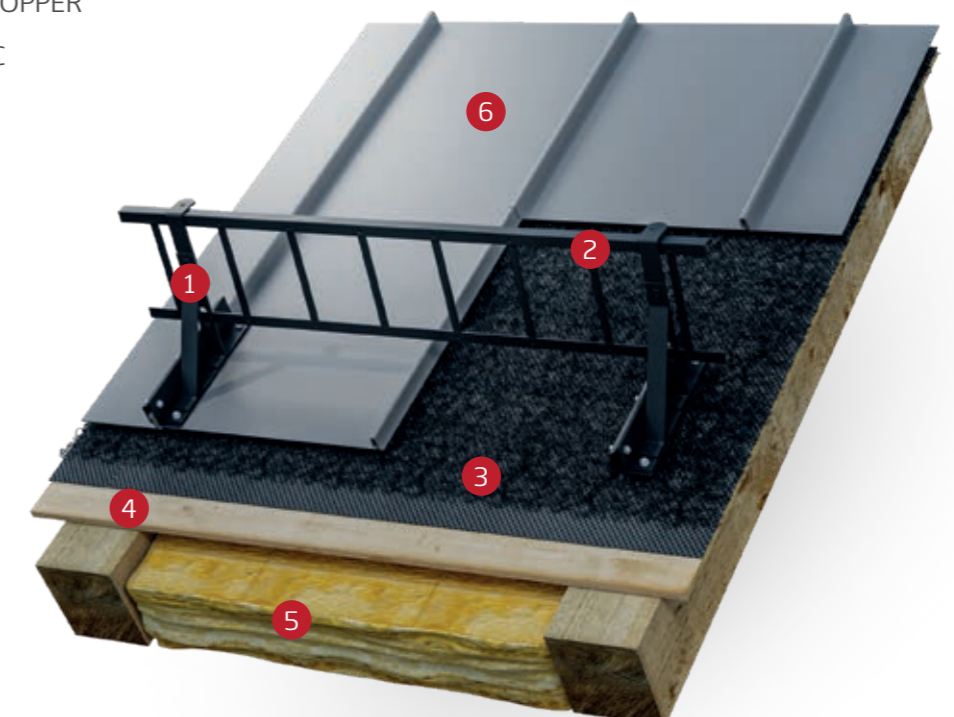





## TUBE

- Snow-stopping pipe made from galvanized steel.
- Designed for use as a anti-snow protection element on sloping roofs. It also prevents against movements of mass quantities of snow.



2,0 m



Galvanized; RAL: 8004; 8017; 8019; 9005; 6020; 7016; 8012; 3004; 7024



5 pcs.



## FIX TUBE UNI

- Adapter for a snow-stopping pipe, manufactured from galvanized steel.
- Universal fixing of a snow-stopping pipe to the roof covering. Mounted to flat roof slopes of an angle ranging from 15 to 60 degrees.



Galvanized; RAL: 8004; 8017; 8019; 9005; 6020; 7016; 8012; 3004; 7024



5 pcs.



## FIX TUBE BIBER

- Adapter for a snow-stopping pipe, manufactured from galvanized steel.
- A mounting element of a snow-stopping pipe to roof slopes of an angle ranging from 15 to 60 degrees, covered with ceramic roof tiles-beaver-tail roof tiles.



Galvanized; RAL: 8004; 8017; 8019; 9005; 6020; 7016; 8012; 3004; 7024



5 pcs.



## FIX TUBE METAL 350

- Adapter for a snow-stopping pipe, manufactured from galvanized steel.
- A mounting element of a snowstopping pipe on sloping roofs covered with profiled metal roof tile of module 350/20 mm.



Galvanized; RAL: 8004; 8017; 8019; 9005; 6020; 7016; 8012; 3004; 7024



5 pcs.



## FIX TUBE DB-DC SHORT

- Adapter for a snow-stopping pipe, manufactured from galvanized steel.
- A mounting element of a snow-stopping pipe to roof slopes of an angle ranging from 15 to 60 degrees, covered with cement or ceramic roof tiles requiring over 10 pcs./sqm.



Galvanized; RAL: 8004; 8017; 8019; 9005; 6020; 7016; 8012; 3004; 7024



5 pcs.



## FIX TUBE DB-DC LONG

- Adapter for a snow-stopping pipe, manufactured from galvanized steel.
- A mounting element of a snow-stopping pipe to roof slopes of an angle ranging from 15 to 60 degrees, covered with cement or ceramic large sized roof tiles requiring less than 10 pcs./sqm.



Galvanized; RAL: 8004; 8017; 8019; 9005; 6020; 7016; 8012; 3004; 7024



5 pcs.



## FIX TUBE METAL FLAT

- Adapter for a snow-stopping pipe, manufactured from galvanized steel.
- Used as a mounting element of a snow-stopping pipe on sloping roofs covered with flat metal sheet finished with a standing seam.



Galvanized; RAL: 8004; 8017; 8019; 9005; 6020; 7016; 8012; 3004; 7024



5 pcs.



## FIX TUBE METAL 400

- Adapter for a snow-stopping pipe, manufactured from galvanized steel.
- A mounting element of a snowstopping pipe on sloping roofs covered with profiled metal roof tile of module 400/20 mm.



Galvanized; RAL: 8004; 8017; 8019; 9005; 6020; 7016; 8012; 3004; 7024



5 pcs.





## FIX TUBE METAL VENECJA

- Adapter for a snow-stopping pipe, manufactured from galvanized steel.
- A mounting element of a snowstopping pipe on sloping roofs covered with profiled metal roof tile of module VENECJA 350/35 mm.



Galvanized; RAL: 8004; 8017; 8019; 9005; 6020; 7016; 8012; 3004; 7024

5 pcs.



## FIX TUBE METAL FINNERA

- Adapter for a snow-stopping pipe, manufactured from galvanized steel.
- A mounting element of a snowstopping pipe on sloping roofs covered with profiled metal roof tile of module FINNERA 330/30 mm.



Galvanized; RAL: 8004; 8017; 8019; 9005; 6020; 7016; 8012; 3004; 7024

5 pcs.



## END TUBE

- The end of snow-stopping pipes made of plastic.
- Designed for sealing the snow-stopping pipes at their ends.



RAL: 9005

10 pcs.



## CLIP TUBE

- Clip for snow-stopping pipe made from plastic.
- Used as an element enabling efficient connection of two snow-stopping pipes into a line.



RAL: 9005

10 pcs.



## FIX TUBE METAL JANOSIK

- Adapter for a snow-stopping pipe, manufactured from galvanized steel.
- A mounting element of a snowstopping pipe on sloping roofs covered with profiled metal roof tile of module JANOSIK 380/35 mm.



Galvanized; RAL: 8004; 8017; 8019; 9005; 6020; 7016; 8012; 3004; 7024

5 pcs.



## FIX TUBE METAL GERMANIA

- Adapter for a snow-stopping pipe, manufactured from galvanized steel.
- A mounting element of a snowstopping pipe on sloping roofs covered with profiled metal roof tile of module GERMANIA SIMETRIC 350/30 mm.



Galvanized; RAL: 8004; 8017; 8019; 9005; 6020; 7016; 8012; 3004; 7024

5 pcs.

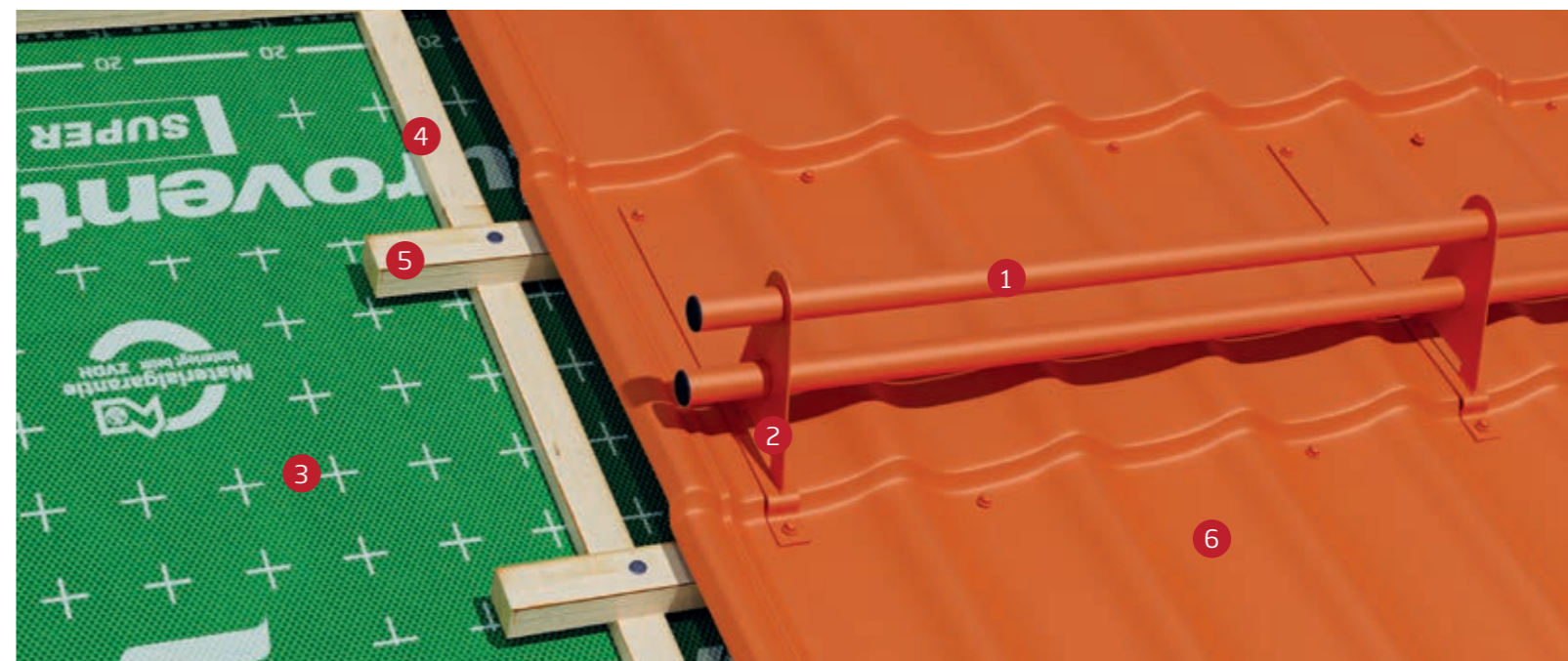

### › Application of a Eurovent® TUBE SET METAL 400

- |                                |                   |              |
|--------------------------------|-------------------|--------------|
| 1 Eurovent® TUBE               | 3 Eurovent® SUPER | 5 Batten     |
| 2 Eurovent® FIX TUBE METAL 400 | 4 Counter batten  | 6 Roof cover |





## BLOCK UNI

- Grip for snow-stopping log manufactured from galvanized steel.
- A mounting element enabling efficient installation for firmer snow-stopping logs on sloping roofs of an angle ranging from 15 to 60 degrees.



Galvanized; RAL: 8004; 8017; 8019; 9005; 6020; 7016; 3009; 3004; 7024

10 pcs.

## EUROVENT® FIX METAL, EUROVENT® FIX TUBE METAL – TECHNICAL DATA

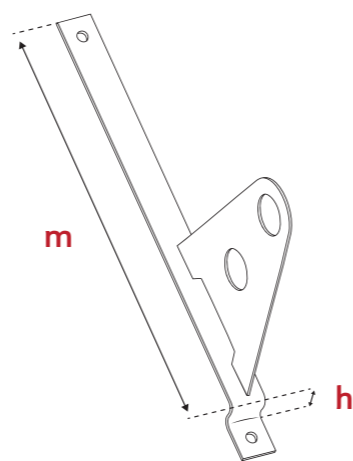
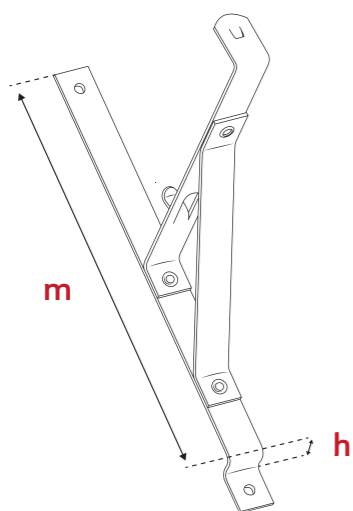

FIX	Module length „m” [mm]	Embossing height „h” [mm]
FIX METAL 350   FIX TUBE METAL 350	350	20
FIX METAL 400   FIX TUBE METAL 400	400	20
FIX METAL FINNERA   FIX TUBE METAL FINNERA	330	30
FIX METAL VENECA   FIX TUBE METAL VENECA	350	35
FIX METAL PANEL   FIX TUBE METAL JANOSIK	370   380	35
FIX TUBE METAL GERMANIA	350	30

## METAL ROOFS – PRODUCERS LIST

Metal roof tiles types	Module „m”	Producer	FIX METAL	FIX TUBE METAL
<b>A</b> ADAMANTE	350	RUUKKI	FIX METAL VENECA	FIX TUBE METAL VENECA
ALLANO	350	BRATEX	FIX METAL VENECA	FIX TUBE METAL VENECA
AMALFI PLUS	350	BLACHDOM PLUS	FIX METAL VENECA	FIX TUBE METAL VENECA
<b>B</b> BELLA SARA	350	BUDMAT	FIX METAL VENECA	FIX TUBE METAL VENECA
BONA PLUS	350	BLACHDOM PLUS	FIX METAL 350	FIX TUBE METAL 350
BONA PLUS	400	BLACHDOM PLUS	FIX METAL 400	FIX TUBE METAL 400
<b>C</b> CENTRO	350	BRATEX	FIX METAL VENECA	FIX TUBE METAL VENECA
<b>D</b> DIAMENT ECO PLUS	350	BLACHOTRAPEZ	FIX METAL 350	FIX TUBE METAL 350
DIAMENT ECO PLUS	400	BLACHOTRAPEZ	FIX METAL 400	FIX TUBE METAL 400
<b>F</b> FINEZJA MAX	350	FLORIAN	FIX METAL VENECA	FIX TUBE METAL VENECA
FINNERA	330	RUUKKI	FIX METAL FINNERA	FIX TUBE METAL FINNERA
FLORINA	400	FLORIAN	FIX METAL 400	FIX TUBE METAL 400
FRIGGE	350	RUUKKI	FIX METAL VENECA	FIX TUBE METAL VENECA
<b>G</b> GERMAN SIMETRIC	350	BLACHOTRAPEZ	FIX METAL GERMANIA	FIX TUBE METAL GERMANIA
GRYF	350	PRUSZYŃSKI	FIX METAL VENECA	FIX TUBE METAL VENECA
<b>I</b> IMPERIA PLUS	350	BLACHDOM PLUS	FIX METAL 350	FIX TUBE METAL 350
IMPERIA PLUS	400	BLACHDOM PLUS	FIX METAL 400	FIX TUBE METAL 400
<b>J</b> JANOSIK	380	BLACHOTRAPEZ	FIX METAL PANEL	FIX TUBE METAL JANOSIK
<b>K</b> KINGA	350	FLORIAN	FIX METAL 350	FIX TUBE METAL 350
KINGA	400	FLORIAN	FIX METAL 400	FIX TUBE METAL 400
KINGAS	350	BLACHOTRAPEZ	FIX METAL 350	FIX TUBE METAL 350
KINGAS	400	BLACHOTRAPEZ	FIX METAL 400	FIX TUBE METAL 400
KINGAS 15	350	BLACHOTRAPEZ	FIX METAL 350	FIX TUBE METAL 350
KINGAS 15	400	BLACHOTRAPEZ	FIX METAL 400	FIX TUBE METAL 400
KINGAS ECO PLUS	350	BLACHOTRAPEZ	FIX METAL 350	FIX TUBE METAL 350
KLARA	350	FLORIAN	FIX METAL 350	FIX TUBE METAL 350
KORONA PLUS	350	BLACHDOM PLUS	FIX METAL 350	FIX TUBE METAL 350
KORONA PLUS	400	BLACHDOM PLUS	FIX METAL 400	FIX TUBE METAL 400
<b>L</b> LIDIA MAX	350	FLORIAN	FIX METAL VENECA	FIX TUBE METAL VENECA
LOARA	350	PRUSZYŃSKI	FIX METAL VENECA	FIX TUBE METAL VENECA
<b>M</b> MAJA MAX	350	FLORIAN	FIX METAL VENECA	FIX TUBE METAL VENECA
MONTERREY FEB FORMA	350	RUUKKI	FIX METAL VENECA	FIX TUBE METAL VENECA
MURANO	350	BUDMAT	FIX METAL VENECA	FIX TUBE METAL VENECA
MUSTANG	350	BLACHPOL	FIX METAL VENECA	FIX TUBE METAL VENECA
<b>O</b> OPTIMA ARAD	350	PRUSZYŃSKI	FIX METAL VENECA	FIX TUBE METAL VENECA



## METAL ROOFS - PRODUCERS LIST

Metal roof tiles types	Module „m”	Producer	FIX METAL	FIX TUBE METAL
<b>P</b> PERŁA PLUS	350	BLACHDOM PLUS	FIX METAL 350	FIX TUBE METAL 350
	400	BLACHDOM PLUS	FIX METAL 400	FIX TUBE METAL 400
	350	BRATEX	FIX METAL 350	FIX TUBE METAL 350
<b>R</b> RIALTO	350	BUDMAT	FIX METAL VENECJA	FIX TUBE METAL VENECJA
	350	FLORIAN	FIX METAL VENECJA	FIX TUBE METAL VENECJA
	350	FLORIAN	FIX METAL 350	FIX TUBE METAL 350
	400	FLORIAN	FIX METAL 400	FIX TUBE METAL 400
	350	PRUSZYŃSKI	FIX METAL 350	FIX TUBE METAL 350
	400	PRUSZYŃSKI	FIX METAL 400	FIX TUBE METAL 400
<b>S</b> SOFIA	350	FLORIAN	FIX METAL 350	FIX TUBE METAL 350
	400	FLORIAN	FIX METAL 400	FIX TUBE METAL 400
	350	PRUSZYŃSKI	FIX METAL 350	FIX TUBE METAL 350
	400	PRUSZYŃSKI	FIX METAL 400	FIX TUBE METAL 400
<b>T</b> TALIA	350	BLACHOTRAPEZ	FIX METAL VENECJA	FIX TUBE METAL VENECJA
	350	FLORIAN	FIX METAL VENECJA	FIX TUBE METAL VENECJA
	350	BLACHODACH	FIX METAL 350	FIX TUBE METAL 350
<b>V</b> VELLO	350	BRATEX	FIX METAL VENECJA	FIX TUBE METAL VENECJA
	350	BUDMAT	FIX METAL VENECJA	FIX TUBE METAL VENECJA

## ROOF TILES - PRODUCERS LIST

Roof tile types	Producer	Coverage / sq.m	FIX	FIX TUBE
CELTYCKA	BRAAS	9,7 - 10,7 pcs.	FIX DB-DC	FIX TUBE DB-DC LONG
FIGARO 11	TONDACH	11,1 pcs.	FIX DB-DC	FIX TUBE DB-DC SHORT
GRANAT 13V	BRAAS	12,9 - 14,1 pcs.	FIX DB-DC	FIX TUBE DB-DC SHORT
HOLENDERKA 11	TONDACH	11,1 pcs.	FIX DB-DC	FIX TUBE DB-DC SHORT
KARPIÓWKA	KORAMIC	36 pcs.	FIX BIBER	FIX TUBE BIBER
	NELSKAMP	36 pcs.	FIX BIBER	FIX TUBE BIBER
	TONDACH	32 - 36 pcs.	FIX BIBER	FIX TUBE BIBER
MARSYLKA 11	KORAMIC	12,5 pcs.	FIX DB-DC	FIX TUBE DB-DC SHORT
	RÖBEN	9,4 - 9,9 pcs.	FIX DB-DC	FIX TUBE DB-DC LONG
NIBRA F10	NELSKAMP	10,0 pcs.	FIX DB-DC	FIX TUBE DB-DC LONG
	NELSKAMP	7,0 pcs.	FIX DB-DC	FIX TUBE DB-DC LONG
	NELSKAMP	9,9 - 10,4 pcs.	FIX DB-DC	FIX TUBE DB-DC LONG
	NELSKAMP	9,5 - 13,3 pcs.	FIX DB-DC	FIX TUBE DB-DC SHORT
OPAL	BRAAS	39,1 - 44,5 pcs.	FIX BIBER	FIX TUBE BIBER
	RÖBEN	10,1 - 11,2 pcs.	FIX DB-DC	FIX TUBE DB-DC SHORT
PIEMONTE	KORAMIC	9,9 pcs.	FIX DB-DC	FIX TUBE DB-DC LONG
	PŁASKA OREA 9			
RENEANSOWA ALEGRA 9	KORAMIC	9,3 pcs.	FIX DB-DC	FIX TUBE DB-DC LONG
REŃSKA COSMO 11	KORAMIC	11,2 pcs.	FIX DB-DC	FIX TUBE DB-DC SHORT
ROMAŃSKA AERLOX	BRAAS	9,7 - 10,7 pcs.	FIX DB-DC	FIX TUBE DB-DC SHORT
RUBIN 9 V	BRAAS	9,4 - 10,1 pcs.	FIX DB-DC	FIX TUBE DB-DC SHORT
RUBIN 13 V	BRAAS	12,3 - 13,5 pcs.	FIX DB-DC	FIX TUBE DB-DC LONG
STODO 11	TONDACH	12,0 pcs.	FIX DB-DC	FIX TUBE DB-DC SHORT
TEVIVA	BRAAS	9,8 - 10,7 pcs.	FIX DB-DC	FIX TUBE DB-DC SHORT
TOPAS 11 V	BRAAS	11,5 - 13,6 pcs.	FIX DB-DC	FIX TUBE DB-DC LONG
TOPAS 13 V	BRAAS	12,9 - 14,5 pcs.	FIX DB-DC	FIX TUBE DB-DC LONG
TURMALIN	BRAAS	11,0 - 11,7 pcs.	FIX DB-DC	FIX TUBE DB-DC LONG





# Snow Zones

In accordance with the regulations included in the Polish Standard PN-EN 1991-1-3, owners of buildings are obliged to ensure security to the buildings users, as well as to outsiders as far as the snow sliding down from roof slopes is concerned. The aforementioned standard precisely states the rules and the number of protecting elements which are supposed to be installed on a roof slope.



## Snow-stopping grates and logs

The position of snow-stopping grates and logs brackets for particular zones:



Two rows of snow-stopping grates are recommended to be positioned in case of roofs which slope length is bigger than 6,5 m.

For roofs which angle is bigger than 40° and the slope length bigger than 8 m, two rows of snow breakers are recommended to be installed.

## Snowstop – snow breaker

Snowstops are an alternative solution in terms of snow protection for snow-stopping grates and logs. In order to make their work effective, it is recommended to dispose them on the entire roof slope surface, while their disposal and quantity depend on a roof angle and the snow zone in which a particular building is located. The table presented below shows a precise number of snowstops for 1 m<sup>2</sup> of a roof slope in dependence on an angle and the load value of snow on the roof.

The formula for calculation of roof loading with snow is applied when the value (s) is not provided in a construction project.

$$S = Q_K \cdot C \cdot Y_1 \text{ [kN/m}^2\text{]}$$

Where:

$Q_K$  – Load value of snow on the ground:

- zone 1            0,7 kN/m<sup>2</sup>
- zone 2            0,9 kN/m<sup>2</sup>
- zone 3            1,2 kN/m<sup>2</sup>
- zone 4            1,6 kN/m<sup>2</sup>
- zone 5            ≥ 2,0 kN/m<sup>2</sup>

$Y_1$  – factor of safety = 1,5

$C$  – factor of the roof shape

The formula for calculation of a factor of the roof shape ( $C$ ).

1. Pent roof and gable roof:

$$C_1(\alpha) = \begin{cases} 0,8 \\ 0,8 \left( \frac{60 - \alpha}{30} \right) \\ 0,0 \end{cases}$$

2. Gable roof for zones of bigger load or zones 4 and 5:

$$C_2(\alpha) = \begin{cases} 0,8 \\ 0,8 + 0,4 \left( \frac{\alpha - 15}{15} \right) \\ 1,2 \left( \frac{60 - \alpha}{30} \right) \\ 0,0 \end{cases}$$

1. roof angle:

$\alpha \leq 30^\circ$

$30^\circ < \alpha \leq 60^\circ$

$\alpha > 60^\circ$

2. roof angle:

$\alpha \leq 15^\circ$

$15^\circ < \alpha \leq 30^\circ$

$30^\circ < \alpha \leq 60^\circ$

$\alpha > 60^\circ$

Number of snowstops (pieces/m<sup>2</sup>)

		load value of snow on the roof S (kN/m <sup>2</sup> ).										
		S ≤	1,00	2,00	3,00	4,00	5,00	6,00	7,00	8,00	9,00	10,00
roof slope angle	20°	2,0	2,1	2,1	2,2	2,2	2,5	2,8	3,3	3,5	3,8	4,6
	25°	2,1	2,2	2,2	2,3	2,5	2,7	3,1	3,5	4,0	4,4	5,2
	30°	2,1	2,2	2,2	2,4	2,8	3,2	3,8	4,2	4,6	4,9	5,5
	35°	2,2	2,3	2,3	2,5	2,9	3,3	3,9	4,4	4,6	5,2	6,2
	40°	2,3	2,4	2,4	2,6	3,0	3,4	4,2	4,5	5,0	5,3	6,8
	45°	2,5	2,6	2,7	2,8	3,1	3,6	4,4	4,9	5,2	5,5	7,0
	50°	3,1	3,3	3,6	4,0	4,3	4,7	5,2	5,6	5,9	6,1	7,1
	55°	3,2	3,4	3,7	4,1	4,4	4,8	5,4	5,8	6,0	6,3	7,2
	60°	3,3	3,8	4,2	4,4	4,7	5,1	5,4	6,0	6,4	6,8	7,4



## METAL ROOFS

The table indicates the suggested number of supports on metal tile and flat roof covers depending on the angle of slope and rafter length. pcs./ snowstopping grate.

≤ angle (°)	Rafter length (m)									
	5	6	7	8	9	10	11	12	13	14
15°	3	3	3	3	3	4	4	4	5	5
20°	3	3	3	4	4	5	5	5	6	6
25°	3	4	4	5	5	5	6	6	2 rows/4	6
30°	4	4	5	5	6	6	2 rows/4	2 rows/4	2 rows/5	2 rows/6
35°	4	5	5	6	6	2 rows/4	2 rows/5	2 rows/5	2 rows/6	2 rows/6
40°	5	5	6	6	2 rows/4	2 rows/5	2 rows/5	2 rows/6	2 rows/6	3 rows/6
45°	5	5	6	2 rows/4	2 rows/5	2 rows/5	2 rows/6	3 rows/6	3 rows/6	3 rows/6
50°	5	6	6	2 rows/4	2 rows/5	2 rows/6	3 rows/6	3 rows/6	3 rows/6	3 rows/6
55°	5	6	2 rows/4	2 rows/5	2 rows/6	2 rows/6	3 rows/6	3 rows/6	3 rows/6	3 rows/6
60°	6	6	2 rows/4	2 rows/5	2 rows/6	3 rows/6	3 rows/6	3 rows/6	3 rows/6	3 rows/6

\*The final decision about the scope of snow protection should be made by the site manager with reference to the architectural design.

## CERAMIC & CONCRETE ROOF TILES

The table indicates the suggested number of supports on ceramic and concrete tile covers depending on the angle of slope and rafter length. pcs./ snowstopping grate.

≤ angle (°)	Rafter length (m)									
	5	6	7	8	9	10	11	12	13	14
15°	3	3	3	3	3	3	3	4	4	4
20°	3	3	3	3	4	4	4	6	6	6
25°	3	3	4	4	4	6	6	6	6	6
30°	3	4	4	4	6	6	6	2 rows/4	2 rows/6	2 rows/6
35°	4	4	6	6	6	6	2 rows/4	2 rows/6	2 rows/6	2 rows/6
40°	4	4	6	6	6	2 rows/4	2 rows/6	2 rows/6	3 rows/6	3 rows/6
45°	4	6	6	6	2 rows/4	2 rows/6	2 rows/6	3 rows/6	3 rows/6	3 rows/6
50°	4	6	6	2 rows/4	2 rows/6	2 rows/6	3 rows/6	3 rows/6	3 rows/6	3 rows/6
55°	6	6	6	2 rows/6	2 rows/6	2 rows/6	3 rows/6	3 rows/6	3 rows/6	3 rows/6
60°	6	6	2 rows/4	2 rows/6	2 rows/6	3 rows/6	3 rows/6	3 rows/6	3 rows/6	3 rows/6

\*The final decision about the scope of snow protection should be made by the site manager with reference to the architectural design.





# SNOWSTOP

Snowstops used as an element breaking mass quantities of snow sliding down from roof slopes to the eaves area. Made from galvanized steel, lacquered with a polyester paint. Available in a dozen of models dedicated for different types of roof coverings.



8004; 8019; 8017;  
9005; 7016; 8012\*



100 pcs.



3 000 pcs.



**UNI**  
for flat roof coverings  
Models SHORT, LONG



**DB**  
BRAAS, IBF, EURONIT,  
JOPEK – BEAVER-TILE,  
NELSKAMP, KORAMIC,  
CREATON VIVA, RUPP TOPAS



**DC-1**  
TONDACH HRANICE 11,  
CREATON MZ23, KORAMIC 32,  
RÖBEN MONZA PLUS,  
RUPP TARMAUTE



**DC-2**  
TONDACH ROMAŃSKA 12,  
CREATON HARMONIA NEU,  
BRAAS / RUPP SIRIUS 13,  
KORAMIC E80, JAKOBI D10,  
RÖBEN FLEMING, RÖBEN  
BORNHOLM  
Models: SHORT; LONG



**DC-3**  
TONDACH: FRANCUSKA 12,  
FALCOVKA, MARSYLKA 12,  
RUPP RUBIN, CREATON:  
DOMINO, RATIO NEU,  
PIATTA, BRAAS ARMER 12V,  
KORAMIC ALEGRA 89,  
BOGEN INNOVO 12



**DC-4**  
TONDACH: FRANCUSKA 14,  
MARSYLKA 14



**METAL**  
metal roof covering



**DC-5**  
TONDACH ROMAŃSKA L15,  
CREATON FUTURA



**DC-6**  
TONDACH STODO,  
JIRCANKA



**DC-7**  
CREATON: PREMION



**DC-8**  
CREATON HARMONICA



**DC-9**  
CREATON BALANCE

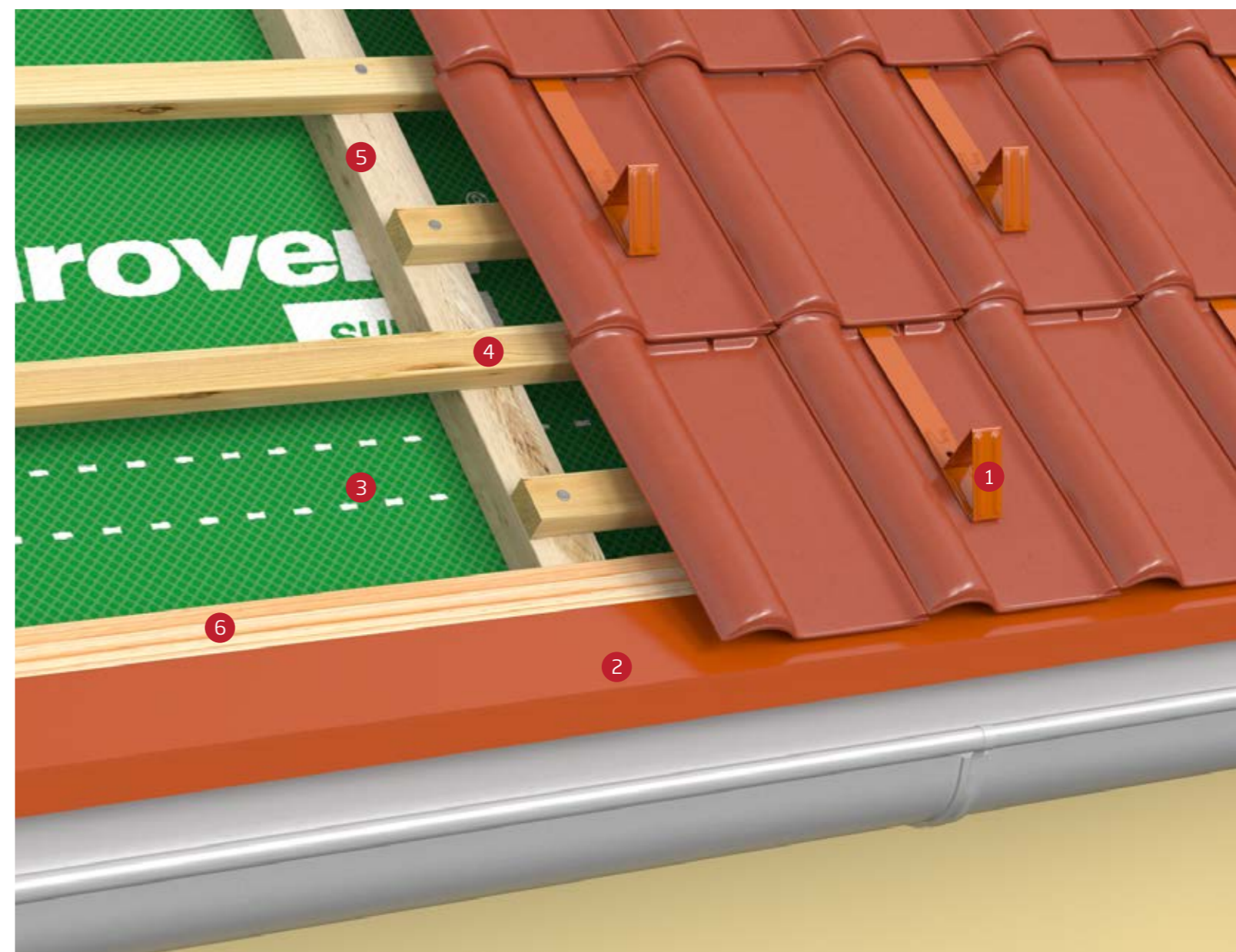

## › Application of a snow-breaker Eurovent® SNOWSTOP

- 1 Eurovent® SNOWSTOP
- 2 Eurovent® EAVES PLANK
- 3 Eurovent® SUPER
- 4 Batten
- 5 Counter batten
- 6 Eaves board

\* on order



## SNOWSTOPPER SET

The system of snow-stopping protection, set from a snow-stopping grate SNOWSTOPPER, adapters FIX and clips CLIP. Constitutes efficient protection against snow movements down from roof slopes of an angle ranging from 15 to 60 degrees.

	1,0 m; 2,0 m; 3,0 m
	Galvanized; RAL: 8004; 8017; 8019; 6020; 9005; 7016; 3009; 7024; 3004
	1 set
	12 sets



**BIBER**  
for beaver tile-roof tiles.



**DB-DC**  
for cement and ceramic roof tiles.



**METAL FLAT**  
for flat metal coverings finished with a standing seam.



**UNI**  
for flat roof coverings flat coverings, e.g. bituminous shingles.



**METAL PANEL**  
for panel metal sheet of module 370/35 mm. Metro SHAKE II, Pruszyński REGLE, Novatik PREMIUM, Novatik HARNAŚ, Blachotrapez JANOSIK.



**METAL 350**  
for profiled metal roof tile of module 350/20 mm.



**METAL 400,**  
for profiled metal roof tile of module 400/20 mm.



**METAL FINNERA**  
for profiled metal roof tile of module FINNERA 330/30 mm.



**METAL VENECA**  
for profiled metal roof tile of module VENECA 350/35 mm.

### › Eurovent® SNOWSTOPPER SET DB-DC

- 1 Eurovent® FIX DB-DC
- 2 Eurovent® SNOWSTOPPER
- 3 Eurovent® XSTRONG
- 4 Eurovent® PUR
- 5 Additional batten
- 6 Thermal insulation
- 7 Roof tile







## › Roof safety

The roof traffic system guarantees safe traffic in the roof area and enables easy chimney works. The offered brackets make the installation possible on every kind of roof covering.

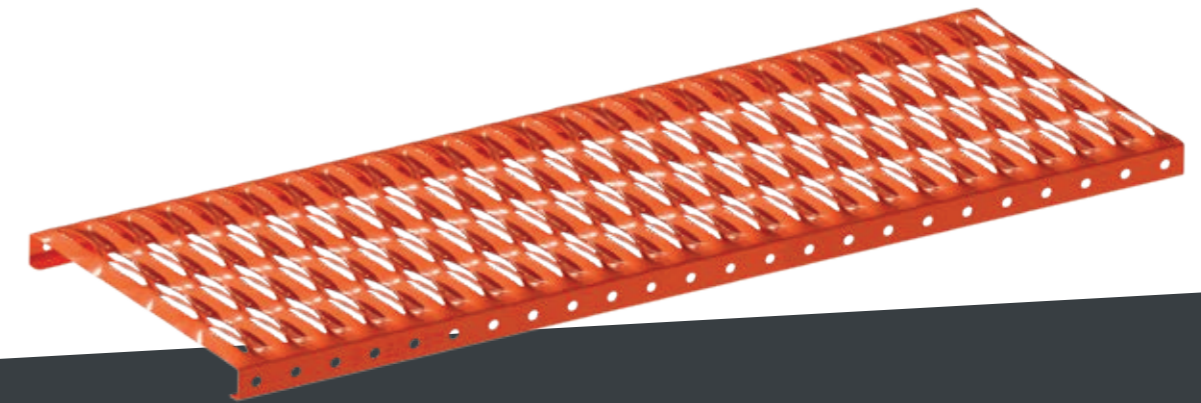

### PLATFORM

- Chimney bench manufactured from galvanized steel.
- Used as a roof communication element to enable safe foot traffic on the roof slope in the chimney area. The product features anti-slip corrugations.
- Mounted on the roof covering in conjunction with the GRIP bracket and the SUPPORT adapter.



0,4 m; 0,6 m; 0,8 m;  
1,0 m; 2,0 m; 3,0 m\*



Galvanized; RAL: 8004;  
8017; 8019; 9005; 6020;  
7016; 8012; 3004; 7024



4 pcs.

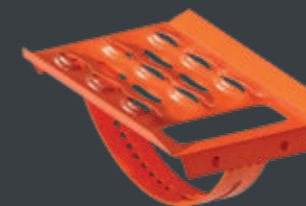

### STEP

- Chimney Step made from galvanized steel.
- Used as a roof communication element to enable safe foot traffic on the roof slope.
- Mounted on the roof covering in conjunction with the SUPPORT adapter.



170 mm  
x 250 mm



Galvanized; RAL: 8004; 8017; 8019;  
9005; 6020; 7016; 8012; 3004; 7024



10 pcs.



### GRIP

- Universal grip made from galvanized steel.
- An element that enables connecting a chimney bench with an adapter mounted directly on the roof covering.



Galvanized; RAL: 8004; 8017; 8019;  
9005; 6020; 7016; 8012; 3004; 7024



10 pcs.

\* on order





## LINK

- Roof platform link manufactured from galvanized steel.
- Used as a roof communication element which enables connecting chimney platforms into a row.
- Offered in a set with mounting screws.



180 mm



Galvanized; RAL: 8004; 8017; 8019; 9005; 6020; 7016; 8012; 3004; 7024



10 pcs.



## SUPPORT UNI

- One-piece adapter of a chimney bench bracket made from galvanized steel.
- An element that enables connecting a chimney bench bracket or a chimney step bracket on flat roof coverings.



Galvanized; RAL: 8004; 8017; 8019; 9005; 6020; 7016; 3009; 3004; 7024



10 pcs.



## SUPPORT DB-DC SHORT

- One-piece adapter of a chimney bench made from galvanized steel with additional PUR sealing.
- An element that enables connecting a chimney bench bracket or a chimney step bracket on profiled roofs covered with cement or ceramic roof tiles requiring over 10 pcs./sqm.



Galvanized; RAL: 8004; 8017; 8019; 9005; 6020; 7016; 3009; 3004; 7024



10 pcs.



## SUPPORT DB-DC LONG

- One-piece adapter of a chimney bench made from galvanized steel with additional PUR sealing.
- An element that enables connecting a chimney bench bracket or a chimney step bracket on profiled roofs covered with cement or ceramic large sized roof tiles requiring less than 10 pcs./sqm.



Galvanized; RAL: 8004; 8017; 8019; 9005; 6020; 7016; 3009; 3004; 7024



10 pcs.

### › Eurovent® PLATFORM SET DB-DC – Ceramic roof tile

- 1 Eurovent® PLATFORM
- 2 Eurovent® GRIP
- 3 Eurovent® SUPPORT DB-DC LONG
- 4 Eurovent® SUPER
- 5 Eurovent® PUR
- 6 Thermal insulation
- 7 Roof tile



## SUPPORT DB-DC WEST

- One-piece adapter made from galvanized steel with additional EPDM sealing.
- An element that enables connecting a chimney bench bracket or a chimney step bracket on roofs covered with cement or ceramic roof tiles.



Galvanized; RAL: 8004; 8017; 8019; 9005; 6020; 7016; 3009; 3004; 7024



10 pcs.



## SUPPORT BIBER WEST

- One-piece adapter made from galvanized steel with an additional PUR sealing.
- An element that enables connecting a chimney bench bracket or a chimney step bracket on roofs covered with flat ceramic roof tiles, called as beaver-tiles



Galvanized; RAL: 8004; 8017; 8019; 9005; 6020; 7016; 8012; 3004; 7024



10 pcs.





## SUPPORT METAL DECRA

- One-piece adapter of a chimney bench made from galvanized steel.
- An element that enables installation of a chimney bench or a step on the roofs covered with metal sheets of module DECRA 350/20 mm; DECRA 350/30 mm; DECRA 350/35 mm.



Ocynk; RAL: 8004; 8017; 8019; 9005; 6020; 7016; 8012; 3004; 7024

10 pcs.

## EUROVENT® SUPPORT METAL DECRA - MODELES OF SUPPORT

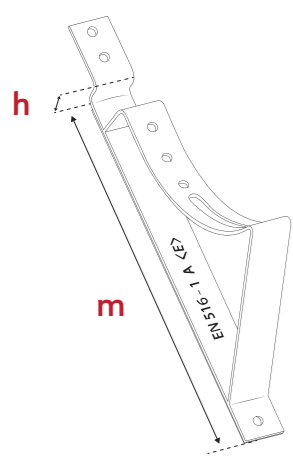

STANDARD 350/20

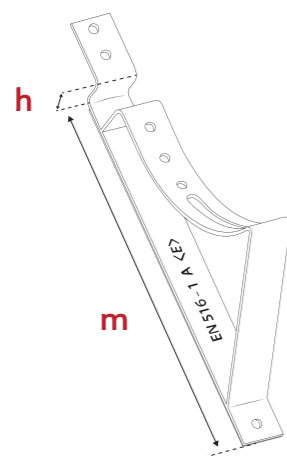

TYSENIA 350/30

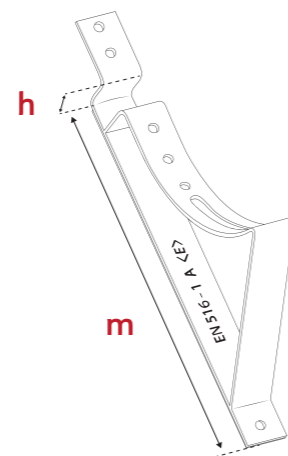

SAVANNA 350/35

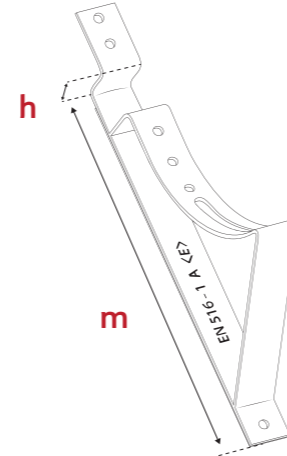

JANOSIK 380/35

SUPPORT METAL DECRA	Module length „m” [mm]	Embossing height „h” [mm]
Standard	350	20
Tysenia	350	30
Savanna	350	35
Janosik	380	35

## ASSEMBLY - SUPPORT METAL

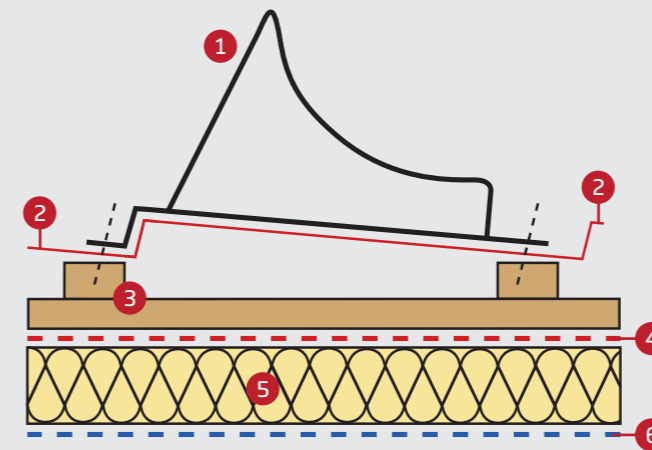

### METAL ROOF TILES - STANDARD ASSEMBLY

- 1 Eurovent® SUPPORT METAL
- 2 Classic metal roof tiles
- 3 Batten | Counter batten
- 4 Eurovent® Roof membrane
- 5 Thermal insulation
- 6 Eurovent® Vapour barrier membrane

### SUPPORT FOR STANDARD MONTAGE

- SUPPORT METAL 350
- SUPPORT METAL 400
- SUPPORT METAL VENECJA
- SUPPORT METAL FINNERA
- SUPPORT METAL GERMANIA

### METAL ROOF TILES - DECRA TYPE ASSEMBLY

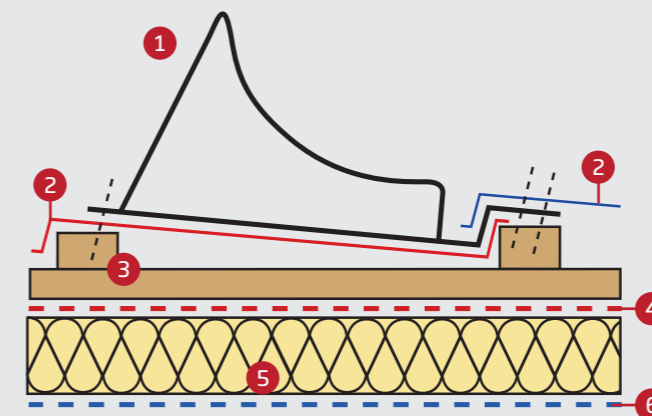

- 1 Eurovent® SUPPORT METAL
- 2 Modular metal roof tiles
- 3 Batten | Counter batten
- 4 Eurovent® Roof membrane
- 5 Thermal insulation
- 6 Eurovent® Vapour barrier membrane

### SUPPORT FOR DECRA TYPE MONTAGE

- SUPPORT METAL DECRA STANDARD
- SUPPORT METAL DECRA TYSENIA
- SUPPORT METAL DECRA SAVANNA
- SUPPORT METAL JANOSIK





## SUPPORT METAL JANOSIK

- The adapter of a chimney bench bracket, made from galvanized steel.
- An element that enables installation of a chimney bench or a step on the roofs covered with profiled metal sheets of modules JANOSIK 380/35 mm. Blachotrapez JANOSIK.



Galvanized; RAL: 8004; 8017; 8019; 9005; 6020; 7016; 8012; 3004; 7024

10 pcs.



## SUPPORT METAL 350

- The adapter of a chimney bench bracket, made from galvanized steel.
- An element that enables installation of a chimney bench or a step on the roofs covered with profiled metal sheets of module 350/20 mm.



Galvanized; RAL: 8004; 8017; 8019; 9005; 6020; 7016; 8012; 3004; 7024

10 pcs.



## SUPPORT METAL FINNERA

- The adapter of a chimney bench bracket, made from galvanized steel.
- An element that enables installation of a chimney bench or a step on the roofs covered with profiled metal sheets of modules FINNERA 330/30 mm.



Galvanized; RAL: 8004; 8017; 8019; 9005; 6020; 7016; 8012; 3004; 7024

10 pcs.



## SUPPORT METAL GERMANIA

- The adapter of a chimney bench bracket, made from galvanized steel.
- An element that enables installation of a chimney bench or a step on the roofs covered with profiled metal sheets of modules GERMANIA SIMETRIC 350/30 mm.



Galvanized; RAL: 8004; 8017; 8019; 9005; 6020; 7016; 8012; 3004; 7024

10 pcs.



## SUPPORT METAL 400

- The adapter of a chimney bench bracket, made from galvanized steel.
- An element that enables installation of a chimney bench or a step on the roofs covered with profiled metal sheets of module 400/20 mm.



Galvanized; RAL: 8004; 8017; 8019; 9005; 6020; 7016; 8012; 3004; 7024

10 pcs.



## SUPPORT METAL VENECJA

- The adapter of a chimney bench bracket, made from galvanized steel.
- An element that enables installation of a chimney bench or a step on the roofs covered with profiled metal sheets of modules VENECJA 350/35 mm.



Galvanized; RAL: 8004; 8017; 8019; 9005; 6020; 7016; 8012; 3004; 7024

10 pcs.



## SUPPORT METAL FLAT

- Three-pieces adapter of a chimney bench bracket, made from galvanized steel.
- An element that enables installation of a chimney bench or a step on the roofs covered with a flat sheet, finished on a standing seam.



Galvanized; RAL: 8004; 8017; 8019; 9005; 6020; 7016; 8012; 3004; 7024

10 pcs.



## VISTA DUO

- Roof exit made of impregnated pine wood with combined double glass 15 mm thick, set in an aluminum profile.
- Equipped with two opening options.
- Suitable for non-insulated attics and roofs of an angle ranging from 15 to 60 degrees.



45 cm x 55 cm  
45 cm x 73 cm  
48 cm x 90 cm

RAL: 7043

others: 11 pcs.  
48 cm x 90 cm: 10 pcs.



## EUROVENT® SUPPORT METAL

### - TECHNICAL DATA

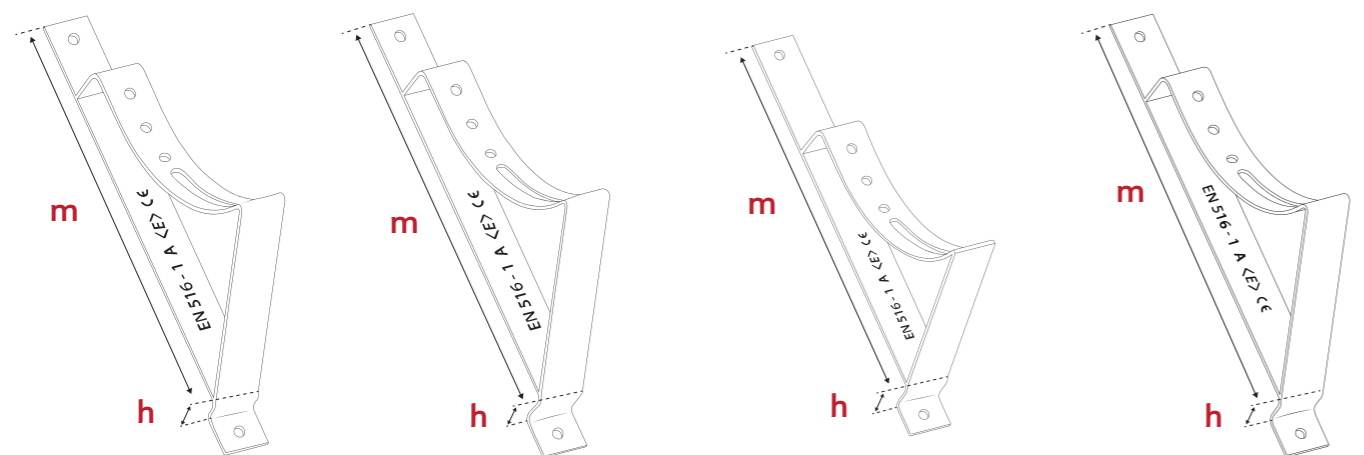

METAL 350/20  
METAL 400/20

VENECJA 350/35

FINNERA 330/30

GERMANIA 350/30

SUPPORT METAL	Module length „m” [mm]	Embossing height „h” [mm]
350	350	20
400	400	20
FINNERA	330	30
VENECJA	350	35
GERMANIA	350	30

## METAL ROOFS

### - PRODUCERS LIST

Metal roof tiles types	Module „m”	Producer	SUPPORT METAL
<b>A</b> ADAMANTE	350	RUUKKI	SUPPORT METAL VENECJA
ALLANO	350	BRATEX	SUPPORT METAL VENECJA
AMALFI PLUS	350	BLACHDOM PLUS	SUPPORT METAL VENECJA
<b>B</b> BELLA SARA	350	BUDMAT	SUPPORT METAL VENECJA
BONA PLUS	350	BLACHDOM PLUS	SUPPORT METAL 350
BONA PLUS	400	BLACHDOM PLUS	SUPPORT METAL 400
<b>C</b> CENTRO	350	BRATEX	SUPPORT METAL VENECJA
<b>D</b> DIAMENT ECO PLUS	350	BLACHOTRAPEZ	SUPPORT METAL 350
DIAMENT ECO PLUS	400	BLACHOTRAPEZ	SUPPORT METAL 400

## METAL ROOFS

### - PRODUCERS LIST

Metal roof tiles types	Module „m”	Producer	SUPPORT METAL
<b>F</b> FINEZJA MAX	350	FLORIAN	SUPPORT METAL VENECJA
FINNERA	330	RUUKKI	SUPPORT METAL FINNERA
FLORINA	400	FLORIAN	SUPPORT METAL 400
FRIGGE	350	RUUKKI	SUPPORT METAL VENECJA
<b>G</b> GERMANIA SIMETRIC	350	BLACHOTRAPEZ	SUPPORT METAL GERMANIA
GRYF	350	PRUSZYŃSKI	SUPPORT METAL VENECJA
<b>I</b> IMPERIA PLUS	350	BLACHDOM PLUS	SUPPORT METAL 350
IMPERIA PLUS	400	BLACHDOM PLUS	SUPPORT METAL 400
<b>J</b> JANOSIK	380	BLACHOTRAPEZ	SUPPORT METAL JANOSIK
<b>K</b> KINGA	350	FLORIAN	SUPPORT METAL 350
KINGA	400	FLORIAN	SUPPORT METAL 400
KINGAS	350	BLACHOTRAPEZ	SUPPORT METAL 350
KINGAS	400	BLACHOTRAPEZ	SUPPORT METAL 400
KINGAS 15	350	BLACHOTRAPEZ	SUPPORT METAL 350
KINGAS 15	400	BLACHOTRAPEZ	SUPPORT METAL 400
KINGAS ECO PLUS	350	BLACHOTRAPEZ	SUPPORT METAL 350
KLARA	350	FLORIAN	SUPPORT METAL 350
KORONA PLUS	350	BLACHDOM PLUS	SUPPORT METAL 350
KORONA PLUS	400	BLACHDOM PLUS	SUPPORT METAL 400
<b>L</b> LIDIA MAX	350	FLORIAN	SUPPORT METAL VENECJA
LOARA	350	PRUSZYŃSKI	SUPPORT METAL VENECJA
<b>M</b> MAJA MAX	350	FLORIAN	SUPPORT METAL VENECJA
MONTERREY FEB FORMA	350	RUUKKI	SUPPORT METAL VENECJA
MURANO	350	BUDMAT	SUPPORT METAL VENECJA
MUSTANG	350	BLACHPOL	SUPPORT METAL VENECJA
<b>O</b> OPTIMA ARAD	350	PRUSZYŃSKI	SUPPORT METAL VENECJA
<b>P</b> PERŁA PLUS	350	BLACHDOM PLUS	SUPPORT METAL 350
PERŁA PLUS	400	BLACHDOM PLUS	SUPPORT METAL 400
PLATINO	350	BRATEX	SUPPORT METAL 350
<b>R</b> RIALTO	350	BUDMAT	SUPPORT METAL VENECJA
ROZALIA MAX	350	FLORIAN	SUPPORT METAL VENECJA
RÓŻA	350	FLORIAN	SUPPORT METAL 350
RÓŻA	400	FLORIAN	SUPPORT METAL 400
RUBIN PLUS	350	PRUSZYŃSKI	SUPPORT METAL 350
RUBIN PLUS	400	PRUSZYŃSKI	SUPPORT METAL 400
SOFIA	350	FLORIAN	SUPPORT METAL 350
SOFIA	400	FLORIAN	SUPPORT METAL 400
SZAFIR	350	PRUSZYŃSKI	SUPPORT METAL 350



## METAL ROOFS - PRODUCERS LIST

Metal roof tiles types	Module „m”	Producer	SUPPORT METAL
<b>S</b> SZAFIR	400	PRUSZYŃSKI	SUPPORT METAL 400
<b>T</b> TALIA	350	BLACHOTRAPEZ	SUPPORT METAL VENECJA
TAMARA MAX	350	FLORIAN	SUPPORT METAL VENECJA
TWISTER	350	BLACHODACH	SUPPORT METAL 350
<b>V</b> VELLO	350	BRATEX	SUPPORT METAL VENECJA
VENECJA	350	BUDMAT	SUPPORT METAL VENECJA

## ROOF TILES - PRODUCERS LIST

Roof tile types	Producer	Coverage / sq.m	SUPPORT
CELTYCKA	BRAAS	9,7 - 10,7 pcs.	SUPPORT DB-DC LONG
FIGARO 11	TONDACH	11,1 pcs.	SUPPORT DB-DC SHORT
GRANAT 13V	BRAAS	12,9 - 14,1 pcs.	SUPPORT DB-DC SHORT
HOLENDERKA 11	TONDACH	11,1 pcs.	SUPPORT DB-DC SHORT
KARPIÓWKA	KORAMIC	36 pcs.	SUPPORT BIBER WEST
KARPIÓWKA	NELSKAMP	36 pcs.	SUPPORT BIBER WEST
KARPIÓWKA	TONDACH	32 - 36 pcs.	SUPPORT BIBER WEST
MARSYLKA 11	KORAMIC	12,5 pcs.	SUPPORT DB-DC SHORT
MONZA PLUS	RÖBEN	9,4 - 9,9 pcs.	SUPPORT DB-DC LONG
NIBRA F10	NELSKAMP	10,0 pcs.	SUPPORT DB-DC LONG
NIBRA F7	NELSKAMP	7,0 pcs.	SUPPORT DB-DC LONG
NIBRA G10	NELSKAMP	9,9 - 10,4 pcs.	SUPPORT DB-DC LONG
NIBRA R10	NELSKAMP	9,5 - 13,3 pcs.	SUPPORT DB-DC SHORT
OPAL	BRAAS	39,1 - 44,5 pcs.	SUPPORT BIBER WEST
PIEMONT	RÖBEN	10,1 - 11,2 pcs.	SUPPORT DB-DC SHORT
PŁASKA OREA 9	KORAMIC	9,9 pcs.	SUPPORT DB-DC LONG
RENEANSOWA ALEGRA 9	KORAMIC	9,3 pcs.	SUPPORT DB-DC LONG
REŃSKA COSMO 11	KORAMIC	11,2 pcs.	SUPPORT DB-DC SHORT
ROMAŃSKA AERLOX	BRAAS	9,7 - 10,7 pcs.	SUPPORT DB-DC LONG
RUBIN 9 V	BRAAS	9,4 - 10,1 pcs.	SUPPORT DB-DC LONG
RUBIN 13 V	BRAAS	12,3 - 13,5 pcs.	SUPPORT DB-DC SHORT
STODO 11	TONDACH	12,0 pcs.	SUPPORT DB-DC SHORT
TEVIVA	BRAAS	9,8 - 10,7 pcs.	SUPPORT DB-DC LONG
TOPAS 11 V	BRAAS	11,5 - 13,6 pcs.	SUPPORT DB-DC SHORT
TOPAS 13 V	BRAAS	12,9 - 14,5 pcs.	SUPPORT DB-DC SHORT
TURMALIN	BRAAS	11,0 - 11,7 pcs.	SUPPORT DB-DC SHORT





# PLATFORM SET

Chimney platform in a complete assembly set consisting of two adapters SUPPORT, two GRIP adapters, mounting screws and a one chimney bench PLATFORM. The elements made of galvanized steel form a complete system for safe traffic on the roof slope with an angle of 15° to 60°.



0,4 m; 0,6 m; 0,8 m



RAL: 8004; 8017; 8019;  
9005; 7016; 8012; 3004



1 set (2 x SUPPORT,  
2 x GRIP, 1 x PLATFORM)



0,4 m: 60 sets  
0,8 m: 40 sets

## › Eurovent® PLATFORM SET DB-DC – Ceramic roof tile

- 1 Eurovent® PLATFORM
- 3 Eurovent® GRIP
- 4 Eurovent® SUPPORT DB-DC LONG
- 5 Eurovent® SUPER
- 6 Eurovent® PUR
- 7 Additional batten
- 8 Thermal insulation
- 9 Roof tile

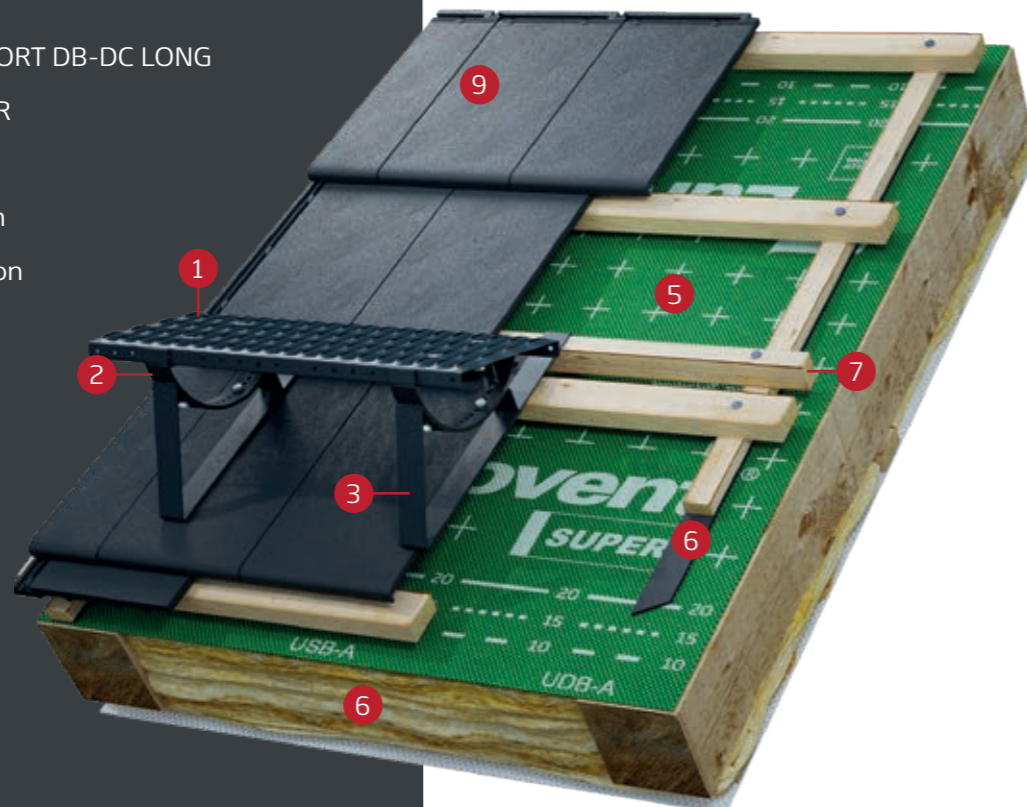

### UNI

for flat roof coverings,  
e.g. bituminous shingle.



### METAL FLAT

for metal flat roofs coverings  
finished on a standing seam.



### DB-DC SHORT

for interlocking roof tiles requiring over  
10 pcs./sqm and beaver-tail roof tiles  
laid in double-lap pattern.



### DB-DC LONG

for large sized interlocking roof tiles  
requiring less than 10 pcs./sqm.



### METAL 350

for metal roof covered with profiled  
metal sheets of the module 350/20 mm.



### METAL 400

for metal roof covered with profiled  
metal sheets of the module 400/20 mm.



### METAL VENECJA

for metal roof covered with profiled  
metal sheets of the module VENECJA  
350/35 mm.



### METAL FINNERA

for metal roof covered with profiled  
metal sheets of the module FINNERA  
330/30 mm.



### METAL JANOSIK

for metal roof covered with profiled  
metal sheets of the module JANOSIK  
380/35 mm.



### METAL GERMANIA

for metal roof covered with profiled  
metal sheets of the module GERMANIA  
SIMETRIC 350/30 mm



# STEP SET

Chimney step in a complete assembly set consisting of two **SUPPORT** adapters and one chimney **STEP**. The elements made of galvanized steel form a complete system for safe traffic on the roof slope of an angle of 15° to 60°. The product features anti-slip corrugations and a hand grip.



RAL: 8004; 8017; 8019;  
9005; 7016; 8012; 3004



1 set (2 x STEP,  
2 x SUPPORT)



50 sets



**UNI**  
for flat roof coverings,  
e.g. bituminous shingle.



**METAL FLAT**  
for metal flat roofs coverings  
finished on a standing seam.



**DB-DC LONG**  
for large sized interlocking roof tiles  
requiring less than 10 pcs./sqm.



**DB-DC SHORT**  
for interlocking roof tiles requiring over  
10 pcs./sqm and beaver-tail roof tiles  
laid in double-lap pattern.



**METAL 350**  
for metal roof covered with profiled  
metal sheets of the module 350/20 mm.



**METAL 400**  
for metal roof covered with profiled  
metal sheets of the module 400/20 mm.



**METAL VENECJA**  
for metal roof covered with profiled  
metal sheets of the module VENECJA  
350/35 mm.



**METAL FINNERA**  
for metal roof covered with profiled  
metal sheets of the module FINNERA  
330/30 mm.



**METAL JANOSIK**  
for metal roof covered with profiled  
metal sheets of the module JANOSIK  
380/35 mm.



**METAL GERMANIA**  
for metal roof covered with profiled  
metal sheets of the module GERMANIA  
SIMETRIC 350/30 mm.

## › Eurovent® STEP SET DB-DC – Ceramic roof tile

- 1 Eurovent® STEP
- 2 Eurovent® SUPPORT DB-DC LONG
- 3 Eurovent® HOME PRO
- 4 Eurovent® PUR
- 5 Additional batten
- 6 Batten
- 7 Counter batten
- 8 Thermal insulation
- 9 Roof tile









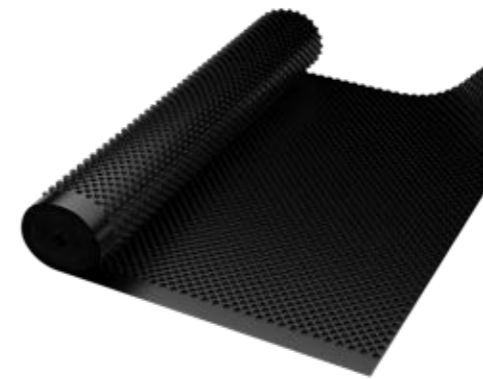



## GEO 8 ECO



- Studded foundation foil made of high-density polyethylene (HDPE) characterized by diagonal dimple pattern.
- Resistant to compression, ensures proper ventilation and protects against penetration of ground water and moisture, forms a layer of thermal and acoustic insulation.
- Resistant to acids, alkalis, solvents, bacteria, fungi as well as damage caused by plant roots.

						
ca. 400 g/m <sup>2</sup> ca. 500 g/m <sup>2</sup> ca. 600 g/m <sup>2</sup> ca. 800 g/m <sup>2</sup> ca. 1000 g/m <sup>2</sup>	ca. 200 kN/m <sup>2</sup>	0,5 m; 1,0 m; 1,5m; 2,0 m; 2,5 m; 3,0 m*; 4,0 m* x 20 rm	8 mm	1860/m <sup>2</sup>	ca. -40 °C do +80 °C	0,5 m - 60 rolls 1,0 m - 30 rolls other - 15 rolls

### Application

- For vertical insulation of foundation walls and ceilings. It protects them against mechanical damage as well as against damage caused by wooden roots and shrubs
- Constitutes ideal drainage and ventilation forms for vertical walls.
- Used also in case of terraces and balconies.
- Balances hydrostatic pressure.

- 1 Eurovent® GEO 8 ECO
- 2 Foundation insulation - XPS
- 3 Anti-moisture insulation
- 4 Foundation
- 5 Eurovent® MAUER PVC
- 6 Foundation platform
- 7 Ground
- 8 Drainage pipe
- 9 Eurovent® GEO TEX
- 10 Sand gravel
- 11 Eurovent® GEO LINE

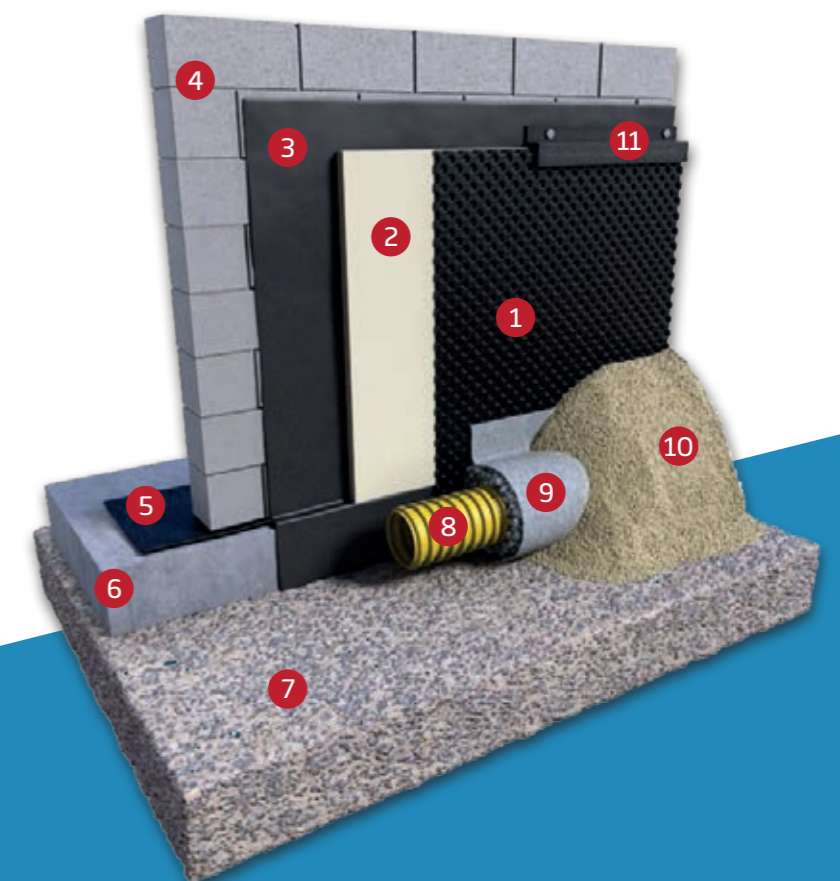

## › Foundation foils





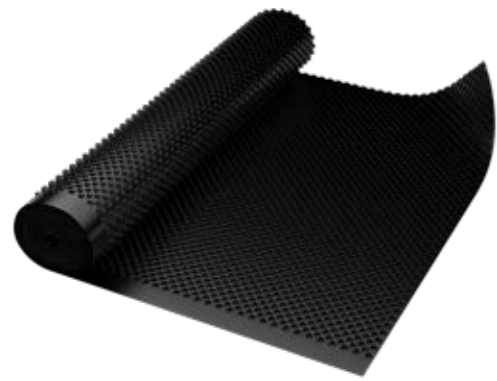

Extruded insulating foils for damp-proof vertical insulation and the horizontal one in case of foundations, residential and industrial buildings.





## GEO 8 S

- Studded foundation foil made of high-density polyethylene (HDPE) characterized by diagonal dimple pattern.
- Resistant to compression, ensures proper ventilation and protects against penetration of ground water and moisture, forms a layer of thermal and acoustic insulation
- Resistant to acids, alkalid, solvents, bacteria, fungi as well as damage caused by plant roots.

						
ca. 400 g/m <sup>2</sup>	ca. 200 kN/m <sup>2</sup>	0,5 m; 1,0 m; 1,5 m; 2,0 m x 20 rm	8 mm	2115 m <sup>2</sup>	ca. -30 °C to +80 °C	0,5 m - 48 rolls 1,0 m - 24 rolls other - 12 rolls

### Application







- For insulation of foundation walls and ceilings. It protects them against mechanical damage as well as against wooden roots and shrubs harmful activity.
- Is an ideal drainage and a ventilation for vertical walls.
- Used also in case of terraces and balconies.
- Balances hydrostatic pressure.

- 1 Eurovent® GEO 8 S
- 2 Foundation insulation - XPS
- 3 Anti-moisture insulation
- 4 Foundation
- 5 Eurovent® MAUER PVC
- 6 Foundation platform
- 7 Ground
- 8 Drainage pipe
- 9 Eurovent® GEO TEX
- 10 Sand gravel
- 11 Eurovent® GEO LINE



## GEO 8 TEX

- Drainage foundation foil made of high-density polyethylene (HDPE) with a parallel dimple pattern connected with geotextile.
- Resistant to compression and moisture.
- Forms a ventilation layer, thermal and acoustic insulation, ensures double drainage on the filter basis.

					
ca. 300 kN/m <sup>2</sup>	2,0 m x 20 rm	8 mm	1710/m <sup>2</sup>	ca. -40 °C to +80 °C	6 rolls

### Application

- For vertical insulation in foundation walls, recommended for application in historic sites where it ensures proper drainage and mechanical protection, forms two venting slots providing additional ventilation of the insulated surface.
- Excellent solution in areas with high levels of ground water, irreplaceable by conducting circumferential drainage.
- Used for insulation of retaining walls where it protects against water, root damage as well as corrosion.
- Used as horizontal insulation in roof gardens and to protect insulation boards in reverse roof technology where its ventilation and drainage capacity is irreplaceable.

- 1 Eurovent® GEO 8 TEX
- 2 Ground insulation - XPS
- 3 Anti-moisture insulation
- 4 Base Ground
- 5 Gravel
- 6 Ground
- 7 Grass
- 8 Paving

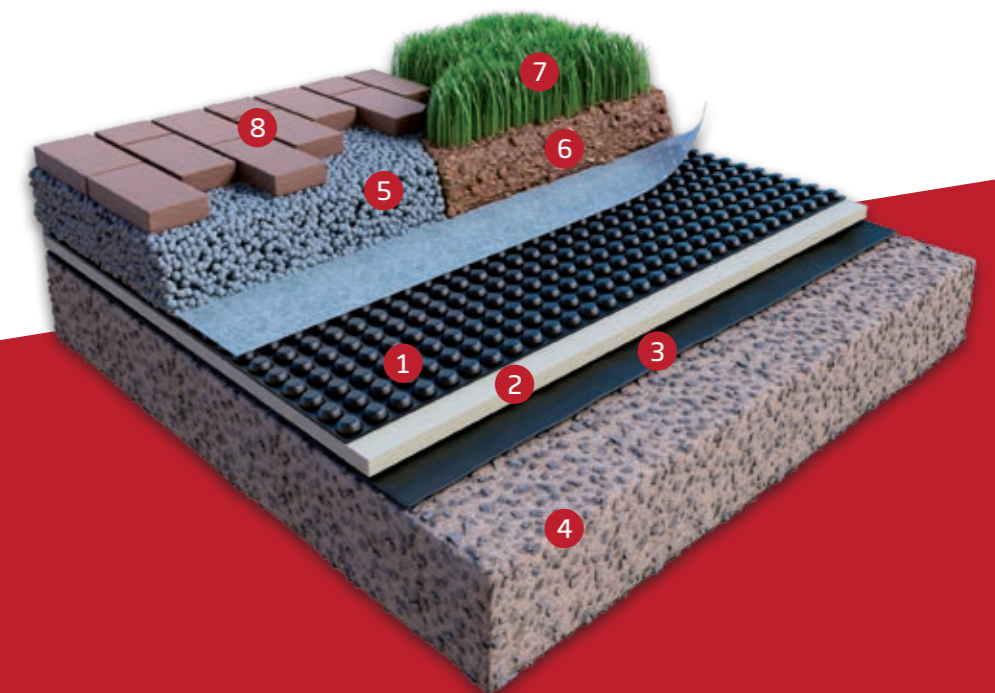



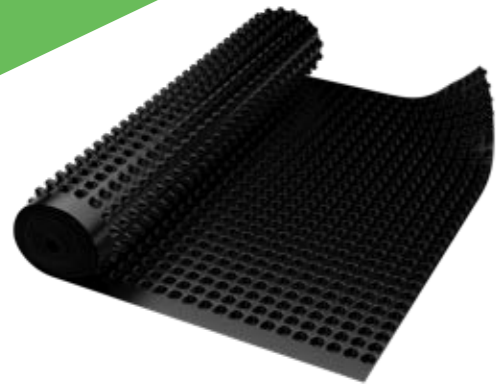

## GEO 20 ECO

- Drainage foundation foil made of high-density polyethylene (HDPE) with a parallel dimple pattern 20 mm high.
- Resistant to compression, acids, alkali, solvents, bacteria, fungi as well as damage caused by plant roots. Is equipped with an increased drainage capacity, forms a layer of thermal and acoustic insulation.

ca. 180 kN/m <sup>2</sup>	1,90 m x 20 rm	20 mm	ca. -30 °C to +80 °C	5 rolls

### Application

- Designed for use as vertical and horizontal hydro-insulation of buildings.
- Recommended for application in case of big in-depth engineering, e.g. in underground parking lots and tunnels, as well as other similar investments which require reliable protection and drainage.
- Used as insulation where deep foundations are exposed to the risk of temporary fluctuations of subsurface water levels. In such cases, it is laid with a slope between the foundation slab and the screed or concrete screed.
- The foil proves an excellent solution for securing constructions where there is not enough room to establish the formwork – it is suitable for installation between the shotcrete and the final concrete wall.

- 1 Eurovent® GEO 20 ECO
- 2 Separation layer
- 3 Drainage pipe
- 4 Reinforcement
- 5 Concrete
- 6 Ground

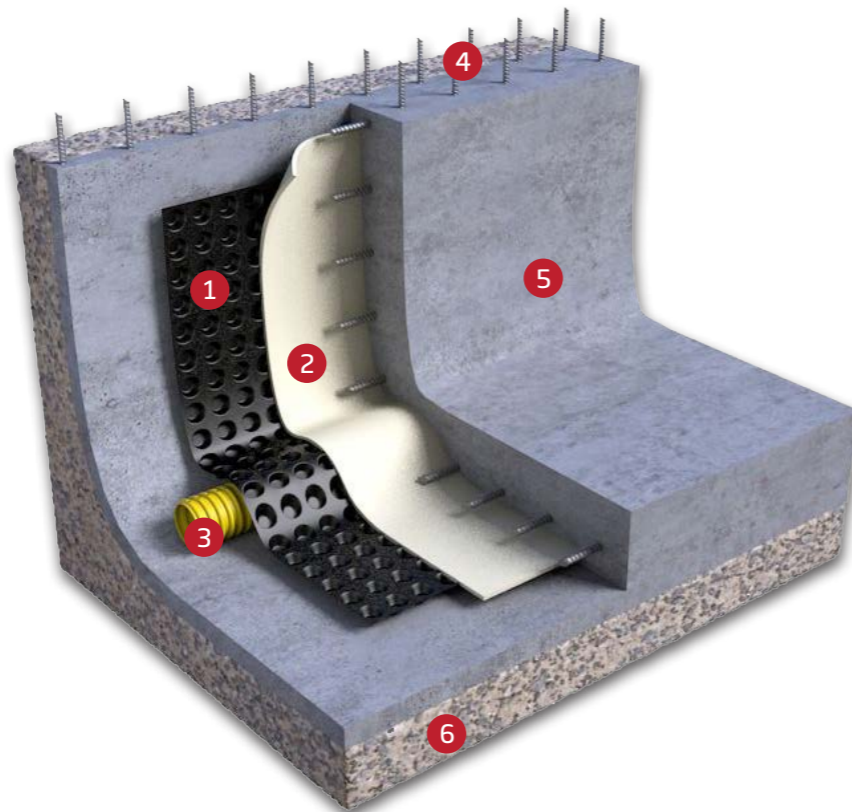

## GEO 20 GARDEN

- Drainage-cumulative foundation foil made of high-density polyethylene (HDPE) with a parallel dimple pattern 20 mm high with an additional perforation.
- Resistant to compression, acids, alkali, solvents, bacteria, fungi as well as damage caused by plant roots.
- High dimples and perforation provide additional water storage capacity as well as drainage of its excess.
- Moreover, it forms a layer of thermal and acoustic insulation.

ca. 180 kN/m <sup>2</sup>	2,0 m x 20 rm	20 mm	ca. -30 °C to +80 °C	5 rolls

### Application

- The foil is designed mainly for use as hydro-insulation of buildings while constructing "garden roofs".
- When applied as horizontal insulation, the foil is placed on the insulated surface with dimples upwards, then forms a draining surface which ensures continuous excessive water withdrawal in the periods of heavy downfalls. At the same time large dimples ensure retention of water supply necessary for plants.

- 1 Eurovent® GEO 20 GARDEN
- 2 Eurovent® GEO TEX
- 3 Ground
- 4 Grass
- 5 XPS insulation
- 6 Base ground

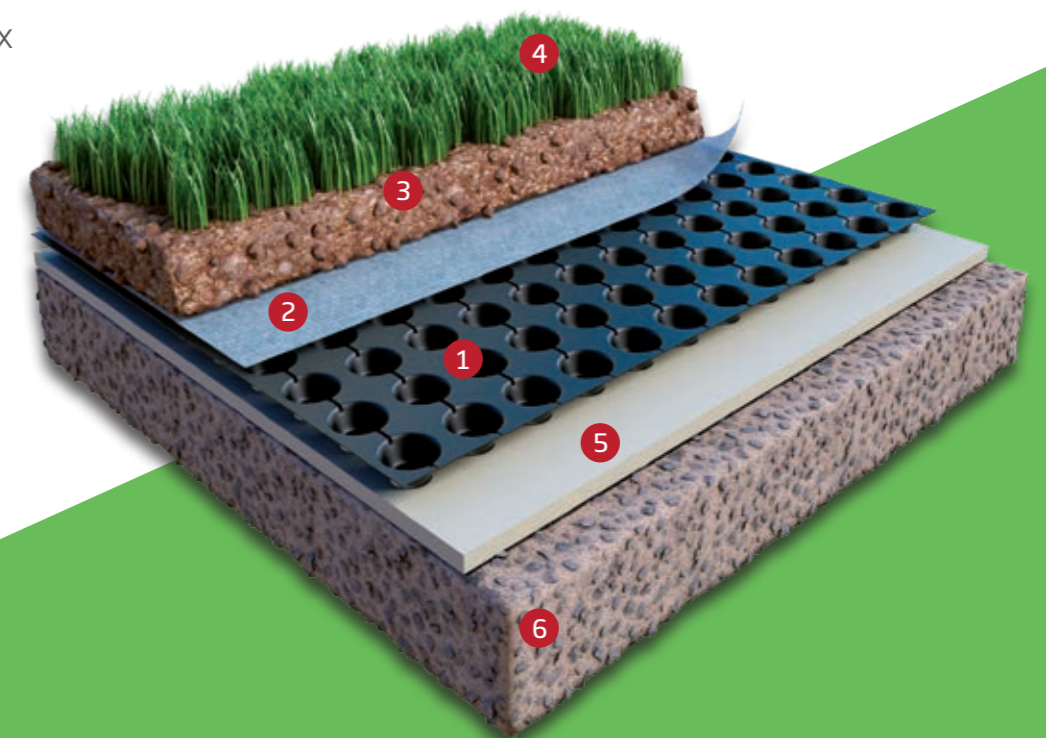



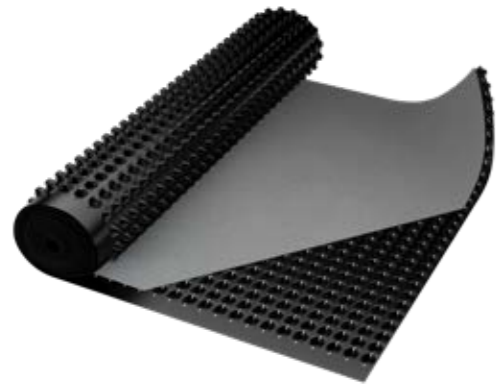







## GEO GARDEN DUO

- Drainage-cumulative foundation foil made of high-density polyethylene (HDPE) with a parallel dimple pattern 20 mm high with an additional perforation.
- Integrated with the filter fabric (PP), the dimples store water and the excess water is drained off.

					
HDPE: 1 kg/m <sup>2</sup> PP: 100 g/m <sup>2</sup>	ca. 180 kN/m <sup>2</sup>	1,90 m x 10 rm	20 mm	ca. -30 °C to +80 °C	5 rolls

### Application



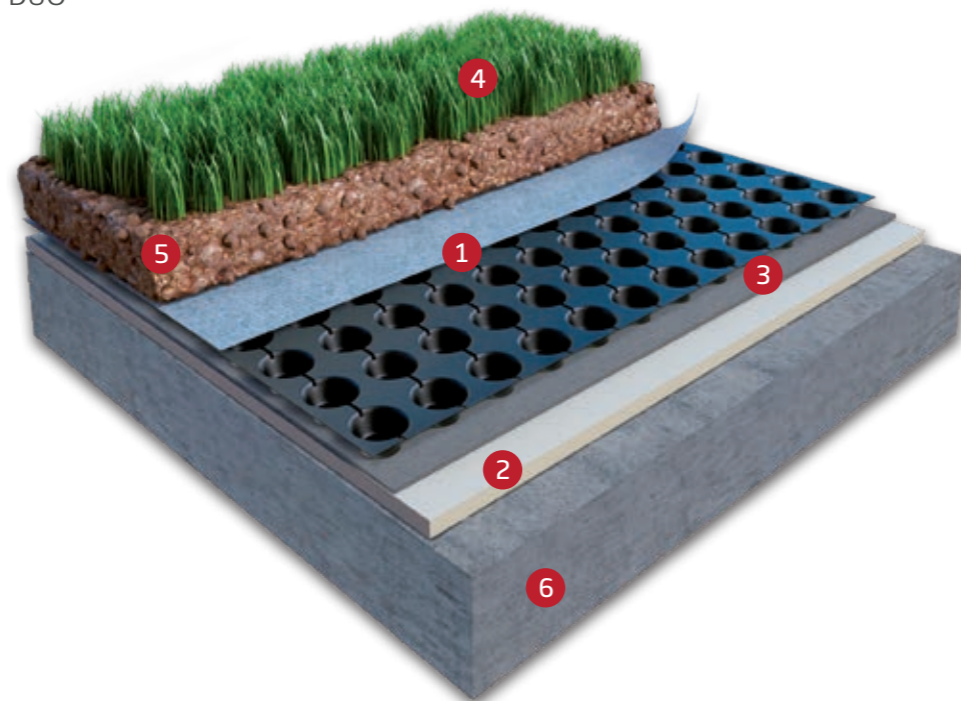

- The foil is designed mainly for use as horizontal hydro-insulation of buildings while constructing "garden roofs".
- It forms a drainage surface that drains off excess water during periods of heavy rainfall. At the same time, high dimples serve as water retentions supplying plants with the necessary amount of water.
- The integrated non-woven fabric ensures filtration and prevents the extrusions from being filled with earth substrate.

- 1 Eurovent® GEO GARDEN DUO
- 2 Hydro-insulation
- 3 Mat diffusion
- 4 Grass
- 5 Ground
- 6 Concrete ceiling



## MAUER PVC

- High-quality horizontal insulation foil for foundations made of PVC with a special delicate system of dimples to provide anti-slip properties and ensure that product perfectly bonds with mortar.
- Ideal flexibility allows for excellent adhesion and resistance to substrate deformations while stable strength parameters guarantee that the product's insulation remains tight.
- Resistant to aging, decay and moisture.

				
ca. 1,60 kg/m <sup>2</sup>	0,25 m; 0,30 m; 0,40 m; 0,50 m; 0,60 m; 1,0 m x 30 rm	ca. 1 mm	ca. -30 °C to +80 °C	0,25 m - 80 rolls 0,30; 0,40 m - 60 rolls 0,50; 0,60 m - 40 rolls 1,0 m - 20 rolls

### Application

- The horizontal insulation for foundations MAUER PVC is designed for use as waterproofing insulation to protect buildings with and without basements against capillary moisture.
- It is designed to create thick and durable hydro-insulation of buildings as horizontal insulation of foundation benches for load-bearing walls of buildings, for brickwork and partition walls as an alternative to roofing felt.
- Joined by the adhesion method as well as by the use of tape.

- 1 Eurovent® MAUER PVC
- 2 Foundation Wall
- 3 Foundation bench
- 4 Ground







## GEO MATT

- Single-layer mat made of extruded single polypropylene fibres stabilized against UV radiation.
- The multifunctional mat is suitable for use on metal roofs, metal facades and geotechnics.
- Due to its spatial structure, it is successfully used as a separating, drainage, strengthening and stabilizing element.

ca. 300 g/m <sup>2</sup>	1,4 m x 25 rm	ca. 8 mm	ca. -30 °C to +80 °C	9 rolls

### Application

- It is used in road engineering as an element strengthening and stabilising the ground surface, strengthening slopes, draining drainage ditches.
- It is used in geotechnics thanks to the ability of filling about 80-90% of its space, it is ideally suited as an element strengthening and stabilizing the ground surface.

- 1 Eurovent® GEO MATT
- 2 Humus
- 3 Grass
- 4 Ground

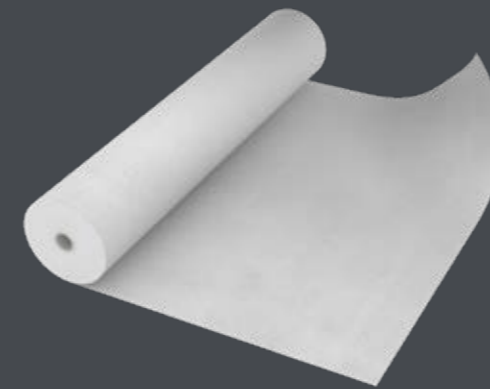
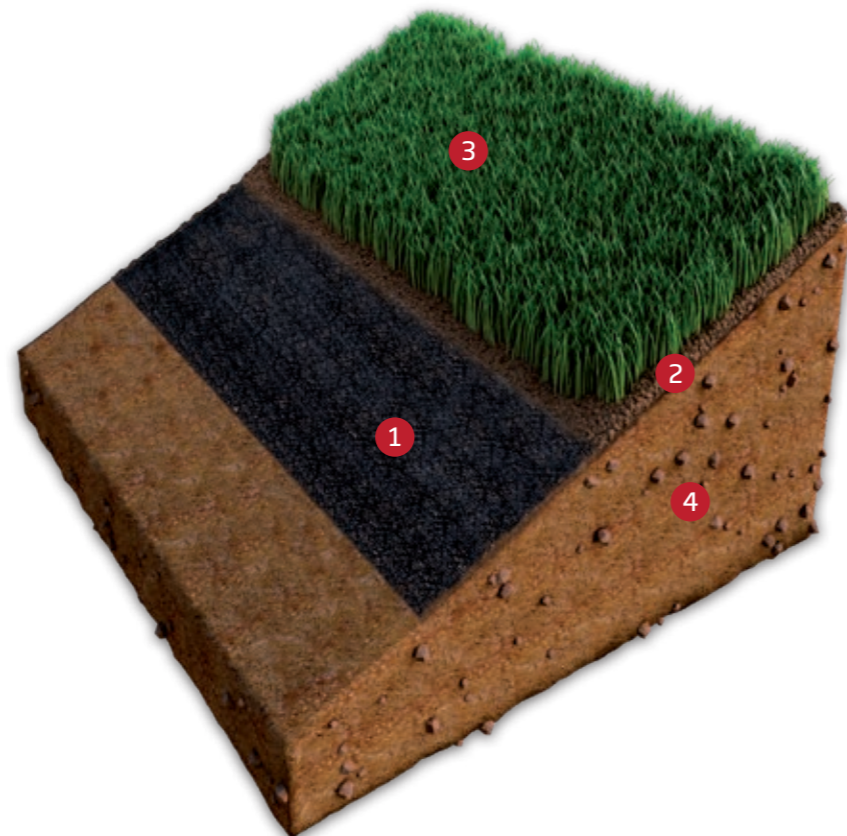

## GEO TEX

- The geotextile is made of thermosetting polypropylene continuous fibres, stabilized against UV rays.
- The unique technology of its production ensures filter function, stabilizes soil, separates ground layers.
- Protects other materials against damage.

ca. 100 g/m <sup>2</sup>	ca. 0,07 m/s	0,5 m; 1,0 m; 1,5 m; 2,0 m x 50 rm	0,5 m – 96 rolls 1,0 m – 48 rolls other – 24 rolls

### Application

- The geotextile GEO TEX is designed for use in construction of parking lots, sport fields, pavements and bike paths, as well as for vertical drainage, water and with a drainage pipe.
- When used as filtration layer, the product ensures long-term filtering performance useful especially for planting greenery on river banks and by water reservoirs.
- Enhances watering plants by roads and streets as well as preventing the wash-out of sand during paving works.

- 1 Eurovent® GEO TEX
- 2 Gravel
- 3 Sand
- 4 Paving
- 5 Ground

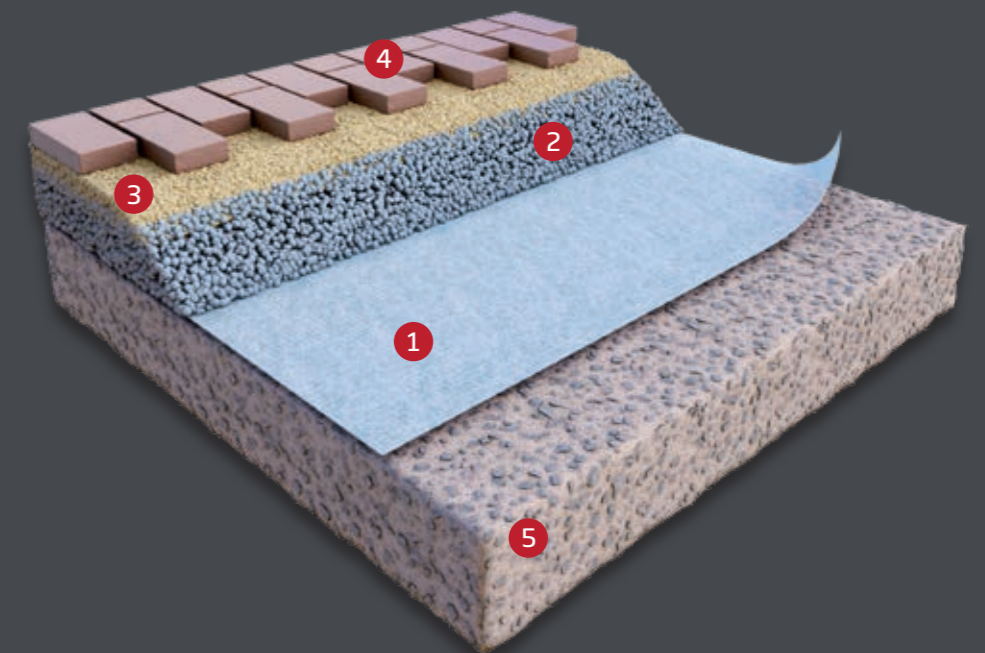





## › Accessories

Finishing strips and other accessories necessary for proper installation as well as for sealing foundation foils.

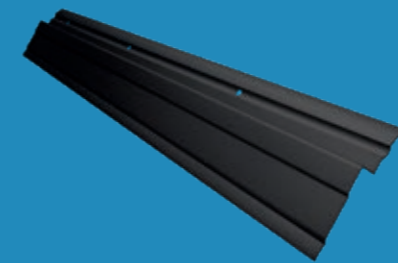

### GEO LINE

- Special finishing profile designed for installation of foundation foils. The shape of the profile ensures perfect adherence of the foundation foil upper edge to the insulated surface.
- Manufactured from a special plastic, extremely resistant to aging.



2 m



25 pcs.



3 750 pcs.



### GEO NAIL

- Special fastening nails made of tempered steel and designed for installation of foundation foils with 8 mm dimples.
- They are equipped with a special plastic pad which ensures tight sealing of nail punctures.



40 mm



100 pcs.



125 000 pcs.

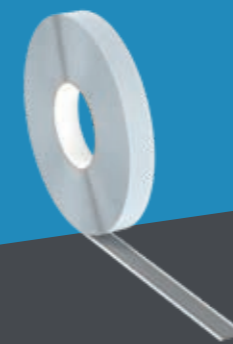

### GEO BUTYL

- Double-sided, solvent-free tape based on butyl with a separating silicone paper.
- Used for joining and sealing vapour-barrier foils, roof foils, foundation foils and other construction products.



15 mm x 25 m



>5°C



16 rolls



480 rolls

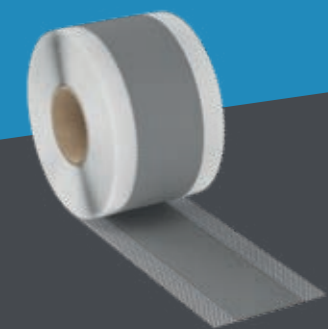

### GEO BAND

- Flexible sealing made of plastic (TPE) and polyester fabric.
- The product is designed for sealing settlement joints and welds in walls and floors of all types of buildings.



120 mm x 50 m



1 roll



120 rolls



# GADGETS

## Identify with Eurovent®

With our clients in mind, we have prepared a special set of gadgets which you will undoubtedly recognize by their unique design and high quality of production. Get them and become more familiar with us!



EUROVENT T-SHIRT



EUROVENT CAP



EUROVENT BAG



EUROVENT ROOFER BELT



EUROVENT ROOF METER



EUROVENT NOTEBOOK



EUROVENT BANNER  
 • Personalization possibilities  
 • Available in several formats



EUROVENT MAST FLAG  
 • Size 120 x 400 cm

EUROVENT WINDER  
 • Available sizes 60 x 200 cm;  
 100 x 300; 80 x 250





# POS COMMUNICATION

The Eurovent® expositors and stands line.

We put great attention at every single detail, the POS stands line enables exposition of advertising materials as well as the Eurovent® products in an organized, clear and aesthetic way.



## FREE-FLOATING DISPLAY

- 6 membrane applications are included in the set
- Interchangeable graphics
- LED backlight
- Set consisting of 11 grips for tapes
- Sizes 282 x 238 x 56 cm



## TAPE STAND

- 11 grips for tapes
- Basket for tubes and extra accessories
- Interchangeable graphics
- Sizes 54 x 186 x 50 cm



## MEMBRANE STAND

- Safety basket
- Interchangeable graphics
- Sizes 54 x 186 x 50 cm



## STANDY APPLICATION

- 10 samples of membranes and foils applications
- LCD screen with the Eurovent® movie
- Interchangeable graphics
- Sizes 83 x 210 x 51 cm



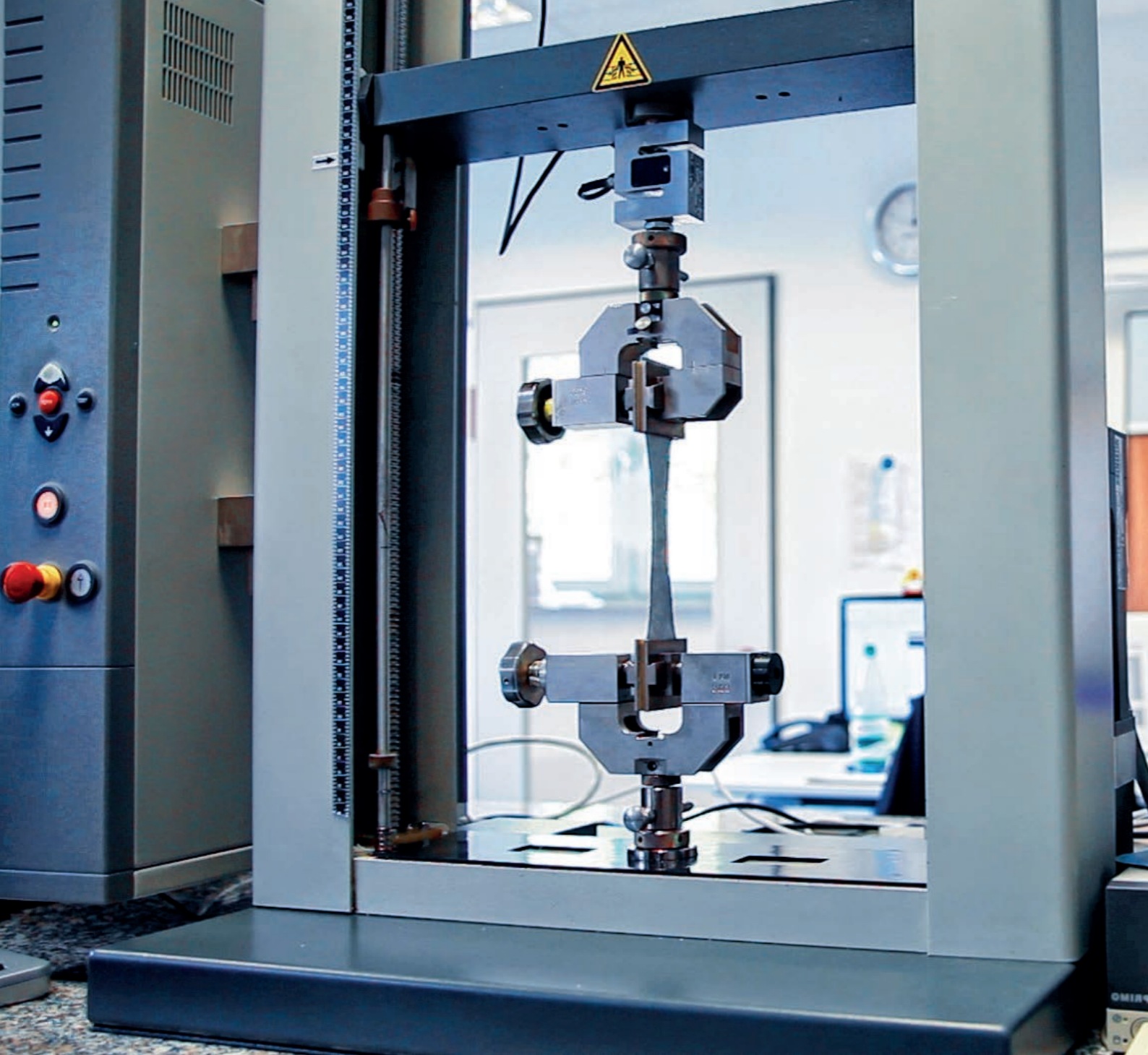

## › Technical data

Detailed comparison of technical and logistic data.

### ROOF MEMBRANES

PRODUCT	BASIC	CLASSIC	HOME PRO	MAXI
Page	15	15	16	16
Vapour-permeability	ca. 3000 g/m <sup>2</sup> /24h	ca. 3000 g/m <sup>2</sup> /24h	ca. 3000 g/m <sup>2</sup> /24h	ca. 3000 g/m <sup>2</sup> /24h
Reaction to fire	E	E	E	E
Temperature resistance	-40°C to +100°C	-40°C to +100°C	-40°C to +100°C / 120°C*	-40°C to +100°C / 120°C*
Sd value	ca. 0,02 m	ca. 0,02 m	ca. 0,02 m	ca. 0,02 m
UV resistance	4 months**	4 months**	4 months**	4 months**
Mass per unit	ca. 100 g/m <sup>2</sup>	ca. 120 g/m <sup>2</sup>	ca. 135 g/m <sup>2</sup>	ca. 140 g/m <sup>2</sup>
Water-tightness	W1	W1	W1	W1
Tensile strength MD/CD	≥ 210/130 N/50mm	≥ 250/180 N/50mm	≥ 270/210 N/50mm	≥ 270/210 N/50mm
Tear resistance MD/CD	≥ 70/70 N	≥ 120/120 N	≥ 150/160 N	≥ 160/150 N
Roll size	1,5 m x 50 rm = 75 m <sup>2</sup>	1,5 m x 50 rm = 75 m <sup>2</sup>	1,5 m x 50 rm = 75 m <sup>2</sup> 3,0 x 50 rm = 150 m <sup>2</sup> ***	1,5 m x 50 rm = 75 m <sup>2</sup>
Pallet	50 rolls	50 rolls	50 rolls	50 rolls

PRODUCT	MAXI PLUS	STRONG	SUPER	RFLEX
Page	17	17	20	20
Vapour-permeability	ca. 3000 g/m <sup>2</sup> /24h	ca. 3000 g/m <sup>2</sup> /24h	ca. 3000 g/m <sup>2</sup> /24h	ca. 3000 g/m <sup>2</sup> /24h
Reaction to fire	E	E	E	E
Temperature resistance	-40°C to +100°C / 120°C*	-40°C to +100°C / 120°C*	-40°C to +100°C / 120°C*	-40°C to +100°C / 120°C*
Sd value	ca. 0,02 m	ca. 0,02 m	ca. 0,02 m	ca. 0,02 m
UV resistance	4 months**	4 months**	4 months**	4 months**
Mass per unit	ca. 150 g/m <sup>2</sup>	ca. 160 g/m <sup>2</sup>	ca. 170 g/m <sup>2</sup>	ca. 160 g/m <sup>2</sup>
Water-tightness	W1	W1	W1	W1
Tensile strength MD/CD	≥ 300/220 N/50mm	≥ 370/430 N/50mm	≥ 340/250 N/50mm	≥ 330/230 N/50mm
Tear resistance MD/CD	≥ 175/150 N	≥ 340/390 N/50mm	≥ 200/210 N	≥ 130/140 N
Roll size	1,5 m x 50 rm = 75 m <sup>2</sup>	1,5 m x 50 rm = 75 m <sup>2</sup>	1,5 m x 50 rm = 75 m <sup>2</sup>	1,5 m x 50 rm = 75 m <sup>2</sup>
Pallet	50 rolls	40 rolls	40 rolls	40 rolls

PRODUCT	VSTRONG	XSTRONG	SUPER SA	COMFORT
Page	20	20	22	25
Vapour-permeability	ca. 3000 g/m <sup>2</sup> /24h	ca. 2500 g/m <sup>2</sup> /24h	ca. 135 g/m <sup>2</sup> /24h; ca. 122 g/m <sup>2</sup> /24h	ca. 2700 g/m <sup>2</sup> /24h
Reaction to fire	E	E	E	E
Temperature resistance	-40°C to +100°C / 120°C*	-40°C to +100°C / 120°C*	-30°C to +100°C	-40°C to +100°C / 120°C*
Sd value	ca. 0,02 m	ca. 0,04 m	ca. 0,17 m; ca. 0,19 m	ca. 0,03 m
UV resistance	4 months**	4 months**	4 months**	4 months**
Mass per unit	ca. 200 g/m <sup>2</sup>	ca. 250 g/m <sup>2</sup>	ca. 230 g/m <sup>2</sup> ; ca. 270 g/m <sup>2</sup>	ca. 220 g/m <sup>2</sup>
Water-tightness	W1	W1	W1	W1
Peel adhesion	-	-	≥ 25 N/25 mm	-
Shear adhesion	-	-	ca. 250 g/625 mm <sup>2</sup>	-
Tensile strength MD/CD	≥ 550/450 N/50mm	≥ 850/600 N/50mm	≥ 340/250 N/50mm	≥ 350/300 N/50mm
Tear resistance MD/CD	≥ 450/430 N	≥ 500/450 N	≥ 200/210 N	≥ 280/350 N
Roll size	1,5 m x 50 rm = 75 m <sup>2</sup>	1,5 m x 30 rm = 45 m <sup>2</sup>	1,5 m x 30 rm = 45 m <sup>2</sup>	1,5 m x 50 rm = 75 m <sup>2</sup>
Pallet	40 rolls	40 rolls	40 rolls	40 rolls

\* limited time exposure \*\*\* on order

\*\* UV stabilization according to artificial ageing performed in the laboratory related to the conditions of average sun exposure for the climate in Central Europe.



## ROOF MEMBRANES

PRODUCT	STRATOS	MONO	MAGNUM	BITUMI
Page	25	25	25	26
Vapour-permeability	ca. 3000 g/m <sup>2</sup> /24h	ca. 2000 g/m <sup>2</sup> /24h	ca. 300 g/m <sup>2</sup> /24h	ca. 0,5 g/m <sup>2</sup> /24h
Reaction to fire	B-s1, d0	E	E	E
Temperature resistance	-40°C to +100°C / 120°C*	-40°C to +100°C / 120°C*	-40°C to +100°C / 120°C*	-40°C to +100°C
Sd value	ca. 0,02 m	< 0,3 m (260 g/m <sup>2</sup> ) < 0,5 m (335 g/m <sup>2</sup> )	ca. 0,15 m	ca. 50 m
UV resistance	12 months**	4 months***	12 months***	3 months***
Mass per unit	ca. 210 g/m <sup>2</sup>	ca. 260 g/m <sup>2</sup> ca. 335 g/m <sup>2</sup>	ca. 210 g/m <sup>2</sup>	ca. 450 g/m <sup>2</sup>
Water-tightness	W1	W1	W1	W1
Tensile strength MD/CD	≥ 270/220 N/50mm	≥ 480/280 N/50mm (260 g) ≥ 550/450 N/50mm (335 g)	≥ 300/400 N/50mm	≥ 400/350 N/50mm
Tear resistance MD/CD	≥ 120/120 N	≥ 180/230 N (260 g) ≥ 320/340 N (335 g)	≥ 170/200 N	≥ 150/150 N
Roll size	1,5 m x 50 rm = 75 m <sup>2</sup>	1,5 m x 50 rm = 75 m <sup>2</sup>	1,5 m x 50 rm = 75 m <sup>2</sup>	1,0 m x 30 rm = 30 m <sup>2</sup>
Pallet	40 rolls	25 rolls	40 rolls	24 rolls

PRODUCT	SYNTEX	METALLIC	MATT
Page	26	27	27
Vapour-permeability	ca. 0,5 g/m <sup>2</sup> /24h	ca. 3000 g/m <sup>2</sup> /24h	-
Reaction to fire	E	E	E
Temperature resistance	-40°C to +100°C	-40°C to +100°C / 120°C*	-40°C to +100°C
Sd value	> 40 m	ca. 0,02 m	-
UV resistance	≤ 3 months***	4 months***	> 60 % after 430 hours.***
Mass per unit	ca. 170 g/m <sup>2</sup>	ca. 450 g/m <sup>2</sup>	ca. 300 g/m <sup>2</sup>
Water-tightness	W1	W1	-
Thickness at 2 kPa (200 kg/m <sup>2</sup> )	-	-	≥ 7,5 mm
Sound reduction	-	ca. -25 db	ca. -25 db
Tensile strength MD/CD	≥ 700/650 N/50mm	≥ 270/180 N/50mm	≥ 0,8/0,30 kN/m
Tear resistance MD/CD	≥ 235/280 N	≥ 180/200 N	-
Strain at max strenght MD/CD	-	-	ca. 90/65 %
Roll size	1,1 m x 50 rm = 55 m <sup>2</sup>	1,5 m x 25 m = 37,5 m <sup>2</sup>	1,4 m x 25 m = 35 m <sup>2</sup>
Pallet	40 rolls	8 rolls	9 rolls

\* limited time exposure \*\* on order

## VAPOUR BARRIER MEMBRANES

PRODUCT	AKTIV	AKTIV 3	CLIMA	CLIMA X
Page	34	34	34	34
Vapour-permeability	ca. 5-6 g/m <sup>2</sup> /24h	ca. 5-6 g/m <sup>2</sup> /24h	ca. 2-3 g/m <sup>2</sup> /24h	ca. 1-2 g/m <sup>2</sup> /24h
Reaction to fire	E	E	E	E
Temperature resistance	-40°C to +80°C / 100°C*	-40°C to +80°C / 100°C*	-40°C to +80°C / 100°C*	-40°C to +80°C / 100°C*
Sd value	ca. 8 m	ca. 10 m	ca. 10 m	ca. 10 m
Sd variable	ca. 2-16 m	ca. 2-16 m	ca. 2-16 m	ca. 2-16 m
UV resistance	3 months***	4 months***	2 months***	2 months***
Mass per unit	ca. 90 g/m <sup>2</sup>	ca. 140; 160 g/m <sup>2</sup>	ca. 85 g/m <sup>2</sup>	ca. 115 g/m <sup>2</sup>
Water-tightness	W1	W1	W1	W1
Tensile strength MD/CD	≥ 180/130 N/50mm	≥ 230/160 N/50mm	≥ 160/120 N/50mm	≥ 300/250 N/50mm
Tear resistance MD/CD	≥ 130/130 N	≥ 120/120 N	≥ 100/100 N	≥ 280/300 N
Roll size	1,5 m x 50 rm = 75 m <sup>2</sup> 3,0 m x 50 rm** = 150 m <sup>2</sup>	1,5 m x 50 rm = 75 m <sup>2</sup>	1,5 m x 50 rm = 75 m <sup>2</sup> 3,0 m x 50 rm** = 150 m <sup>2</sup>	1,5 m x 50 rm = 75 m <sup>2</sup>
Pallet	50 rolls	50 rolls	50 rolls	50 rolls

PRODUCT	AKTIV FR	AKTIV ALU	AKTIV PRO
Page	36	36	44-45
Vapour-permeability	≥ 0,5 g/m <sup>2</sup> /24h	ca. 1-2 g/m <sup>2</sup> /24h	ca. 20000 MNs/g
Reaction to fire	B-s1, d0****	E	A1 (non cormustible)
Sound reduction	-	-	-13 dB (product alone)
Thermal resistance	-	-	1,55 m <sup>2</sup> .K/W
Thermal conductivity (λ)	-	-	0,028 W/mK
Temperature resistance	-40°C to +80°C / 100°C*	-40°C to +80°C / 100°C*	-
Sd value	ca. 150 m	ca. 40 m	ca. 4000 m
UV resistance	2 months***	2 months***	-
Emissivity	< 0,05 ε	-	5 %
Reflectivity	-	-	95 %
Mass per unit	ca. 150 g/m <sup>2</sup>	ca. 110 g/m <sup>2</sup>	ca. 830 g/m <sup>2</sup>
Water-tightness	W1	W1	W1
Thickness	-	-	6 mm
Tensile strength MD/CD	≥ 255/200 N/50mm	≥ 200/120 N/50mm	-
Tear resistance MD/CD	≥ 160/160 N	≥ 125/170 N	-
Roll size	1,5 m x 50 rm = 75 m <sup>2</sup> 3,0 m x 50 rm** = 150 m <sup>2</sup>	1,5 m x 50 rm = 75 m <sup>2</sup>	1,0 m x 25 rm = 25 m <sup>2</sup> 1,93 x 15 rm = 28,95 m <sup>2</sup>
Pallet	40 rolls	50 rolls	12 rolls

\*\*\* UV stabilization according to artificial ageing performed in the laboratory related to the conditions of average sun exposure for the climate in Central Europe.  
\*\*\*\* In order to maintain the highest flame retardance parameters, the product should be applied on the substrate - in accordance with the test report.



## WIND BARRIER MEMBRANES

PRODUCT	WALL PROTECT	WALL PROTECT 3	WALL PROTECT FR	HOME PRO
Page	48	48	49	49
Vapour-permeability	ca. 3000 g/m <sup>2</sup> /24h	ca. 3000 g/m <sup>2</sup> /24h	ca. 144 g/m <sup>2</sup> /24h	ca. 3000 g/m <sup>2</sup> /24h
Reaction to fire	E	E	B-s1, d0****	E
Temperature resistance	-40°C do +100°C	-40°C do +100°C	-40°C do +100°C	-40°C do +100°C / 120°C*
Sd value	ca. 0,02 m	ca. 0,02 m	ca. 0,14 - 0,18 m	ca. 0,02 m
UV resistance	4 months***	4 months***	4 months***	4 months***
Mass per unit	ca. 100 g/m <sup>2</sup>	ca. 90 g/m <sup>2</sup>	ca. 150 g/m <sup>2</sup>	ca. 135 g/m <sup>2</sup>
Windproof	< 0,06 (m <sup>3</sup> /m <sup>2</sup> /h/100Pa)	< 0,06 (m <sup>3</sup> /m <sup>2</sup> /h/100Pa)	< 0,06 (m <sup>3</sup> /m <sup>2</sup> /h/100Pa)	< 0,06 (m <sup>3</sup> /m <sup>2</sup> /h/100Pa)
Water-tightness	W3	W1	W2	W1
Tensile strength MD/CD	≥ 240/160 N/50mm	≥ 210/130 N/50mm	≥ 250/200 N/50mm	≥ 270/210 N/50mm
Tear resistance MD/CD	≥ 100/100 N	≥ 110/110 N	≥ 160/160 N	≥ 150/160 N
Roll size	1,5 m x 50 rm = 75 m <sup>2</sup> 3,0 m x 50 rm = 150 m <sup>2</sup>	1,5 m x 50 rm = 75 m <sup>2</sup> 3,0 m x 50 rm = 150 m <sup>2</sup>	1,5 m x 50 rm = 75 m <sup>2</sup> 3,0 m x 50 rm = 150 m <sup>2</sup>	1,5 m x 50 rm = 75 m <sup>2</sup>
Pallet	50 rolls	50 rolls	50 rolls	50 rolls

PRODUCT	FASSADE	FIBER PRO
Page	49	50-51
Vapour-permeability	ca. 3000 g/m <sup>2</sup> /24h	ca. 0,25 MNs/g
Temperature resistance	-40°C do +100°C / 120°C*	-
UV resistance	12 months***	-
Reaction to fire	B-s1, d0	A2-s1, d0
Sound reduction	-	-16 dB (Product alone)
Thermal resistance	-	1,7 m <sup>2</sup> .K/W
Thermal conductivity (λ)	-	0,029 W/mK
Sd value	ca. 0,02 m	ca. 0,05 m
Mass per unit	ca. 210 g/m <sup>2</sup>	ca. 1388 g/m <sup>2</sup>
Emissivity/ Reflectivity	-	5/95 %
Tensile strength MD/CD	≥ 300/200 N/50mm	≥ 630/630 N/50mm
Tear resistance MD/CD	≥ 120/120 N	≥ 275/280 N
Water-tightness	W1	W1
Windproof	< 0,06 (m <sup>3</sup> /m <sup>2</sup> /h/100Pa)	-
Thickness	-	8 mm
Roll size	1,5 m x 50 rm = 75 m <sup>2</sup>	1,12 m x 18 rm = 20,16 m <sup>2</sup>
Pallet	40 rolls	12 rolls

## INSULATING FOILS

PRODUCT	STANDARD	SPECIAL	SPECIAL FR <sub>5000</sub>	SILVER
Page	57	57	57	57
Vapour-permeability	ca. 40 g/m <sup>2</sup> /24h	ca. 40 g/m <sup>2</sup> /24h	ca. 40 g/m <sup>2</sup> /24h	ca. 40 g/m <sup>2</sup> /24h
Reaction to fire	F	F	B-s1, d0	F
Temperature resistance	-40°C to +80°C	-40°C to +80°C	-40°C to +80°C	-40°C to +80°C
Sd value	ca. 1 m	ca. 1 m	ca. 1 m	ca. 1 m
UV resistance	2 months***	2 months***	2 months***	2 months***
Mass per unit	ca. 90 g/m <sup>2</sup>	ca. 110 g/m <sup>2</sup>	ca. 110 g/m <sup>2</sup>	ca. 90 g/m <sup>2</sup>
Water-tightness	W3	W2	W3	W2
Tensile strength MD/CD	≥ 260/140 N/50mm	≥ 260/140 N/50mm	≥ 200/130 N/50mm	≥ 410/390 N/50mm
Tear resistance MD/CD	≥ 100/110 N	≥ 100/110 N	≥ 100/110 N	≥ 460/470 N
Roll size	1,5 m x 50 rm = 75 m <sup>2</sup>	1,5 m x 50 rm = 75 m <sup>2</sup>	2,0 m x 50 rm = 100 m <sup>2</sup>	1,5 m x 50 rm = 75 m <sup>2</sup>
Pallet	120 rolls	120 rolls	120 rolls	120 rolls

PRODUCT	ANTICON	STANDARD N	SPECIAL N	SPECIAL N FR <sub>5000</sub>
Page	58	58	59	59
Vapour-permeability	ca. 1 g/m <sup>2</sup> /24h	ca. 1 g/m <sup>2</sup> /24h	ca. 1 g/m <sup>2</sup> /24h	≥ 6,34.10-15 g/m <sup>2</sup> .s-Pa (110 g/m <sup>2</sup> ) ≥ 4,54.10-15 g/m <sup>2</sup> .s-Pa (140 g/m <sup>2</sup> )
Reaction to fire	F	F	F	B-s1, d0
Temperature resistance	-40°C to +80°C	-40°C to +80°C	-40°C to +80°C	-40°C to +80°C / 100°C*
Sd value	ca. 40 m	≥ ca. 40 m	≥ ca. 40 m	ca. 50 m (110 g/m <sup>2</sup> ) ca. 110 m (140 g/m <sup>2</sup> )
UV resistance	2 months***	2 months***	2 months***	2 months***
Mass per unit	ca. 110; ca. 130 g/m <sup>2</sup>	ca. 90 g/m <sup>2</sup>	ca. 110 g/m <sup>2</sup>	ca. 110 g/m <sup>2</sup> ; ca. 140 g/m <sup>2</sup>
Water-tightness	W1	Waterproof at 2 Kpa	W1	W1
Tensile strength MD/CD	≥ 410/390 N/50mm	≥ 260/140 N/50mm	≥ 260/140 N/50mm	≥ 200/130 N/50mm (110 g/m <sup>2</sup> ) ≥ 200/135 N/50mm (140 g/m <sup>2</sup> )
Tear resistance MD/CD	≥ 460/470 N	≥ 100/110 N	≥ 100/110 N	≥ 110/110 N (110 g/m <sup>2</sup> ) ≥ 100/100 N (140 g/m <sup>2</sup> )
Roll size	1,5 m x 50 rm = 75 m <sup>2</sup>	1,5 m x 50 rm = 75 m <sup>2</sup>	1,5 m x 50 rm = 75 m <sup>2</sup>	2,0 m x 50 rm = 100 m <sup>2</sup> 1,5 m x 50 mb = 75 m <sup>2</sup> **
Pallet	120 rolls	120 rolls	120 rolls	110 g/m <sup>2</sup> : 120 rolls 140 g/m <sup>2</sup> : 100 rolls



## INSULATING FOILS

PRODUCT	SILVER N	STANDARD ALU	DB	BAU
Page	62	62	63	63
Vapour-permeability	ca. 1 g/m <sup>2</sup> /24h	ca. 0,1 g/m <sup>2</sup> /24h	-	-
Reaction to fire	F	F; B-s1, d0**	F	F
Temperature resistance	-40°C to +80°C	-40°C to +80°C	-40°C to +80°C	-40°C to +80°C
Sd value	ca.40 m	ca.150 m	ca. 50 m	ca. 50 m
UV resistance	2 months***	2 months***	2 months***	2 months***
Mass per unit	ca. 90 g/m <sup>2</sup>	ca. 90; ca. 110; ca. 130; ca. 150; ca. 180 g/m <sup>2</sup>	-	-
Water-tightness	W1	W1	Waterproof at 2 Kpa	Waterproof at 2 Kpa
Tensile strength MD/CD	≥ 410/390 N/50mm	≥ 180/90 N/50mm	min. 150/min. 150 %	min. 150/min. 150 %
Tear resistance MD/CD	≥ 460/470 N	≥ 70/65 N	≥ 40/40 N	≥ 40/40 N
Roll size	1,5 m x 50 rm = 75 m <sup>2</sup>	1,5 m x 50 rm = 75 m <sup>2</sup>	2 m x 50 m = 100 m <sup>2</sup>	4 x 25; 5 m x 20 m = 100 m <sup>2</sup>
Pallet	120 rolls	150; 180 g/m <sup>2</sup> : 60 rolls other: 120 rolls	80 rolls	80 rolls

PRODUCT	ALUFLOOR
Page	64
Vapour-permeability	ca. 0,6 g/m <sup>2</sup> /24h
Reaction to fire	F
Temperature resistance	-40°C to +80°C
Sd value	ca. 70 m
UV resistance	2 months***
Mass per unit	ca. 110 g/m <sup>2</sup>
Water-tightness	Waterproof at 2 Kpa
Roll size	1,0 m x 50 m = 50 m <sup>2</sup>
Pallet	120 rolls

## RIDGE

PRODUCT	ROLL STANDARD	ROLL GEO	ROLL SUPER	ROLL ECCO
Page	69	69	69	69
Roll size	240 mm; 310 mm; 390 mm x 5 rm	180 mm; 240 mm; 310 mm; 390 mm x 5 rm	240 mm**; 310 mm; 390 mm x 5 rm	180 mm; 240 mm; 310 mm; 390 mm x 5 rm
RAL colour	8004; 8019; 9005; 7021; 8015; 3011; 8017; copper-CU**	8004; 8019; 9005; 7021; 8015; 3011; 8017; copper-CU**	8004; 8019; 9005; 7021; 8015; 3011; 8017; copper-CU**	8004; 8019; 9005; 7021; 8015; 3011; 8017
Box	4 rolls	4 rolls	4 rolls	4 rolls
Pallet	240mm: 168 rolls 310 mm: 144 rolls 390 mm: 100 rolls	180 mm: 192 rolls 240mm: 168 rolls 310 mm: 144 rolls 390 mm: 100 rolls	240mm: 168 rolls 310 mm: 144 rolls 390 mm: 100 rolls	180 mm: 192 rolls 240mm: 168 rolls 310 mm: 144 rolls 390 mm: 100 rolls

PRODUCT	ROLL TEC	ROLL METAL	ROLL METAL NEW
Page	70	70	70
Roll size	310 mm; 390 mm x 5 rm	300 mm; 400 mm x 5 rm	300 mm; 400 mm x 5 rm
RAL colour	8004; 8019; 9005; 7021; 8017	8004; 8019; 9005; 7021; 8015; 3011; 8017; copper-CU**	8004; 8019; 9005; 7021; 8015; 3011; 8017; copper-CU**
Box	4 rolls	4 rolls	4 rolls
Pallet	310 mm: 144 rolls 390 mm: 100 rolls	300 mm: 144 rolls 400 mm: 100 rolls	300 mm: 144 rolls 400 mm: 100 rolls

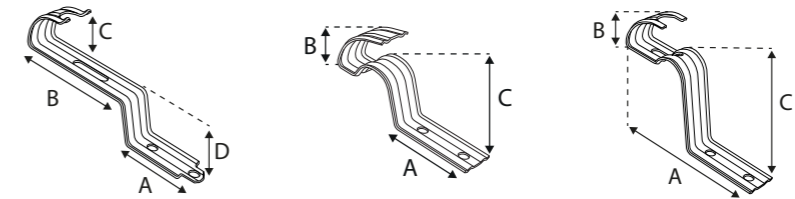

PRODUCT	GRIP UNI	GRIP CREATON	GRIP RÖBEN
Page	70	71	71
Model	470/53	470/24	470/163
Sizes	A: 48 mm B: 65 mm C: 23 mm D: 22 mm	A: 43 mm B: 28 mm C: 25 mm	A: 94 mm B: 20 mm C: 48 mm
RAL colour	8004; 8017; 3009; 7021	8004; 8017; 7021	8004; 8017; 7021; 9005
Box	50 pcs.	50 pcs.	50 pcs.
Pallet	10 000 pcs.	10 000 pcs.	10 000 pcs.

PRODUCT	CANTILEVER G	CANTILEVER B	CANTILEVER N	CANTILEVER L
Page	72	72	72	72
Width of cantilever	40 mm; 50 mm	40 mm; 50 mm	40 mm; 50 mm	40 mm; 50 mm
Height	180 mm; 210 mm; 230 mm; 260 mm; 310 mm**	210 mm	180 mm; 260 mm; 320 mm	205/225 mm
Box	100 pcs.	100 pcs.	100 pcs.	100 pcs.
Pallet	3 200 pcs.	3 200 pcs.	3 200 pcs.	3 200 pcs.

PRODUCT	AIR FLEX S	BITUVENT	DECK
Page	74	75	75
Sizes	75 mm x 1 m	290 mm x 1 m	165 mm x 220 mm
RAL colour	8004; 8019; 9005; 7021; 8015; 3013	9005	8004; 8019; 9005
Box	20 pcs.	10 pcs.	50 pcs.
Pallet	200 pcs.	100 pcs.	12 250 pcs.

\* limited time exposure \*\* on order

\*\*\* UV stabilization according to artificial ageing performed in the laboratory related to the conditions of average sun exposure for the climate in Central Europe.



## CHIMNEY

PRODUCT	FLEX STANDARD	FLEX 3D	FLEX 4D	FLEX STANDARD PB
Page	79	79	79	79
Roll size	300 mm x 5 rm	300 mm x 5 rm	300 mm x 5 rm	300 mm x 5 rm
RAL colour	8004; 8019; 9005; 7021; 8015; 3011; 8017; copper-CU**	8004; 8019; 9005; 7021; 8015; 3011; 8017; copper-CU**	8004; 8019; 9005; 7021; 8015; 3011; 8017; copper-CU**	8004; 8019; 9005; 7021; 8017
Box	1 roll	1 roll	1 roll	1 roll
Pallet	144 rolls	144 rolls	144 rolls	72 rolls

PRODUCT	FLEX SUPER PB	FLEX FLAT PB	FLEX EPDM	FLEX EPDM Q
Page	81	81	82	82
Roll size	300 mm x 5 rm	300 mm x 5 rm	300 mm x 5 rm	300 mm x 5 rm
RAL colour	8004; 8017; 8019; 9005; 7021; 8015	8004; 8017; 8019; 9005; 7021; 8015	8004; 8017; 9005; 7024	8004; 8017; 9005; 7024
Box	1 roll	1 roll	1 roll	1 roll
Pallet	60 rolls	60 rolls	144 rolls	144 rolls

PRODUCT	FLEXBIT	FLEX LINE	FLEX CORNER
Page	82	82	84
Size	100 mm; 150 mm; 300 mm x 10 rm	80 mm x 2 rm	13,6 mm x 2,5 m
RAL colour	Aluminum; RAL: 8004; 8017; 3004; 6020; 7016	8004; 8019; 9005; 7021; 8017	8004; 9005; 8019
Box	100 mm: 3 rolls 150 mm: 2 rolls 300 mm: 1 roll	20 pcs.	10 pcs.
Pallet	100 mm: 288 rolls 150 mm: 192 rolls 300 mm: 96 rolls	2 000 pcs.	800 pcs.

## CLIPS

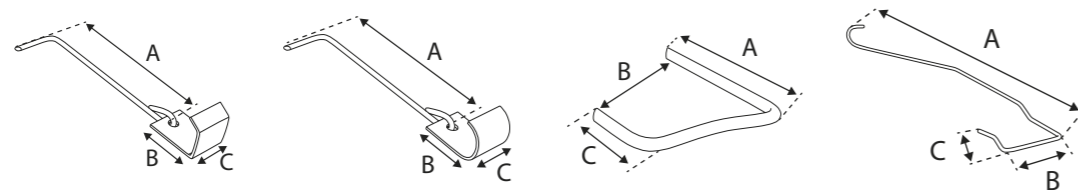

PRODUCT	CLIP NORD-2	CLIP NORD-3	CLIP U	CLIP J
Page	86	86	87	87
Type of roof tile	cement tile; ceramic tile	cement tile; ceramic tile	cement tile; ceramic tile	ceramic tile
Size	A: 65 mm B: 20 mm C: 15 mm	A: 65 mm B: 20 mm C: 15 mm	small: A: 45 mm B: 33 mm C: 25 mm big: A: 55 mm B: 40 mm C: 40 mm	A: 200 mm B: 50 mm C: 30 mm; A: 200 mm B: 40 mm C: 30 mm; A: 200 mm B: 30 mm C: 30 mm
Box	100 pcs.	100 pcs.	100 pcs.	100 pcs.
Pallet	96 000 pcs.	90 000 pcs.	96 000 pcs.	50 000 pcs.

## CLIPS

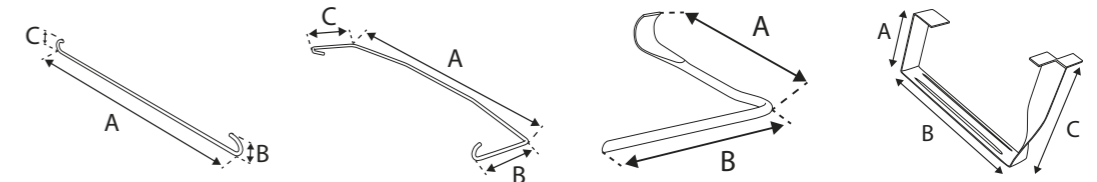

PRODUCT	CLIP J2	CLIP DC-6	CLIP DC-9	CLIP BIBER
Page	87	88	88	88
Type of roof tile	ceramic tile	ceramic tile	cement tile; ceramic tile	ceramic tile - beaver-tail tiles
Size	A: 320 mm B: 15 mm C: 15 mm	A: 200 mm B: 40 mm C: 40 mm	A: 65 mm B: 48 mm A: 75 mm B: 48 mm A: 85 mm B: 65 mm A: 75 mm B: 65 mm	A: 42 mm B: 90 mm C: 64 mm
Box	100 pcs.	100 pcs.	100 pcs.	100 pcs.
Pallet	12 000 pcs.	50 000 pcs.	32 000 pcs.	4 500 pcs.

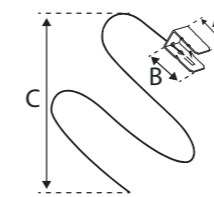

PRODUCT	CLIP C
Page	88
Type of roof tile	cut tiles
Size	A: 20 mm B: 30 mm C: 400 mm
Box	25 pcs.
Pallet	16 000 pcs.

## EAVES

PRODUCT	COMB X	COMB VENTI	GRATE VENTI	EAVES GRATE
Page	90	91	91	92
Size	60 mm; 80 mm; 100 mm x 1 rm	85 mm x 1 rm	32 mm x 1 rm	50 mm; 80 mm; 100 mm x 5 rm; BOX: 80 mm; 100 x 60 rm
RAL colour	8004; 8019; 9005	8004; 8019; 9005	8004; 8019; 9005	8004; 8019; 9005
Box	60 mm: 300 pcs. other: 50 pcs.	50 pcs.	100 pcs.	50 mm: 48 rolls other: 24 rolls BOX: 1 roll
Pallet	60 mm: 6 000 pcs. 80 mm: 4 000 pcs. 80 mm: 2 100 pcs.	1 000 pcs.	1 000 pcs.	50 mm: 1440 rolls 80; 100 mm: 840 rolls BOX: 54 rolls

PRODUCT	EAVES PLANK	EAVES GRATE ALU	EAVES GRATE RAL
Page	92	92	92
Size	45 mm x 110 mm x 2 rm 75 mm x 120 mm x 2 rm	BOX: 100 mm x 60 rm	BOX: 100 mm x 25 rm
RAL colour	8004; 8019; 9005; 7021; 8015; 3011; 8017	aluminum	7016/8017
Box	20 pcs.	1 roll	1 roll
Pallet	800 pcs.	54 rolls	80 rolls



## TAPES AND ADHESIVES

PRODUCT	BUTYL	BUTYL PRO	DUO	PUR
Page	94	94	95	95
Type of tape	Double-sided	Double-sided	Double-sided	Single-sided
Size	15 mm x 25 mb	45 mm x 20 mb	20 mm x 25 mb; 50 mm x 25 mb	40 mm x 25 mb
Application temperature	> 5°C	> 5°C	> 5°C	> 5°C
Box	16 rolls	8 rolls	20 mm: 14 rolls; 50 mm: 6 rolls	24 rolls
Pallet	480 rolls	240 rolls	20 mm: 1680 rolls; 50 mm: 720 rolls	288 rolls

PRODUCT	TOPBAND	UNO COLD UV	ALUFIX	HYDRAL
Page	96	96	97	97
Type of tape	Single-sided	Single-sided	Single-sided	Single-sided
Size	50 mm x 25 mb	50 mm x 25 mb	50 mm x 50 mb 75 mm x 50 mb	60 mm x 40 mb
Application temperature	> 5°C	- 10°C	> 5°C	> 5°C
UV resistance	-	< 24 months***	-	-
Box	12 rolls	12 rolls	50 mm: 36 rolls 80 mm: 24 rolls	10 rolls
Pallet	720 rolls	720 rolls	50 mm: 1296 rolls 80 mm: 864 rolls	600 rolls

PRODUCT	UNO	UNISAN	MULTI
Page	98	98	99
Type of tape	Single-sided	Single-sided	adhesive, acrylic emulsion
Capacity	-	-	310 ml
Size	50 mm x 25 mb	60 mm x 25 mb; 120 mm x 25 mb	-
Application temperature	> 5°C	> 5°C	-10°C up to +40°C
Box	12 rolls	10 rolls; 4 rolls	20 pcs.
Pallet	720 rolls	600 rolls 240 rolls	1 200 pcs.

PRODUCT	COMPRE X
Page	99
Type of tape	expanding
Size	15/30 mm x 6 mb 15/40 mm x 8 mb; 15/50 mm x 4,3 mb
Application temperature	> 5°C
Box	32 rolls 32 rolls 24 rolls

## WINDOW TAPES

PRODUCT	AKTIVBAND SK&SK2	DIFFUBAND SK&SK2	COMPRE 300	COMPRE 600
Page	103	104	106	106
Type of tape	Interior vapour-barrier window tape	exterior vapour-permeable window tape	expanding	expanding
Impermeable to driving rain	-	-	> 300 hPa	> 600 hPa
Size	70 mm x 25 mm 100 mm x 25 mm 150 mm x 25 mm	70 mm x 25 mm 100 mm x 25 mm 150 mm x 25 mm	Available on the page: 94	Available on the page: 94
Application temperature	> 0°C to +25°C	> 0°C to +25°C	> 5°C	> 5°C
Box	70 mm: 8 rolls; 100 mm: 6 rolls 150 mm: 1 roll	70 mm: 8 rolls; 100 mm: 6 rolls 150 mm: 1 roll	Available on the page: 94	Available on the page: 94
Pallet	70 mm: 384 rolls 100 mm: 288 rolls 150 mm: 240 rolls	70 mm: 384 rolls 100 mm: 288 rolls 150 mm: 240 rolls	-	-

PRODUCT	COMPRE 3W	EPDM PRO	CORNER PRO
Page	108	109	109
Type of tape	expanding - multi purpose	sealing	-
Thickness	-	EPDM - 0,75 mm; EPDM - 1,1 mm**	-
Impermeable to driving rain	> 600 hPa	-	-
Size	64/ 5-10 mm x 8 mm 74/ 5-10 mm x 8 mm 84/ 5-10 mm x 8 mm 64/ 10-20 mm x 6 mm 74/ 10-20 mm x 6 mm 84/ 10-20 mm x 6 mm	50 mm x 25 mm 60 mm x 25 mm 100 mm x 25 mm 110 mm x 25 mm 130 mm x 25 mm 150 mm x 25 mm 200 mm x 25 mm 250 mm x 25 mm 300 mm x 25 mm 400 mm x 25 mm 500 mm x 25 mm	100 mm x 120 mm 160 mm x 120 mm
Application temperature	- 30°C to + 80°C	- 30°C to + 80°C	> 5°C
Box	64/ - 7 rolls 74/ - 6 rolls 84/ - 5 rolls	60 mm: 5 rolls 50; 100; 150; 200 mm: 4 rolls other: 2 rolls	30 pcs.

## SEALING COLLAR

PRODUCT	SEAL	MINI SEAL	MULTI SEAL
Page	112	112	112
Type	pipes sealing collar	cable sealing collar	cable and pipe sealing collar
Model	R1; R2; R3; R4; R5; R6; R7; R8;	K1; K2	KM1; RM1
Diameter	R1: 15-22 mm R2: 25-33 mm R3: 40-55 mm R4: 50-72 mm R5: 72-90 mm R6: 100-110 mm R7: 100-125 mm R8: 125-135 mm	K1: 4-8 mm K2: 8-12 mm	KM1: 6 x 4-11 mm RM1: 6 x 16-25 mm
Size of base	R1: 150 x 150 mm R2: 150 x 150 mm R3: 230 x 230 mm R4: 230 x 230 mm R5: 230 x 230 mm R6: 320 x 320 mm R7: 350 x 350 mm R8: 320 x 320 mm	150 x 150 mm	KM1: 230 x 230 mm KM2: 320 x 320 mm
Box	R1-R3: 10 pcs. other: 4 pcs.	10 pcs.	4 pcs.

\*\* on order



## VALLEY

PRODUCT	VALLEY Q	VALLEY L	VALLEY CLIP	WEDGE
Page	115	115	115	116
Size	500 mm x 2 rm	500 mm x 2 rm	-	60 mm x 1 rm
RAL colour	8004; 8019; 9005; 7021; 8015; 3011; 8017	8004; 8019; 9005; 7021; 8015; 3011; 8017	8004; 8019; 9005; 8017	wall red; brown; anthracit
Box	10 sheets	10 sheets	50 pcs.	200 pcs.
Pallet	400 sheets	400 sheets	10 000 pcs.	2 000 pcs.

PRODUCT	SEAL 4
Page	116
Size	40 mm x 30 mm x 1 rm
RAL colour	wall red; brown; anthracit
Box	100 pcs.
Pallet	1 600 pcs.

## PROTECTION AND VENTILATION

PRODUCT	GUTTER PROTECT	ANTIBIRD UNO	ANTIBIRD DUO	VENTOS X
Page	119	119	119	120-123
Set	-	-	-	base plate; vent; screws
Size	175 mm x 600 mm	60 mm x 335 mm x 110 mm	90 mm x 340 mm x 110 mm	-
Diameter	-	-	-	150 mm
Model*	-	-	-	N25; G18; M11; R28; F22; W35; T18; T35; B26; BITU O; BITU UNI; C; R; S
RAL colour	9005	9006	9006	8004; 8019; 9005; 8017; 7024; 3009; 7021; 7036; 6020
Box	5 pcs.	15 pcs.	150 pcs.	1 Set
Pallet	3 200 pcs.	1800 pcs.	2 100 pcs.	36 Sets

PRODUCT	SATTOS X	VENTOS X FLAT	FLEXOS X	FLEX X
Page	123	123	126	126
Set	antenna adapter; cap; metal ring; screws	base plate; vent; screws	-	-
Size	-	-	600 mm	6 m
Diameter	-	150 mm	150/125/120/100/80 mm	150/150 mm
Model*	N25; G18; M11; R28; F22; W35; T18; T35; B26; BITU O; BITU UNI; C; R; S	N25; G18; M11; R28; F22; W35; T18; T35; B26; BITU O; BITU UNI; C; R; S	-	-
RAL colour	8004; 8019; 9005; 8017; 7024; 3009; 7021; 7036; 6020	8004; 8019; 9005; 8017; 7024; 3009; 7021; 7036; 6020	-	-
Box	1 Set	1 Set	12 pcs.	1 pcs.
Pallet	96 Sets	96 Sets	-	-

PRODUCT	CLIP X	RING X	SEAL EPDM
Page	126	126	127
Size	-	150/110 mm; 150/125 mm	75-160 mm
Diameter	150/150 mm	-	-
Size	1 pcs.	1 pcs.	1 pcs.

## SNOW PROTECTION

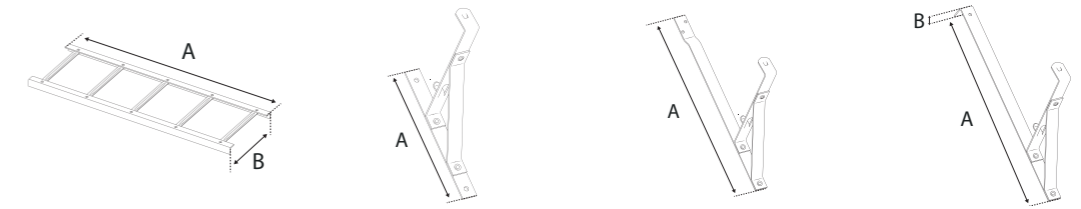

PRODUCT	SNOWSTOPPER	FIX UNI	FIX DB-DC	FIX BIBER
Page	137	137	137	139
Roof cover type	-	flat roof coverings	concrete roof tiles; ceramic roof tiles	ceramic roof tiles - beaver-tail tiles
Size	A: 1,0 m; 2,0 m; 3,0 m B: 200 mm	A: 270 mm	A: 540 mm	A: 580 mm B: 35 mm
RAL colour	Galvanized; RAL: 8004; 8017; 8019; 9005; 6020; 7016; 3009; 3004; 7024	Galvanized; RAL: 8004; 8017; 8019; 9005; 6020; 7016; 3009; 3004; 7024	Galvanized; RAL: 8004; 8017; 8019; 9005; 6020; 7016; 3009; 3004; 7024	Galvanized; RAL: 8004; 8017; 8019; 9005; 6020; 7016; 3009; 3004; 7024
Box	2 pcs.	5 pcs.	5 pcs.	5 pcs.

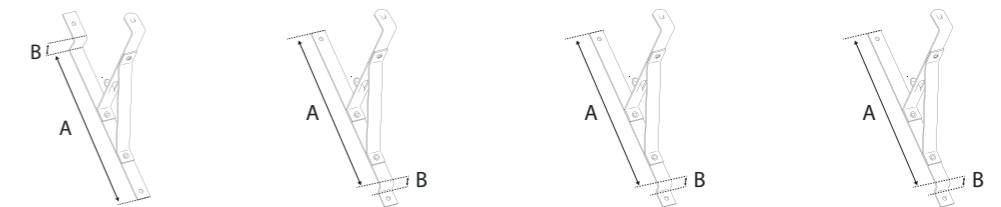

PRODUCT	FIX METAL PANEL	FIX METAL 350	FIX METAL 400	FIX METAL VENEČJA
Page	139	140	140	140
Roof cover type	Panel roof tiles; JANOSIK; METRO SHAKE II, REGLE, PREMIUM; HARNAŠ	Profiled metal roof covering of module lenght 350 mm	Profiled metal roof covering of module lenght 400 mm	Profiled metal roof covering of module VENEČJA 350 mm
Size	A: 370 mm B: 35 mm	A: 350 mm B: 30 mm	A: 400 mm B: 30 mm	A: 350 mm B: 35 mm
RAL colour	Galvanized; RAL: 8004; 8017; 8019; 9005; 6020; 7016; 3009; 3004; 7024	Galvanized; RAL: 8004; 8017; 8019; 9005; 6020; 7016; 3009; 3004; 7024	Galvanized; RAL: 8004; 8017; 8019; 9005; 6020; 7016; 3009; 3004; 7024	Galvanized; RAL: 8004; 8017; 8019; 9005; 6020; 7016; 3009; 3004; 7024
Box	5 pcs.	5 pcs.	5 pcs.	5 pcs.

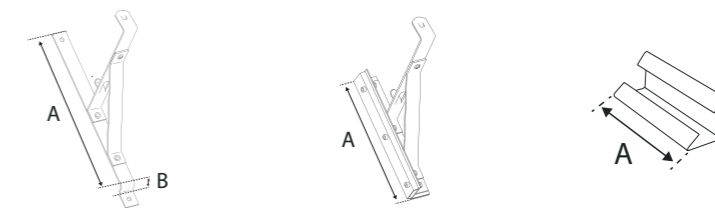

PRODUCT	FIX METAL FINNERA	FIX METAL FLAT	CLIP
Page	140	141	141
Roof cover type	Profiled metal roof covering of module FINNERA 330 mm	Standing-seam metal roofing	-
Size	A: 330 mm B: 30 mm	A: 270 mm	A: 60 mm
RAL colour	Galvanized; RAL: 8004; 8017; 8019; 9005; 6020; 7016; 3009; 3004; 7024	Galvanized; RAL: 8004; 8017; 8019; 9005; 6020; 7016; 3009; 3004; 7024	Galvanized; RAL: 8004; 8017; 8019; 9005; 6020; 7016; 3009; 3004; 7024
Box	5 pcs.	5 pcs.	50 pcs.



## SNOW PROTECTION



PRODUCT	TUBE	FIX TUBE UNI	FIX TUBE DB-DC SHORT	FIX TUBE DB-DC LONG
Page	142	142	142	142
Roof cover type	-	flat roof coverings	concrete roof tiles; ceramic roof tiles	concrete roof tiles; ceramic roof tiles
Size	A: 2,0 m B: $\varnothing$ 32 mm	A: 140 mm	A: 330 mm B: 80 mm	A: 370 mm B: 80 mm
RAL colour	Galvanized; RAL: 8004; 8017; 8019; 9005; 6020; 7016; 3009; 3004; 7024	Galvanized; RAL: 8004; 8017; 8019; 9005; 6020; 7016; 3009; 3004; 7024	Galvanized; RAL: 8004; 8017; 8019; 9005; 6020; 7016; 3009; 3004; 7024	Galvanized; RAL: 8004; 8017; 8019; 9005; 6020; 7016; 3009; 3004; 7024
Box	5 pcs.	5 pcs.	5 pcs.	5 pcs.



PRODUCT	FIX TUBE METAL FLAT	FIX TUBE BIBER	FIX TUBE METAL 350	FIX TUBE METAL 400
Page	143	143	143	143
Roof cover type	Standing-seam metal roofing	ceramic roof tiles - beaver-tail tiles	Profiled metal roof covering of module length 350 mm	Profiled metal roof covering of module length 400 mm
Size	A: 270 mm	A: 480 mm B: 50 mm	A: 350 mm B: 20 mm	A: 400 mm B: 20 mm
RAL colour	Galvanized; RAL: 8004; 8017; 8019; 9005; 6020; 7016; 3009; 3004; 7024	Galvanized; RAL: 8004; 8017; 8019; 9005; 6020; 7016; 3009; 3004; 7024	Galvanized; RAL: 8004; 8017; 8019; 9005; 6020; 7016; 3009; 3004; 7024	Galvanized; RAL: 8004; 8017; 8019; 9005; 6020; 7016; 3009; 3004; 7024
Box	5 pcs.	5 pcs.	5 pcs.	5 pcs.



PRODUCT	FIX TUBE METAL VENECJA	FIX TUBE METAL FINNERA	FIX TUBE METAL JANOSIK	FIX TUBE METAL GERMANIA
Page	144	144	144	144
Roof cover type	Profiled metal roof covering of module VENECJA 350 mm	Profiled metal roof covering of module FINNERA 330 mm	Profiled metal roof covering of module JANOSIK 380 mm	Profiled metal roof covering of module GERMANIA SIMETRIC
Size	A: 350 mm B: 35 mm	A: 330 mm B: 30 mm	A: 380 mm B: 35 mm	A: 350 mm B: 30 mm
RAL colour	Galvanized; RAL: 8004; 8017; 8019; 9005; 6020; 7016; 3009; 3004; 7024	Galvanized; RAL: 8004; 8017; 8019; 9005; 6020; 7016; 3009; 3004; 7024	Galvanized; RAL: 8004; 8017; 8019; 9005; 6020; 7016; 3009; 3004; 7024	Galvanized; RAL: 8004; 8017; 8019; 9005; 6020; 7016; 3009; 3004; 7024
Box	5 pcs.	5 pcs.	5 pcs.	5 pcs.

PRODUCT	BLOCK UNI	CLIP TUBE	END TUBE
Page	146	145	145
Size	-	-	-
RAL colour	Galvanized; RAL: 8004; 8017; 8019; 9005; 6020; 7016; 3009; 3004; 7024	9005	9005
Box	10 pcs.	10 pcs.	10 pcs.

The list of producers of roofing covers is on pages 146-149 \*\* on order

## SNOW PROTECTION

PRODUCT	SNOWSTOP	SNOWSTOPPER SET
Page	154-155	156-157
Roof cover type	depending on the model*	depending on the model*
Size	in case of a model*	1,0 m; 2,0 m; 3,0 m
RAL colour	Galvanized; RAL: 8004; 8017; 8019; 9005; 6020; 7016; 3009; 3004; 7024	Galvanized; RAL: 8004; 8017; 8019; 9005; 6020; 7016; 3009; 3004; 7024
Box	100 pcs.	1 set
Pallet	3 000 pcs.	12 sets

## ROOF SAFETY

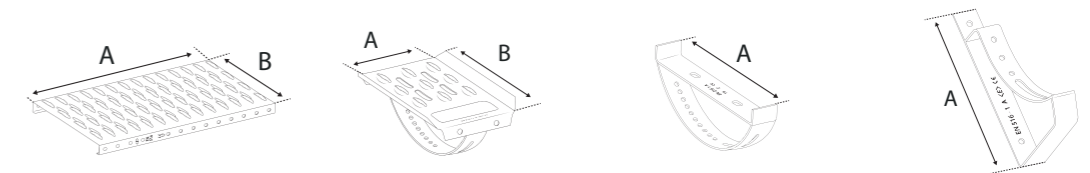

PRODUCT	PLATFORM	STEP	GRIP	SUPPORT UNI
Page	159	159	159	160
Roof cover type	-	-	-	flat roof coverings
Size	A: 0,4 m; 0,6 m; 0,8 m; 1,0 m; 2,0 m; 3,0 m** B: 250 mm	A: 170 mm B: 250 mm	A: 254 mm	A: 270 mm
RAL colour	Galvanized; RAL: 8004; 8017; 8019; 9005; 6020; 7016; 8012; 3004; 7024	Galvanized; RAL: 8004; 8017; 8019; 9005; 6020; 7016; 8012; 3004; 7024	Galvanized; RAL: 8004; 8017; 8019; 9005; 6020; 7016; 8012; 3004; 7024	Galvanized; RAL: 8004; 8017; 8019; 9005; 6020; 7016; 8012; 3004; 7024
Box	4 pcs.	10 pcs.	10 pcs.	5 pcs.

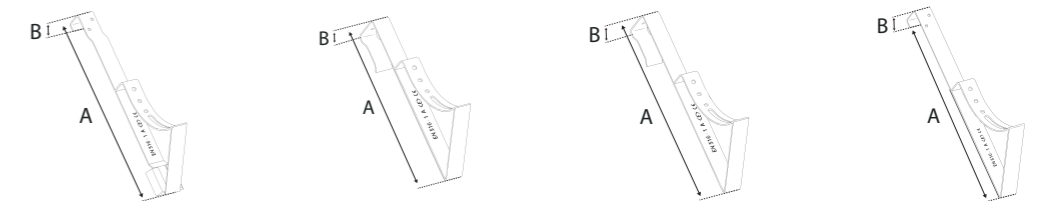

PRODUCT	SUPPORT DB-DC WEST	SUPPORT DB-DC SHORT	SUPPORT DB-DC LONG	SUPPORT BIBER WEST
Page	161	161	161	161
Roof cover type	concrete roof tiles; ceramic roof tiles	concrete roof tiles; ceramic roof tiles	concrete roof tiles; ceramic roof tiles	ceramic roof tiles - beaver-tail tiles
Size	A: 485 mm B: 55 mm	A: 400 mm B: 50 mm	A: 450 mm B: 50 mm	A: 480 mm B: 50 mm
RAL colour	Galvanized; RAL: 8004; 8017; 8019; 9005; 6020; 7016; 8012; 3004; 7024	Galvanized; RAL: 8004; 8017; 8019; 9005; 6020; 7016; 8012; 3004; 7024	Galvanized; RAL: 8004; 8017; 8019; 9005; 6020; 7016; 8012; 3004; 7024	Galvanized; RAL: 8004; 8017; 8019; 9005; 6020; 7016; 8012; 3004; 7024
Box	10 pcs.	10 pcs.	10 pcs.	10 pcs.

\* The list of available models is at pages 148-153 \*\* on order The list of producers of roofing covers is on pages 166-169



## ROOF SAFETY

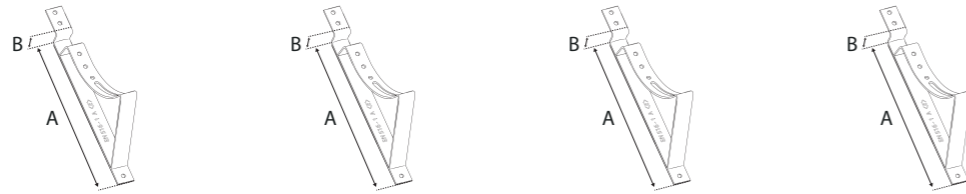

PRODUCT	SUPPORT METAL DECRA STANDARD	SUPPORT METAL DECRA TYSENIA	SUPPORT METAL DECRA SAVANNA	SUPPORT METAL JANOSIK
Page	162	162	162	164
Roof cover type	Profiled metal roof covering of module DECRA	Profiled metal roof covering of module DECRA TYSENIA	Profiled metal roof covering of module DECRA SAVANNA	Profiled metal roof covering of module JANOSIK
Size	A: 350 mm B: 20 mm	A: 350 mm B: 30 mm	A: 350 mm B: 35 mm	A: 380 mm B: 35 mm
RAL colour	Galvanized; RAL: 8004; 8017; 8019; 9005; 6020; 7016; 8012; 3004; 7024	Galvanized; RAL: 8004; 8017; 8019; 9005; 6020; 7016; 8012; 3004; 7024	Galvanized; RAL: 8004; 8017; 8019; 9005; 6020; 7016; 8012; 3004; 7024	Galvanized; RAL: 8004; 8017; 8019; 9005; 6020; 7016; 8012; 3004; 7024
Box	10 pcs.	10 pcs.	10 pcs.	10 pcs.



PRODUCT	SUPPORT METAL 350	SUPPORT METAL 400	SUPPORT METAL VENECJA	SUPPORT METAL FINNERA
Page	164	164	164	164
Roof cover type	Profiled metal roof covering of module lenght 350 mm	Profiled metal roof covering of module lenght 400 mm	Profiled metal roof covering of module VENECJA 350 mm	Profiled metal roof covering of module FINNERA 330 mm
Size	A: 350 mm B: 20 mm	A: 400 mm B: 20 mm	A: 350 mm B: 35 mm	A: 330 mm B: 30 mm
RAL colour	Galvanized; RAL: 8004; 8017; 8019; 9005; 6020; 7016; 8012; 3004; 7024	Galvanized; RAL: 8004; 8017; 8019; 9005; 6020; 7016; 8012; 3004; 7024	Galvanized; RAL: 8004; 8017; 8019; 9005; 6020; 7016; 8012; 3004; 7024	Galvanized; RAL: 8004; 8017; 8019; 9005; 6020; 7016; 8012; 3004; 7024
Box	10 pcs.	10 pcs.	10 pcs.	10 pcs.



PRODUCT	SUPPORT METAL GERMANIA	SUPPORT METAL FLAT	LINK	VISTA
Page	165	165	160	165
Roof cover type	Profiled metal roof covering of module GERMANIA SIMETRIC 350 mm	Standing-seam metal roofing	-	-
Size	A: 350 mm B: 30 mm	A: 270 mm	A: 180 mm	A: 45 cm B: 55 cm A: 45 cm B: 73 cm A: 48 cm B: 90 cm
RAL colour	Galvanized; RAL: 8004; 8017; 8019; 9005; 6020; 7016; 8012; 3004; 7024	Galvanized; RAL: 8004; 8017; 8019; 9005; 6020; 7016; 8012; 3004; 7024	Galvanized; RAL: 8004; 8017; 8019; 9005; 6020; 7016; 8012; 3004; 7024	7043
Box	10 pcs.	10 pcs.	10 pcs.	-
Pallet	-	-	-	48 x 90 cm: 10 pcs. others - 11 pcs.

## ROOF SAFETY

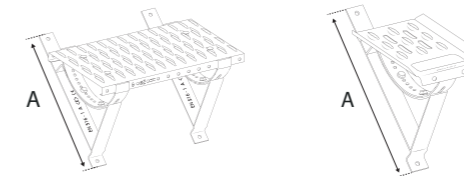

PRODUCT	PLATFORM SET	STEP SET
Page	170-171	172-173
Roof cover type	depending on the model*	depending on the model*
Size	A: 0,4 m; 0,6 m; 0,8 m B: depending on the model*	A: depending on the model*
RAL colour	Galvanized; RAL: 8004; 8017; 8019; 9005; 6020; 7016; 8012; 3004; 7024	Galvanized; RAL: 8004; 8017; 8019; 9005; 6020; 7016; 8012; 3004; 7024
Box	1 set	1 set
Pallet	0,4 m: 60 sets 0,8 m: 40 sets	50 sets

## FOUNDATION FOILS

PRODUCT	GEO 8 ECO	GEO 8 S	GEO 8 TEX	GEO 20 ECO
Page	167	168	169	170
Mass per unit	ca. 400 g/m <sup>2</sup> ca. 500 g/m <sup>2</sup> ca. 600 g/m <sup>2</sup> ca. 800 g/m <sup>2</sup> ca. 1000 g/m <sup>2</sup>	ca. 400 g/m <sup>2</sup>	-	-
Compression strength	ca. 200 kN/m <sup>2</sup>	ca. 200 kN/m <sup>2</sup>	ca. 300 kN/m <sup>2</sup>	ca. 180 kN/m <sup>2</sup>
Roll size	0,5 m; 1,0 m; 1,5 m; 2,0 m; 2,5 m; 3,0 m**; 4,0 m** x 20 rm	0,5 m; 1,0 m; 1,5 m; 2,0 m x 20 rm	2,0 m x 20 rm	1,9 m x 20 rm
Extrusion heigh	8 mm	8 mm	8 mm	20 mm
Extrusion number	1860/m <sup>2</sup>	2115/m <sup>2</sup>	1710/m <sup>2</sup>	-
Temperature resistance	ca.-40°C to +80°C	ca.-30°C to +80°C	ca.-30°C to +80°C	ca.-30°C to +80°C
Pallet	0,5 m - 60 rolls 1,0 m - 30 rolls other - 15 rolls	0,5 m - 48 rolls 1,0 m - 24 rolls other - 12 rolls	6 rolls	5 rolls

PRODUCT	GEO 20 GARDEN	GEO GARDEN DUO	MAUER PVC	GEO MATT
Page	171	172	173	174
Mass per unit	-	HDPE: 1 kg/m <sup>2</sup> PP: 100 g/m <sup>2</sup>	ca. 1,60 kg/m <sup>2</sup>	ca. 300 g/m <sup>2</sup>
Compression strength	ca. 180 kN/m <sup>2</sup>	ca. 180 kN/m <sup>2</sup>	-	-
Extrusion heigh	20 mm	20 mm	-	-
Roll size	2,0 m x 20 rm	1,9 m x 20 rm	0,25 m; 0,30 m; 0,40 m; 0,50 m; 0,60 m; 1,0 m x 30 rm	1,4 m x 25 rm 1,4 m x 30 rm
Thickness	-	-	ca. 1 mm	ca. 8 mm
Temperature resistance	ca.-30°C to +80°C	ca.-30°C to +80°C	ca.-30°C to +80°C	ca.-30°C to +80°C
Pallet	5 rolls	5 rolls	0,25 m: 80 rolls 0,30 m; 0,40 m: 60 rolls 0,50 m; 0,60 m: 40 rolls 1,0 m: 20 rolls	9 rolls



## FOUNDATION FOILS

PRODUCT	GEO TEX
Page	175
Mass per unit	ca. 100 g/m <sup>2</sup>
Water-tightness	ca. 0,07 m/s
Roll size	0,50 m; 1,0 m; 1,5 m; 2,0 m x 50 rm
Pallet	0,5 m: 96 rolls 1,0 m: 48 rolls other: 24 rolls

## FOUNDATION FOILS - ACCESSORIES

PRODUCT	GEO LINE	GEO NAIL	GEO BUTYL	GEO BAND
Page	177	177	177	177
Type of tape	-	-	double-sided	sealing
Roll size	-	-	15 mm x 25 rm	120 mm x 50 rm
Lenght	2 rm	40 mm	-	-
Application temperature	-	-	>5°C	-
Box	25 pcs.	100 pcs.	16 rolls	1 roll
Pallet	3750 pcs.	125 000 pcs.	480 rolls	120 rolls





  
**24-48h - National**  
**7 days - Export**

# Logistics

• Our deliveries are realized by the road, by railway and by maritime.

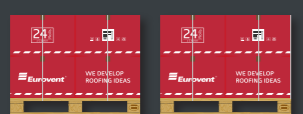

EUR Pallet 120 cm x 80 cm



Bus/furgon up to 4 pallets



Delivery truck up to 10 pallets

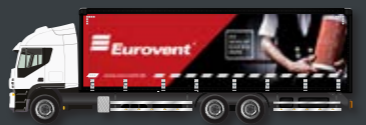

Lorry up to 18 pallets



Semitrailer up to 33 pallets



Tandem truck up to 38 pallets



Container 20ft up to 11 pallets



Container 40ft up to 25 pallets

\* The presented number of pallets is a maximum number of Euro-pallets without stacking, the final logistics is established by the Eurovent® consultant in agreement with the client.

# YourBrand

The Your Brand program is dedicated to the most demanding clients, who we offer preparation of products from our portfolio in accordance with their private brand.

## From the project to realization

According a client's desires, we are able to perform individual indications on products, as well as labelling and a package corresponding to the presented demands.

## Join to the best ones

There are manufacturers of roof coverings, independent distributors, sales networks and building markets among our clients, who we prepare membranes and roof accessories for.





WE  
DEVELOP  
ROOFING  
IDEAS



**BLACK**

VAPOUR BARRIER PRODUCTS

VAPOUR BARRIER MEMBRANES  
VAPOUR BARRIER FOILS

**RED**

BREATHABLE PRODUCTS

ROOFING MEMBRANES  
HOUSEWRAPS  
ROOFING FOILS

**NEW 2020**

new packaging designs Eurovent!

In response to growing customer needs and with care of high quality of our products we are happy to publish the new packaging designs for membranes and films of the Eurovent® brand.

Red roll - breathable products

Black roll - vapour barrier products

**VAPOUR BARRIER PRODUCTS**



OLD 2014

NEW 2020

**BREATHABLE PRODUCTS**



OLD 2014

NEW 2020

















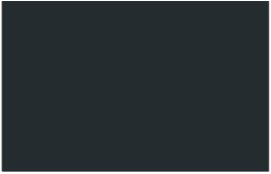

**Construction of a new label**

- 1 Large product name, weight and type.
- 2 Technical data, barcode and-QR code with link for the product website.

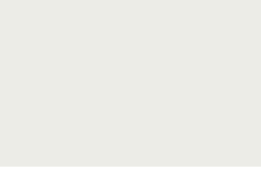

# COLOUR

Colour scheme available in a standard for the roof accessories offered by us.

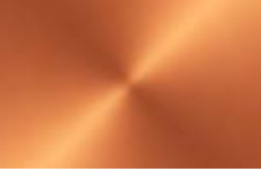
			
RAL 6020 green B. C.	RAL 3004 cherry A. C.	RAL 3011 cherry A..	RAL 3013 cherry A. B.
			
RAL 8004 wall red A. B. C.	RAL 3009 chestnut B. C.	RAL 8015 chestnut A.	RAL 8017 brown A. B. C.
			
RAL 8019 brown A. B.	RAL 7021 anthracite A. B.	RAL 7016 anthracite B. C.	RAL 7024 graphite C.
			
RAL 9007 lead A.	RAL 7036 grey B.	RAL 9006 aluminum A.	RAL 9003 white A.
			
RAL 9005 black A. B. C.	Zn galvanized C.	Cu copper A.	

























**A.**  
ridge; chimney; eaves; valley

**B.**  
systems of accesories  
for ventilation

**C.**  
roof safety;  
snow protection

# ICONOGRAPHY

Icons describing the most important technical parameters of our products.

	Mass per unit		Sd value		Cardboard/ Package
	Tape size		Roll size		Pallet
	Model		Width		Capacity
	Width of cantilever		Height		Diameter
	Temperature		Thickness		Colour
	Compression strength		Size		Board size
	Water permeability		Extrusion height		Extrusion number
	Reaction to fire		Temperature resistance		Noise reduction

All the information has been advertised in good faith, on the basis of our best knowledge, research and a whole range of experiences. The information does not constitute any sales proposal within the meaning of Civil Code.

We reserve the right of possible technical changes as well as certain mistakes and errors in the print. The reprint edition, also in the form of extracts, only with the Eurosystem Polska Sp. z o.o. Sp. K consent.

Print: Eurovent® 07/2020 Catalogue 2020 A4:v7



---

[www.eurovent.de](http://www.eurovent.de)