



VENTING SYSTEM VENTOS X

WE
DEVELOP
ROOFING
IDEAS



VENTOS X

ROOFING VENT

Eurovent® VENTOS X is an advanced roofing vent with the venting diameter of 170 mm and the venting entry of 150 mm.

Dedicated design effectively supports ventilation using the energy of the wind, ensures correct run of the air through improved capacity of the vent.

It is equipped with the anti condensation system which prevents condensation affecting thermal insulation.

Used as a roof outlet for mechanical and gravity ventilation ducts.

Ø 150 mm

RAL: 8004; 8019; 9005; 8017; 7024; 3009; 7021; 7036; 6020

1 set

36 sets

› Eurovent® VENTOS X – metal sheet roofing cover

- 1 Eurovent® VENTOS X METAL
- 2 Eurovent® STRONG
- 3 Eurovent® PUR
- 4 Thermal insulation
- 5 Metal roofing sheets

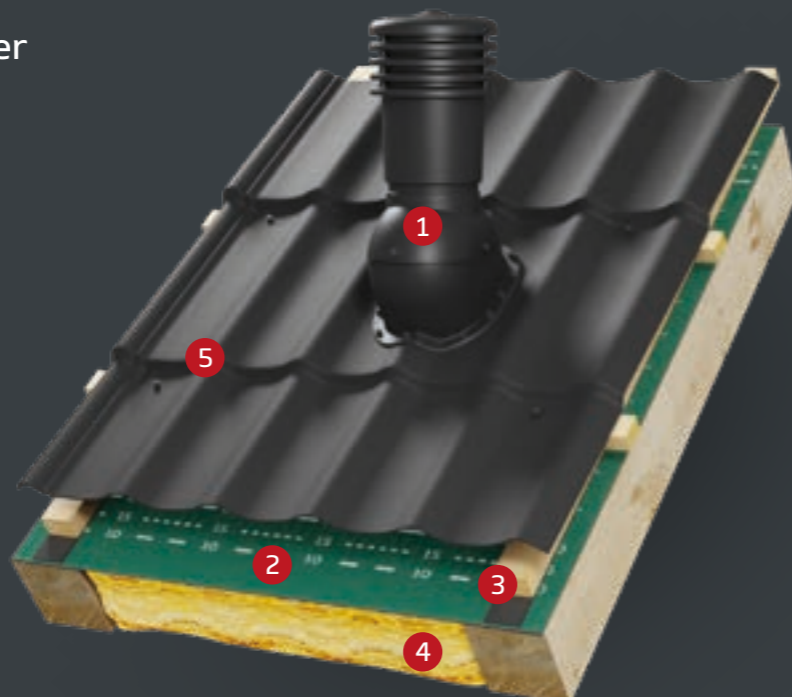

CONSTRUCTION

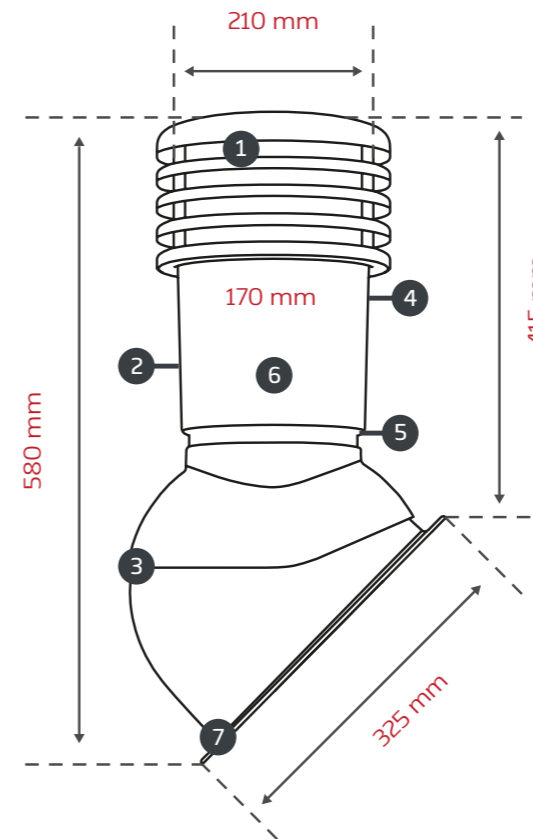

- 1 TOP CAP - a special ring shape with the internal diameter of 210 mm supports gravity ventilation by using the wind energy to increase the run of the air through the venting channel.
- 2 SURFACE - it is made the way it decreases the ability to absorb dust and dirt.
- 3 ADJUSTMENT - the vent enables to control the slope angle related to the roofing cover.
- 4 COLORS - wide range of colours according to popular colours used for the roofing covers.
- 5 ANTICONDENSATION SYSTEM - it has advanced system draining the condense water from the inside to of the venting channel directly onto the roofing cover.
- 6 FLOW - increased air flow through a wide ventilation channel of the diameter of 170 mm.
- 7 BASE PLATE - water tight base plates matching the shapes of different types of the roofing covers.

CERTIFIKÁT

The vent Eurovent® VENTOS X has been approved by a Building Techniques Institute.

ITB-KOT-2019/1007

The comparison chart shows the air flow of the vents with the diameter of 125 and 150 mm.*

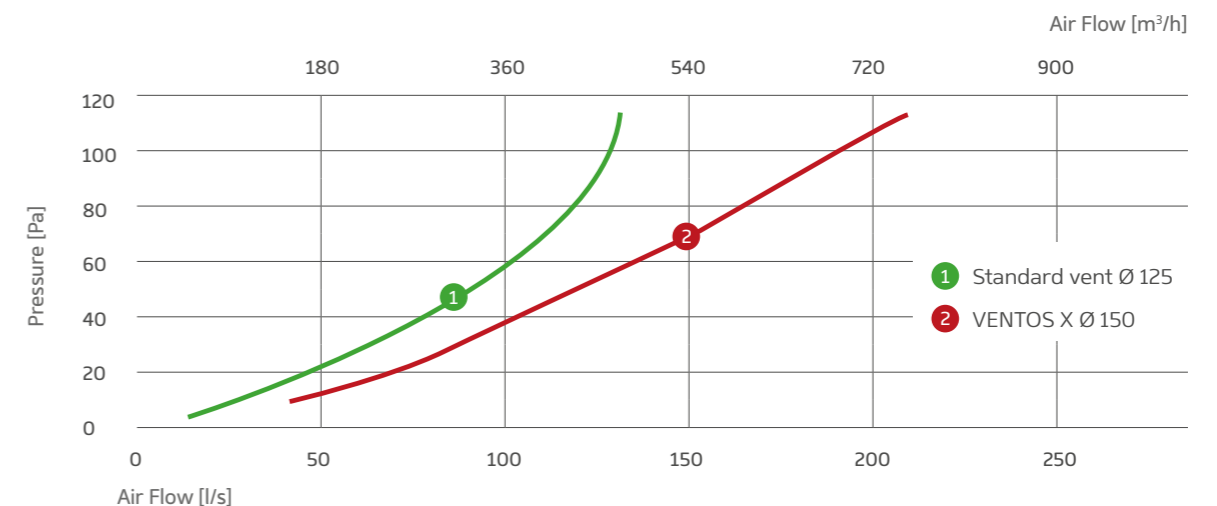

BASE PLATES

Water tight base plates for Eurovent VENTOS X enable easy and quick installation on different kinds of metal roofing sheets and bitumen shingles.



METAL N25



METAL G18



METAL M11



METAL R28



BITU O



METAL F22



METAL W35

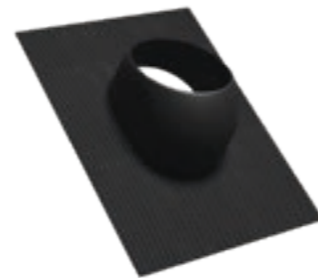

BITU UNI



METAL B26



METAL T35*



METAL T18*



C



R

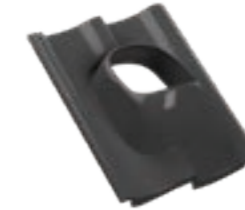

S*

METAL T18; METAL T35

Trapezoidal sheet metal, model 18 and 35 mm

C

BRAAS CELTYCKA
BENDERS PALEMA
NELSKAMP SIGMA

R

BRAMAC ALPEN DACHSTEIN
NELSKAMP FINKENBERGER
BENDERS MECKLENBURGER
PRODACH PODWÓJNA
RZYMSKA
BRAAAS ROMAŃSKA

S

BRAAS BAŁTYCKA S
BRAMAC DONAU DACHSTEIN
NELSKAMP ESÓWKA S
PRODACH PODWÓJNA
ESÓWKA
IBF PODWÓJNA S

*The list of Producers is at pages 122-127

*Following bases T18, T35 and S will be available in the third quarter of 2020 .

*Eurovent® VENTOS X FLAT and SATTOS X will be available in the third quarter of 2020.

› Eurovent® VENTOS X – Trapezoidal sheet metal

- 1 Eurovent® VENTOS X BITU UNI
- 2 Eurovent® XSTRONG
- 3 Eurovent® PUR
- 4 Thermal insulation
- 5 Trapezoidal sheet metal

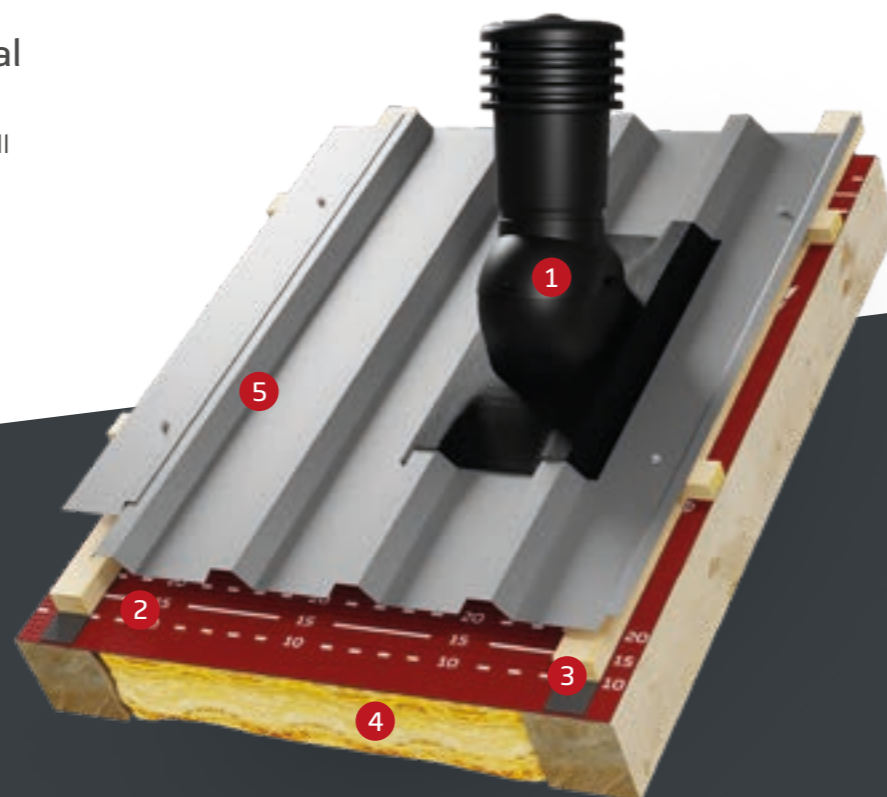

SATTOS X*

- An antenna adapter manufactured from plastic and tipped with a rubber cap.
- Used for mounting antennas with a mast diameter from 15 to 65 mm.
- For sloping roofs covered with all types of roof coverings.



1 set



36 sets



VENTOS X FLAT*

- Air vent slope chimney manufactured from plastic.
- Used for sloping roofs, covered with metal, concrete, ceramic tiles or bituminous shingle.



1 set



96 sets

Sufficient ventilation

Sufficient ventilation in the buildings provides healthy microclimate and good quality of the air in the rooms.

Correctly working ventilation removes out from the interior: CO₂, water vapour, CO, smells, smoke, etc. Prevents mildew growth and other damages caused by the damp.

Properly functioning ventilation does not cause uncontrolled air runs and reduces the need for heat energy thanks to the controlling ability of the venting efficiency, which makes it possible to increase or decrease the exchange of air as required.

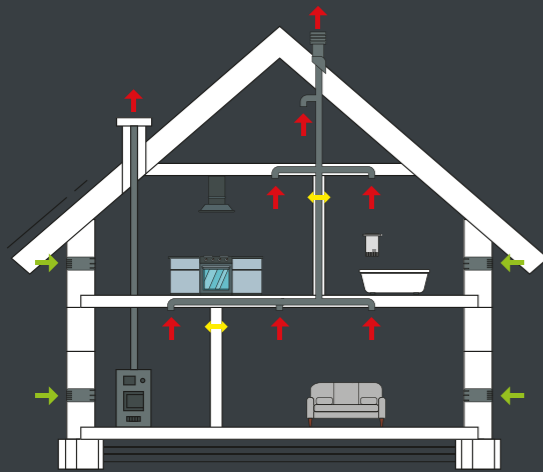

Fresh, oxidized air free of bad smells and pollution.



Adjustable ventilation force, energy saving, noise reduction.



No draughts and heat loss, proper air circulation.



Good feeling, ease of concentration, healthy air in the building.

Unsuccessful ventilation

Unsuccessful ventilation causes cumulation of the unhealthy substances in the air and leads to the unhealthy building syndrom.

There are many dangerous substances that may exist in the air that may influence people's health and their feeling. The most dangerous are water vapour and carbo oxygens. Their high density in the air make headache, feeling of being tired, respiratory system diseases.

Unsuccessful ventilation impacts on the construction of the buldings, causes damp on the substrates, on the thermal insulation and the mildew growth.

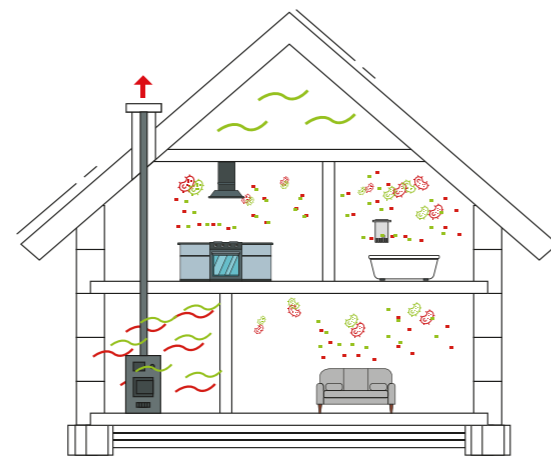

Too big quantity of the water vapour, carbo oxygenes and other gases.



Mildew growth, allergens cumulation, viruses.



Higher relative humidity of the air - water vapour condensation.



Bad feelings, diseases.



FLEXOS X

- Flexible duct made of special plastic finished with reduction of a wide range of diameters.
- Used as an element connecting ventilation chimney for the roof with an attic.
- It has a wide range of lengths and angle adjustment, recommended for demanding connections.

Ø 150/125/120/ /100/80 mm	60 cm	12 pcs.
------------------------------	-------	---------



CLIP X

- Connector made of plastic.
- Enables fast and tight connection of ventilation canals Eurovent® FLEX X and Eurovent® FLEXOS X

Ø 150/150 mm	white	1 pcs.
--------------	-------	--------



FLEX X

- Flexible duct made of special plastic.
- Used as a canal which connects ventilation system in a building with a ventilation chimney.
- It has a wide range of lengths and angle adjustment, recommended for demanding connections.

Ø 150 mm	6 m	12 pcs.
----------	-----	---------



RING X

- Reduction made of plastic.
- Enables direct connection of the Eurovent® FLEX X canal or the Eurovent® VENTOS X ventilation chimney with pipes of 110 mm or 125 mm diameters.

black: Ø 150/110 mm white: Ø 150/125 mm	black; white	1 pcs.
--	-----------------	--------

SEAL EPDM



- Range of seals used for insulating venting channels going through the roof.
- Wide range of available diameters enable application with many types of the pipes and channels.

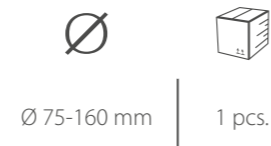

› Application of ducts Eurovent® FLEXOS X and FLEX X

- | | | | |
|----------------------|--------------------|--------------------|----------------------|
| 1 Eurovent® FLEXOS X | 3 Eurovent® RING X | 5 Eurovent® UNISAN | 7 Thermal insulation |
| 2 Eurovent® FLEX | 4 Eurovent® UNO | 6 Eurovent® CLIMA | |

METAL ROOFS - PRODUCERS LIST

Metal roof tiles types	Producer	Plate
A ADA	BLACHY MINDA	N25
ADAMANTE	RUKKI	R28
AGA	BLACHCENTRUM	N25
AGA	LIMBLACH	W35
AGAT	POLSTAL	W35
AKCENT	FINCO-STAL	N25
AKORD	FINCO-STAL	N25
ALFA PREMIUM, ALFA PLUS	BLACHPROFIL 2	N25
ALLANO*	BRATEX	N25
AMALFI PLUS	BLACHDOM PLUS	F22
AQUA	BLOK-BUD/BLOKBLACH/FINNOYA	W35
ARAD OPTIMA/ARAD PREMIUM	PRUSZYŃSKI	R28
ARIA	BUDMAT	W35
ARMANO	DACHY ŁUCZAJ	F22
ASTRA	POLONICA	F22
ATENA	NOWAX	N25
B BANGA	ROZBUD	N25
BARCELONA	DACHY ŁUCZAJ	W35
BELLA	STALHART	W35
BELLA SARA	BUDMAT	N25
BESKID	BLACHDOM PLUS	B26
BESKID PLUS	BLACHDOM PLUS	B26
BETA	BLACHPROFIL 2	N25
BETA	POLSTAL	W35
BIEBRZA	ATESTPOL	N25
BINGO	BLACHODACH	N25
BOLERO	BLACHODACH	B26
BONA/BONA PLUS/BONA LONG	BLACHDOM PLUS	N25
BONITA/BONITA PLUS	DOM-BLACH	N25
BRAVO	BLACHODACH	N25
BRYLANT	BLACHY PIOTRKOWICZ	N25
BURSZTYN	WŁASTAL	N25
C CAMESA	M-BLACH	N25
CARO+/CARO	POLSTAL	N25
CENTRO	BRATEX	B26
CESAR	FINISH PROFILES	W35
CLASSIC	WŁASTAL	N25
D DAKOTA	BLACHSTAL	N25
DANA	GÓRHUT	N25
DECORREY	RUKKI	N25
DIAMENT ECO	BLACHOTRAPEZ	N25
DIAMENT PLUS	BLACHOTRAPEZ	W35
DIANA	NOWAX	W35
DOMINUM PANEL	BLACHY MIDA	M11

* Additional butyl stripes must be ordered

METAL ROOFS – PRODUCERS LIST

Metal roof tiles types	Producer	Plate
D DONA/DONA ECO DUNA DUO	GLINMET/WISTAL ZEPART REGAMET	N25 W35 M11
E ECO ECO NICOL ECO OLIVIA ECOMAX EGERIA ELEGANT ELIOS ELITA EMI ENIGMA* ESKA ESTIMA EURO EUROPA EVELINE	BLACHPROFIL 2 MAX SYSTEM MAX SYSTEM BUDMAX-METAL DACHPOL BORGA POLONICA BLACHSTAL UNBLACH BLACHOTRAPEZ BLACH-POL BLACHOTRAPEZ BLACHPROFIL 2 FLORIAN CENTRUM BLACHY WADOWSKI	N25 N25 W35 N25 G18 N25 W35 W35 N25 W35 N25 Bitu O N25 W35 N25
F FALA FERRERA FINEZJA FINISH/FINISH MAX FINISHDAK FINLANDIA/FINLANDIA DE LUX FINNERA FIŃSKA FLAMENCO FLEX FLORINA FORTE PANEL/ CLASSIC FRANIA SYMETRIC FRIGGE FUTURA	WAT BUDMAT FLORIAN CENTRUM FINISH PROFILES FINISH PROFILES BLACH-POL RUKKI METALEX MIKOŁAJOWICE BLACHODACH PLANNJA FLORIAN CENTRUM FINCO STAL MATPOL RUKKI DACHPOL	W35 W35 G18 N25 N25 F22 F22 W35 F22 F22 N25 R28 G18 M11 M11
G GALLA GALLA GAMMA 25/GAMMA 35MM GERMAN GERMANIA/GERMANIA SIMETRIC* GLORIA GOLD GRYF	GLINMET/WISTAL WAT BLACHPROFIL 2 BLACHSTAL BLACHOTRAPEZ REGAMET TRAFFIC PRUSZYŃSKI	W35 R28 F22 F22 G18 N25 N25 F22
H HALNY HEKTOR	ARCELOR MITTAL (ARMAT) WŁASTAL	N25 N25

* Additional butyl stripes must be ordered

METAL ROOFS – PRODUCERS LIST

Metal roof tiles types	Producer	Plate
H HELIOS HELIOS PLUS HERA HERKULES HESTIA HONORATA HORYZONT HUSARIA	TRANSTAL TRANSTAL BRATEX BLACHSTAL BRATEX SOLAN BALEXMETAL BLACH-POL	N25 N25 N25 F22 N25 W35 N25 G18
I IDA IMPERIA PLUS IRIS	FLORIAN CENTRUM BLACHDOM PLUS DACHPOL	N25 N25 N25
J JANOSIK JOHN STEEL JOKER JOWISZ JULIA	BLACHOTRAPEZ FINISH PROFILES BLACH-DOM DACH-STYL MATPOL	BITU O R28 N25 W35 N25
K KAJA+/KAJA KARA KARAMZYN KARPATIA KIARA KING/KING MAX/KINGSTILE KING/KING PLUS KINGA KINGA/KINGA PLUS KINGAS/KINGAS ECO/KINGAS PLUS KLARA KLAUDIA KOBRA KORONA PLUS KORRA KRISLINE KRON KURPIANKA KWADRA	ROLBUD UNIBLACH TRANSTAL DACH-STYL TRANSBLACH FINISH PROFILES BLACHSTAL STALHART FLORIAN CENTRUM BLACHOTRAPEZ FLORIAN CENTRUM LIMBLACH FLORIAN CENTRUM BLACHDOM PLUS TRANSBLACH BLACHY WADOWSKI PRUSZYŃSKI KURPDACH FINCO STAL	N25 W35 F22 F22 W35 N25 N25 N25 N25 N25 W35 N25 N25 N25 N25 W35 W35 N25 N25 N25 N25
L LARGO PANEL/ LARGO CLASSIC LENA/ LENA MAX LENA LIBRA LIDIA LPAL LUNA LUNA	FINCO STAL WAT ZEPART METALMIX FLORIAN CENTRUM LINDAB DISPOL POLONICA	F22 G18 W35 N25 F22 N25 N25 N25

* Additional butyl stripes must be ordered

METAL ROOFS - PRODUCERS LIST

	Metal roof tiles types	Producer	Plate	
M	M35	SOLAN	N25	
	MAGNAT	BUDMAX-METAL	N25	
	MAJA	FLORIAN CENTRUM	R28	
	MAJOR	WAT	N25	
	MALTA	HANBUD	F22	
	MARII	LIMBLACH	G18	
	MARY STEEL/ MARY STEEL L	FINISH PROFILES	F22	
	MAXIMA	REGAMET	F22	
	MAZOWSZANKA	KURPDACH	W35	
	MEGA	LINDAB	W35	
	MERKURY	DACH-STYL	N25	
	METIS	DACHPOL	N25	
	METRUM	FINCO-STAL	F22	
	MILO/ MILO PLUS	TRANSTAL	W35	
	MODENA	STAHLBERG	N25	
	MODERNO	HANBUD	F22	
	MODUŁOWA	ROZBUD	F22	
	MODUS	PRUSZYŃSKI	R28	
	MONA	REGAMET	F22	
	MONTERREY TS 39/ TS 34 FEB FORMA	RUKKI	N25	
	MONZA	GLINMET/WISTAL	W35	
	MURANO	BUDMAT	M11	
	MUSTANG	BLACH-POL	B26	
N	NANO	FINCO STAL	Bitu O	
	NAREW	ATESTPOL	W35	
	NATURA	BLOK-BUD/ BLOKBLACH/ FINNOYA	N25	
	NICOL	MAX SYSTEM	N25	
	NORA	BIAL-MET	N25	
	NORD*	HANBUD	W35	
	NORDA	INTER-MAX	N25	
	NORDICA+/ NORDICA PANEL	BLACHY MINDA	F22	
	NOVA	ROZBUD	W35	
	NOVATIK PREMIUM	NOVATIK	Bitu O	
	O	OLGA	BLACHY PIOTRKOWICZ	N25
OLIMPIA		REGAMET	W35	
OLIVIA		MAX SYSTEM	W35	
OMEGA		BLACHPROFIL 2	W35	
ONYX		BLACHY ZIEMIŃSKI	F22	
OPTIMA ARAD		PRUSZYŃSKI	R28	
OPUS*		BLACHODACH	Bitu O	
P		PANORAMA	BALEXMETAL	F22
		PETRA DUO	REGAMET	G18
	PAULA	DOM-BLACH	W35	
	PERFECTA	STAHLBERG	N25	

* Additional butyl stripes must be ordered

METAL ROOFS - PRODUCERS LIST

	Metal roof tiles types	Producer	Plate	
P	PERŁA	WŁASTAL	N25	
	PERŁA/PERŁA PLUS	BLACHDOM PLUS	W35	
	PIANO CLASSIC/ PIANO PREMIUM	FINCO-STAL	R28	
	PIANO PANEL ESTETICA/ STANDARD	FINCO-STAL	R28	
	PLATINO*/ PLATINO ECO*	BRATEX	N25	
	PLATINIUM/PLATINIUM ECO	TRAFFIC	F22	
	PODLASIE	BIALMET	W35	
	PLATINIUM	ŁUCZAJ	N25	
	POLA	POLSTAL	F22	
	POLARIS	METALMAX	Bitu O	
	POLONIA	KURPDACH	G18	
	PRESTIGE	STAHLBERG	F22	
	PRIMA	BLACH-POL	W35	
	PROXIMA*	METALMIX	N25	
	Q	QUATTRO/ QUATTRO SYMMETRICA	BLACHSTAL	G18
		R	REGENT/ REGENT GRAND	PLANNJA
	REGLE		PRUSZYŃSKI	BITU O
REN	PRUSZYŃSKI		R28	
REVERS	METALEX MIKOŁAJOWICE		B26	
RIKI	VICOR		N25	
ROMA	REGAMET		R28	
ROZALIA	FLORIAN CENTRUM		G18	
RUBIN PLUS	PRUSZYŃSKI		N25	
RZYMSKA	DACH-METAL		W35	
S	SARA		BUDMAT	N25
	SATURN	DACH-STYL	N25	
	SAVANNA	BRATEX	BITU O	
	SCANDIA	METALEX MIKOŁAJOWICE	W35	
	SCANDIC LINE/ SCANDIC MODULAR	PLANNJA	N25	
	SCANDINAVIA	BRATEX	F22	
	SEGMENT	TRANSBLACH	N25	
	SIMELINE	BLACHY WADOWSKI	G18	
	SILVER	TRAFFIC	N25	
	SIÓDEMKA	DACHPOL WŁOSZCZOWA	F22	
	SMART	PLANNJA	N25	
	SOLIS	BLOK-BUD/BLOKBLACH/FINNOYA	F22	
	SONATA	BLACHODACH	W35	
	SPECJAL	BLACHY PIOTRKOWICZ	N25	
	SPEKTRUM	BALEXMETAL	N25	
	STANDARD	ŁUCZAJ	N25	
	STELLA	DISPOL	N25	
SYMETRIA	BLACH-POL	F22		
SYMETRIA	NOWAX	G18		
SYMETRIA DE LUX	BLACH-POL	F22		

* Additional butyl stripes must be ordered

METAL ROOFS - PRODUCERS LIST

Metal roof tiles types	Producer	Plate
S SZAFIR SZKOCKA	PRUSZYŃSKI BLACH-POL	N25 M11
T TAKT TALIA* TANGO TEMIDA TOPAZ TOPLINEL (LPAN) TYSENIA TUR TWIST	FINCO-STAL BLACHOTRAPEZ FINCO-STAL GLINMET/WISTAL WŁASTAL LINDAB BLACHOTRAPEZ PRUSZYŃSKI BLACHODACH	N25 N25 W35 G18 W35 N25 BITU O F22 N25
V VENESSA/VANESSA SIMETRIC VEGA VEGA VELLO VELA VENA* VENECLA VERA VIKA VIKTORIA VIVALDI	DOM-BLACH FINCO-STAL METALMIX BRATEX INTER-MAX HANBUD BUDMAT UNIBLACH VICOR REGAMET ARECO SWEDEN	G18 N25 W35 N25 G18 N25 F22 N25 N25 N25
W WESTA WIKTORIA	INTER-MAX METALEX MIKOŁAJOWICE	W35 N25
X XARA	ZEPART	N25
Z ZEFIR ZET ZUZIA	BUDMAT BLACHPROFIL 2 MATPOL	N25 F22 W35

CONCRETE ROOF TILES - PRODUCERS LIST

Concrete roof tiles types	Producer	Plate
A ALPEN DACHSTEIN	BRAMAC	R
B BAŁTYCKA S	BRAAS	S
C CELTYCKA	Braas	C
D DONAU DACHSTEIN	BRAMAC	S
E ESÓWKA S	NELSKAMP	S
F FINKENBERGER	NELSKAMP	R
M MECKLENBURGER	BENDERS	R
P PALEMA PODWÓJNA RZYMSKA PODWÓJNA ESÓWKA PODÓWJNA S	BENDERS PRODACH PRODACH IBF	C R S S
R ROMAŃSKA	BRAAS	R
S SIGMA	NELSKAMP	C

BITUMEN SHINGLES - MODELS OF PLATE

BITU O

Bitumen shingles
Tar paper
Insulated metal panels;
Standing seam;
Profiled metal sheets;
Flat roofing coverings - others;
-installed on the roof covering

BITU UNI

Trapezoidal sheet metal
-installed on the roof covering

* Additional butyl stripes must be ordered



RAL Colors

The range of colors according to RAL matching the most popular shades of colors used on the slope roofs.

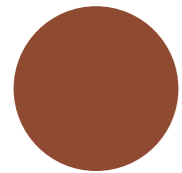

RAL 8004

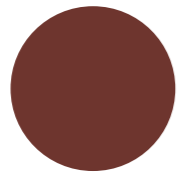

RAL 3009



RAL 8017

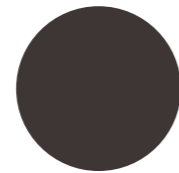

RAL 8019

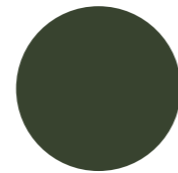

RAL 6020

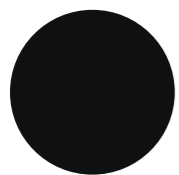

RAL 9005

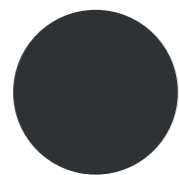

RAL 7021

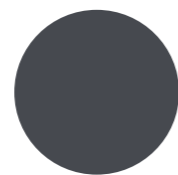

RAL 7024

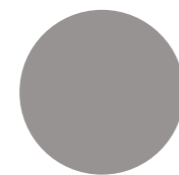

RAL 7036



www.eurovent.de